

2012-2013







1

visual communication

## X-Banner Tudela

X-Banner easily interchangeable graphic system.

**Material:** Silver anodised aluminium.

	QTY	N.W(kg)	G.W(kg)	C.B.M.	Size(mm)
<b>Packing</b>	5	6.75	8.75	0.07	1080x200x300
<b>Uni.</b>	1	1.35	1.75	0.05	1080x30x160

**10.007 600x1595mm**



	QTY	N.W(kg)	G.W(kg)	C.B.M.	Size(mm)
<b>Packing</b>	10	10.6	12.6	0.07	1210x200x290
<b>Uni.</b>	1	1.55	1.95	0.06	1210x40x160

**10.111 600x1800mm**



	QTY	N.W(kg)	G.W(kg)	C.B.M.	Size(mm)
<b>Packing</b>	10	11.75	13.75	0.07	1210x200x290
<b>Uni.</b>	1	1.65	2.05	0.06	1210x40x170

**10.112 800x1800mm**



## X-Banner Valoria



This X-Banner, it's simple to use and provides large visual impact.

**Material:** Aluminium, steel, fiberglass.

	QTY	N.W(kg)	G.W(kg)	C.B.M.	Size(mm)
<b>Packing</b>	5	8.50	9.50	0.08	1360x200x300
<b>Uni.</b>	1	1.70	1.90	0.008	1410x200x30

**10.006 1200x1980mm**



## Economic X-Banner



Lightweight X-Banner tension stand.

**Material:** Fiberglass.

	QTY	N.W(kg)	G.W(kg)	C.B.M.	Size(mm)
<b>Packing</b>	50	15	17.5	0.17	1060x400x400
<b>Uni.</b>	1	0.30	0.35	0.009	1090x140x60

**10.499 Lille - 600x1600mm**



	QTY	N.W(kg)	G.W(kg)	C.B.M.	Size(mm)
<b>Packing</b>	50	17.5	20	0.17	1060x400x400
<b>Uni.</b>	1	0.35	0.40	0.009	1090x140x60

**10.500 Lyon - 700x1800mm**



	QTY	N.W(kg)	G.W(kg)	C.B.M.	Size(mm)
<b>Packing</b>	50	20	22.5	0.19	1200x400x400
<b>Uni.</b>	1	0.40	0.45	0.01	1200x140x60

**10.501 Marseille - 800x2000mm**



# L - BANNER

1

## L-Banner Mestanza



Economical L-Banner.

**Material:** Aluminium, fiberglass.

	QTY	N.W (kg)	G.W (kg)	C.B.M.	Size(mm)
<b>Packing</b>	25	10	11.25	0.073	1060x230x300
<b>Uni.</b>	1	0.40	0.45	0.004	1060x140x30

**10.774**      **600x1600mm**



## L-Banner Navas



Lightweight L-Banner.

**Material:** Aluminium, fiberglass.

	QTY	N.W (kg)	G.W (kg)	C.B.M.	Size(mm)
<b>Packing</b>	10	7	10	0.07	930x340x240
<b>Uni.</b>	1	0.70	1	0.012	1000x110x110

**10.001**      **600x1840mm**



## L-Banner Yesa



Economical and lightweight L-Banner.

**Material:** Aluminium, fiberglass.

	QTY	N.W (kg)	G.W (kg)	C.B.M.	Size(mm)
<b>Packing</b>	20	16	17	0.09	1150x230x350
<b>Uni.</b>	1	0.80	0.85	0.02	1150x135x135

**10.438**      **600x1800mm**



## L-Banner Sella

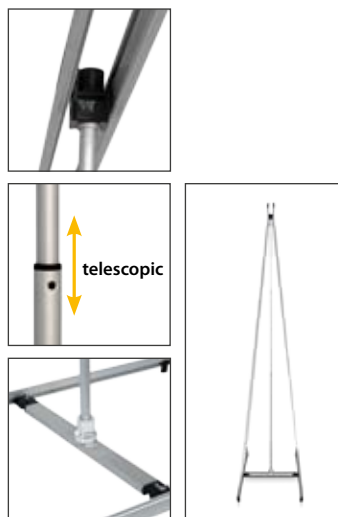

Double sided L-Banner. Economical and lightweight.

**Material:** Aluminium, plastic parts.

	QTY	N.W (kg)	G.W (kg)	C.B.M.	Size(mm)
<b>Packing</b>	5	12.5	15	0.048	1050x230x200
<b>Uni.</b>	1	1.65	1.80	0.009	920x100x100

**10.437**      **800x1800mm**



Double sided

## L-Banner Bonn



Lightweight L-Banner.

**Material:** Aluminium, plastic parts.

	QTY	N.W(kg)	G.W(kg)	C.B.M.	Size(mm)
Packing	1	1.25	1.40	0.023	950x125x200

**10.575**      **800x1800mm**



## L-Banner Heide



Lightweight L-Banner.

**Material:** Aluminium, plastic parts.

	QTY	N.W(kg)	G.W(kg)	C.B.M.	Size(mm)
Packing	1	1.30	1.50	0.023	950x125x200

**10.576**      **900x2150mm**



## L-Banner Rubi - Ribera

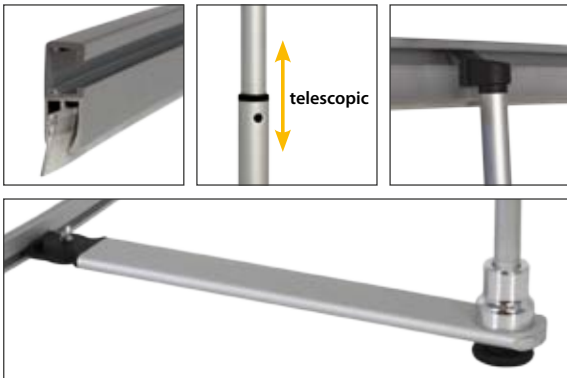

L-Banner concave and convex. Adjustable height.

**Material:** Aluminium, plastic parts.

	QTY	N.W(kg)	G.W(kg)	C.B.M.	Size(mm)
<b>Packing</b>	10	10	12	0.07	930x230x330
<b>Uni.</b>	1	1	1.20	0.01	930x105x105

**10.738 Rubi - 800x1800mm**

**10.739 Ribera - 800x1800mm**

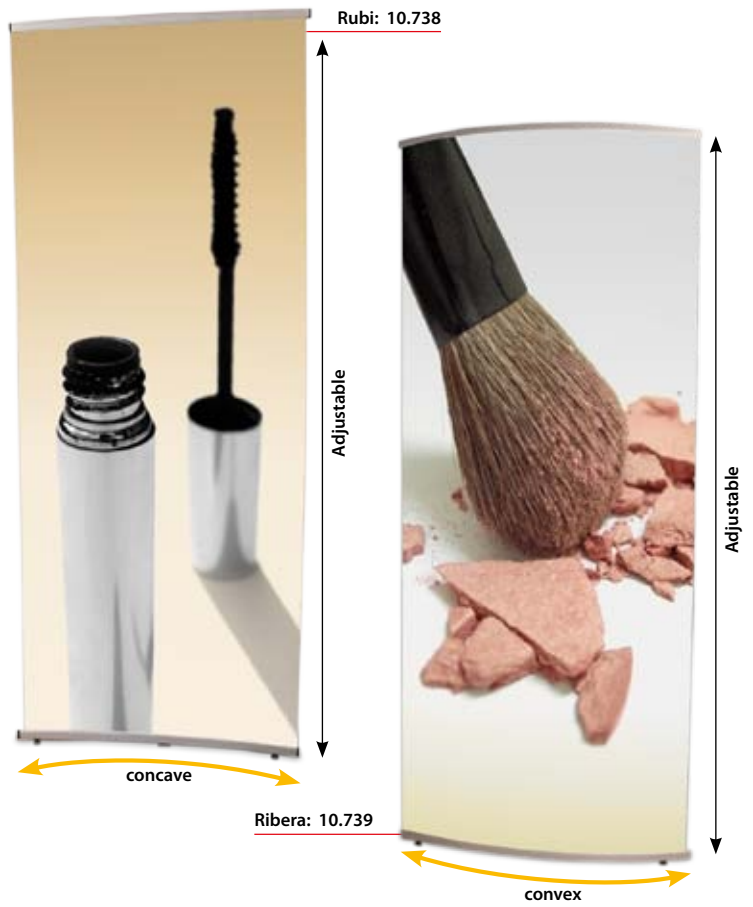

## L-Banner Fabero



Double lightweight L-Banner. Adjustable height.

**Material:** Aluminium, fiberglass.

	QTY	N.W (kg)	G.W (kg)	C.B.M.	Size(mm)
<b>Packing</b>	10	11.5	13	0.102	1350x230x230
<b>Uni.</b>	1	1.15	1.30	0.018	1300x90x160

**10.410 1200x1650mm**

## L-Banner Aldea



Portable Double L-Banner Display. Includes connection-fitting.

**Material:** Aluminium, plastic parts.

	QTY	N.W (kg)	G.W (kg)	C.B.M.	Size(mm)
<b>Packing</b>	5	11	15	0.078	1050x570x130
<b>Uni.</b>	1	2.20	3	0.011	1000x105x105

**10.777 900x2150mm x2**



## Plastic Roll Up Banners

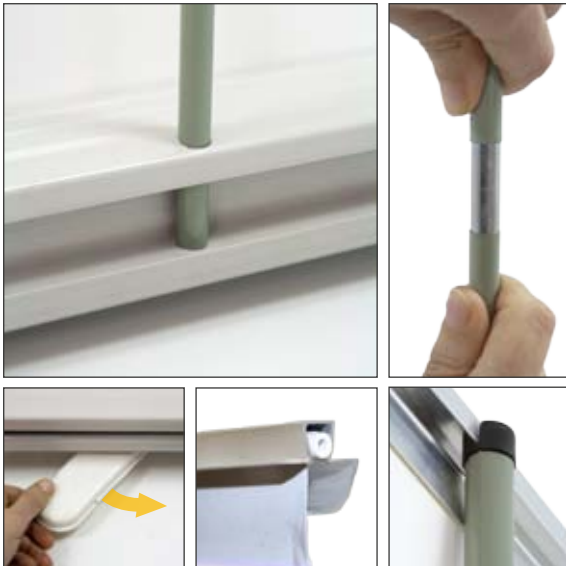
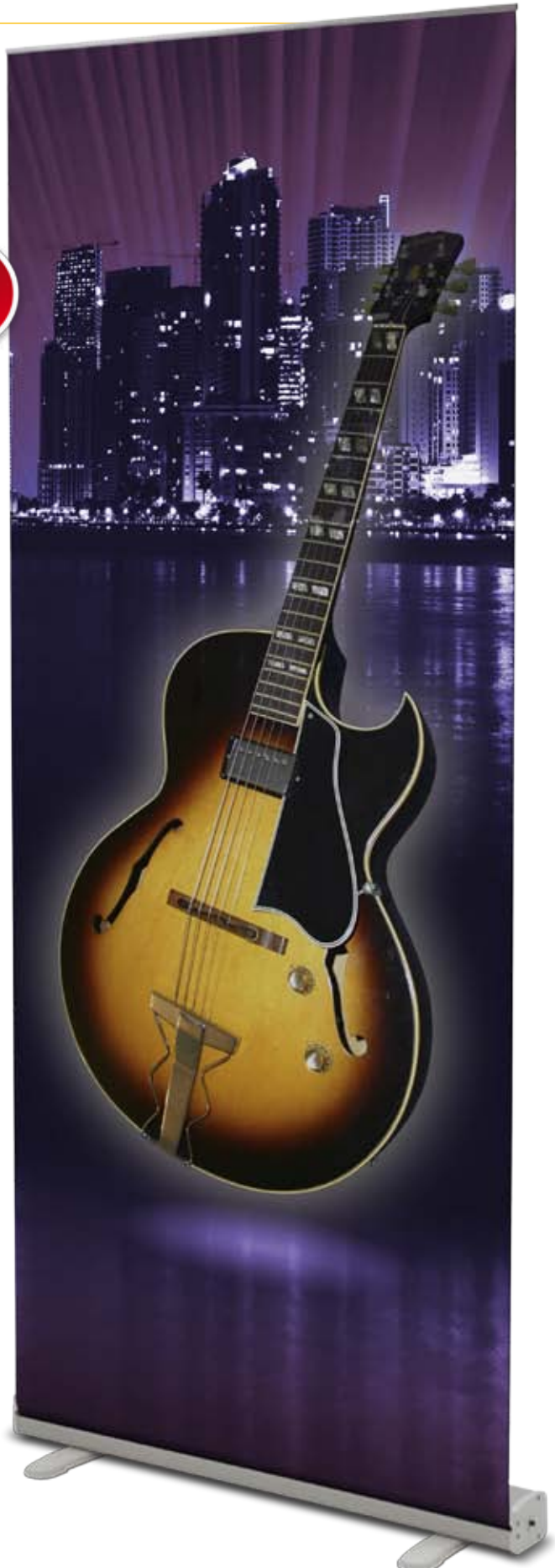
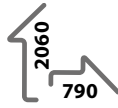

Retractable economical banner stand. Ideal for volume point of sale or exhibitions.

**Material:** Plastic.

	QTY	N.W(kg)	G.W(kg)	C.B.M.	Size(mm)
<b>Packing</b>	1	1.90	2.15	0.005	850x80x80
<b>10.113</b>		<b>790x2060mm</b>			



# ROLL UP BANNER

1

## Roll Up Abadia

Retractable banner stand. No tools required, seconds to put up.

**Material:** Silver anodised aluminium.

	QTY	N.W(kg)	G.W(kg)	C.B.M.	Size(mm)
<b>Packing</b>	12	18	19.50	0.054	300x400x450
<b>Uni.</b>	1	1.35	1.45	0.004	430x95x95

**10.568 400x1560mm**



	QTY	N.W(kg)	G.W(kg)	C.B.M.	Size(mm)
<b>Packing</b>	12	19.20	20.70	0.054	300x400x450
<b>Uni.</b>	1	1.41	1.51	0.004	430x95x95

**10.569 400x1810mm**



	QTY	N.W(kg)	G.W(kg)	C.B.M.	Size(mm)
<b>Packing</b>	12	20.40	21.90	0.054	300x400x450
<b>Uni.</b>	1	1.43	1.53	0.004	430x95x95

**10.570 400x2060mm**

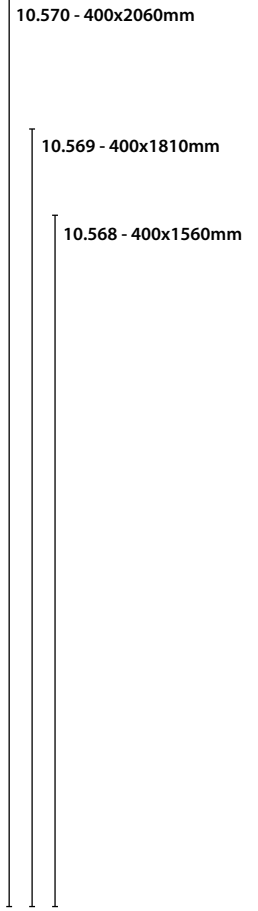

## Roll Up Alzira

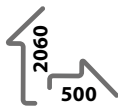

Retractable banner stand. No tools required, seconds to put up.

**Material:** Silver anodised aluminium.

	QTY	N.W (kg)	G.W (kg)	C.B.M.	Size(mm)
<b>Packing</b>	6	12	13.2	0.05	580x340x240
<b>Uni.</b>	1	2	2.20	0.007	580x110x110

**10.093 500x2060mm**



## Roll Up Albares

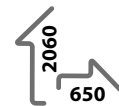

Retractable banner stand. No tools required, seconds to put up.

**Material:** Silver anodised aluminium.

	QTY	N.W (kg)	G.W (kg)	C.B.M.	Size(mm)
<b>Packing</b>	6	11.5	14.5	0.06	340x240x730
<b>Uni.</b>	1	2.05	2.40	0.008	700x110x110

**10.094 650x2060mm**



## Economic Roll Up Alcalá

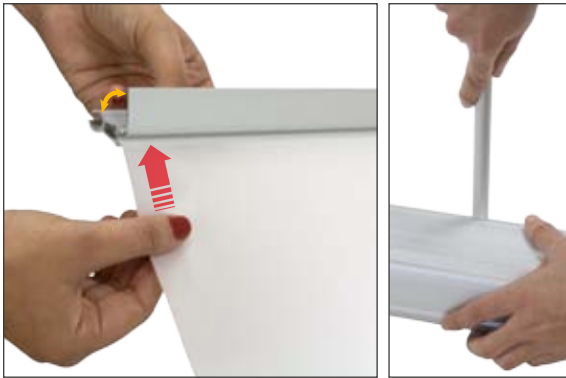
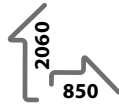

Retractable economical banner stand. Ideal for volume point of sale or exhibitions.

**Material:** Silver anodised aluminium.

	QTY	N.W(kg)	G.W(kg)	C.B.M.	Size(mm)
<b>Packing</b>	10	21	23	0.08	900x475x200
<b>Uni.</b>	1	2	2.25	0.007	875X90x90

10.801

Alcala - 850x2060mm

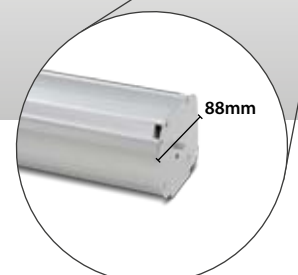

# ROLL UP BANNER

1

## Economic Roll Up Aviles - Ribadeo - Navia



Retractable economical banner stand. Ideal for volume point of sale or exhibitions.

**Material:** Silver anodised aluminium.

	QTY	N.W(kg)	G.W(kg)	C.B.M.	Size(mm)
<b>Packing</b>	6	14.40	15.60	0.063	300x200x1050
<b>Uni.</b>	1	2.30	2.50	0.01	90x90x1040

**10.510 Aviles - 1000x2060mm**



	QTY	N.W(kg)	G.W(kg)	C.B.M.	Size(mm)
<b>Packing</b>	6	18	19.20	0.078	300x200x1300
<b>Uni.</b>	1	3	3.20	0.012	1270x100x95

**10.511 Ribadeo - 1250x2060mm**



	QTY	N.W(kg)	G.W(kg)	C.B.M.	Size(mm)
<b>Packing</b>	6	20.1	21.6	0.093	300x200x1550
<b>Uni.</b>	1	3.60	3.80	0.013	1520x95x95

**10.512 Navia - 1500x2060mm**



## Standard Roll Up Alberca - Alaraz - Alhambra - Almorox



Retractable economical banner stand. Ideal for volume point of sale or exhibitions.

**Material:** Silver anodised aluminium.

	QTY	N.W(kg)	G.W(kg)	C.B.M.	Size(mm)
<b>Packing</b>	6	15	18	0.07	320x230x910
<b>Uni.</b>	1	3	3.20	0.009	890x110x110

**10.016 Alberca - 850x2060mm**



	QTY	N.W(kg)	G.W(kg)	C.B.M.	Size(mm)
<b>Packing</b>	6	16.50	18.90	0.08	320x230x1070
<b>Uni.</b>	1	2.75	3.15	0.011	105x105x1040

**10.365 Alaraz - 1000x2060mm**



	QTY	N.W(kg)	G.W(kg)	C.B.M.	Size(mm)
<b>Packing</b>	6	21.6	25.2	0.12	360x250x1320
<b>Uni.</b>	1	4.20	4.40	0.012	1290x100x100

**10.900 Alhambra - 1250x2060mm**



	QTY	N.W(kg)	G.W(kg)	C.B.M.	Size(mm)
<b>Packing</b>	1	4.10	4.30	0.018	1540x110x110

**10.899 Almorox - 1500x2060mm**

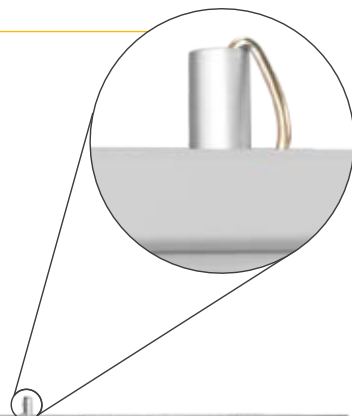

# ROLL UP BANNER

1

## Roll Up Almunia



Retractable banner stand. Easy change exhibition graphics.

**Material:** Silver anodised aluminium.

	QTY	N.W(kg)	G.W(kg)	C.B.M.	Size(mm)
<b>Packing</b>	4	16	20.30	0.10	240x240x1810
<b>Uni.</b>	1	4	4.75	0.025	1785x120x120

**10.095**      **1750x2060mm**



## Roll Up Almansa

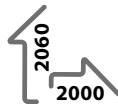

Retractable banner stand. Easy change exhibition graphics.

**Material:** Silver anodised aluminium.

	QTY	N.W(kg)	G.W(kg)	C.B.M.	Size(mm)
<b>Packing</b>	4	17	21.50	0.11	240x240x2060
<b>Uni.</b>	1	4.25	5.05	0.020	100x100x2030

**10.896**      **2000x2060mm**



## Roll Up Alpes



Retractable banner stand. Easy change exhibition graphics.

**Material:** Silver anodised aluminium.

	QTY	N.W(kg)	G.W(kg)	C.B.M.	Size(mm)
<b>Packing.</b>	2	5.8	6.7	0.13	2260x120x240

**10.008**      **2200x2060mm**

## Roll Up Alaska



Retractable banner stand. Easy change exhibition graphics.

**Material:** Silver anodised aluminium.

	QTY	N.W(kg)	G.W(kg)	C.B.M.	Size(mm)
<b>Packing.</b>	1	11.65	13.20	0.048	140x140x2480

**10.956**      **2400x2060mm**

# ROLL UP BANNER

1

## Roll Up Lidine

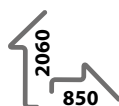
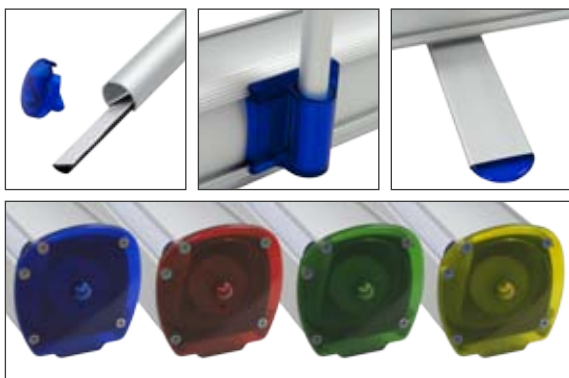

Retractable banner stand. Four different colours for bottom caps.

**Material:** Aluminium.

	QTY	N.W(kg)	G.W(kg)	C.B.M.	Size(mm)
<b>Packing</b>	6	2.83	17	0.09	920x260x380
<b>Uni.</b>	1	2.5	2.83	0.009	890x110x100

10.660

10.661

10.662

10.663 **850x2060mm**

## Roll Up Altea



Retractable banner stand. Black colour.

**Material:** Aluminium.

	QTY	N.W(kg)	G.W(kg)	C.B.M.	Size(mm)
<b>Packing</b>	10	22	24	0.093	210x490x910
<b>Uni.</b>	1	2.20	2.40	0.007	875x90x90

10.680 **850x2060mm**

	QTY	N.W(kg)	G.W(kg)	C.B.M.	Size(mm)
<b>Packing</b>	10	25	26	0.109	210x490x1060
<b>Uni.</b>	1	2.50	2.60	0.011	105x105x1040

10.681 **1000x2060mm**

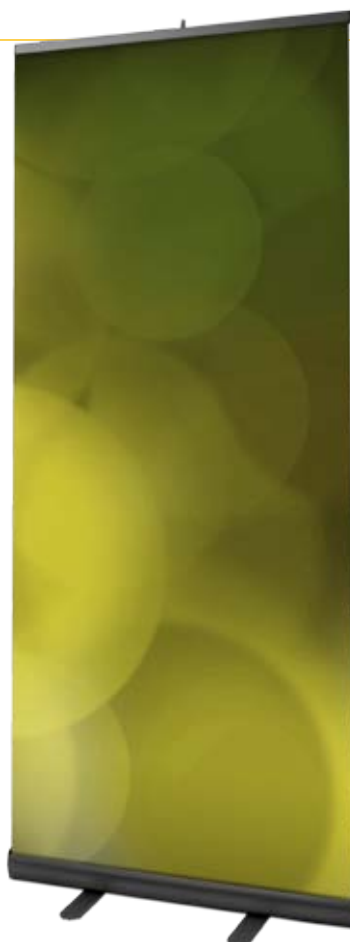



# ROLL UP BANNER

## Roll Up Dehesa



Adjustable

Retractable and telescopic banner stand.

**Material:** Silver anodised aluminium.

	QTY	N.W (kg)	G.W (kg)	C.B.M.	Size(mm)
Packing	6	19.20	23	0.09	360x260x910
Uni.	1	3.15	3.50	0.01	110x110x900

**10.020**      **850x2260mm**



## Roll Up Valdavia



Retractable economical banner stand. Ideal for volume point of sale or exhibitions.

**Material:** Silver anodised aluminium.

	QTY	N.W (kg)	G.W (kg)	C.B.M.	Size(mm)
Packing	6	22.80	25.20	0.07	320x230x910
Uni.	1	3.80	4.20	0.01	890x105x110

**10.017**      **850x2060mm**



## Roll Up Alcoy



Retractable banner stand.

**Material:** Black anodised aluminium.

	QTY	N.W(kg)	G.W(kg)	C.B.M.	Size(mm)
Packing	6	15.0	17.0	0.09	960X260X380
Uni.	1	2.50	2.83	0.007	875X90x90

**10.664**      **850x2060mm**



# ROLL UP BANNER

1

## Roll Up Viterbo

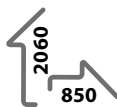

Retractable "Luxury" banner stand with tension regulator. Available in black or white colour.

**Material:** Aluminium.

	QTY	N.W(kg)	G.W(kg)	C.B.M.	Size(mm)
<b>Packing</b>	4	17	20.0	0.126	970x260x500
<b>Uni.</b>	1	4.60	5.0	0.018	920x150x135

10.659  **850x2060mm** 

10.658  **850x2060mm** 

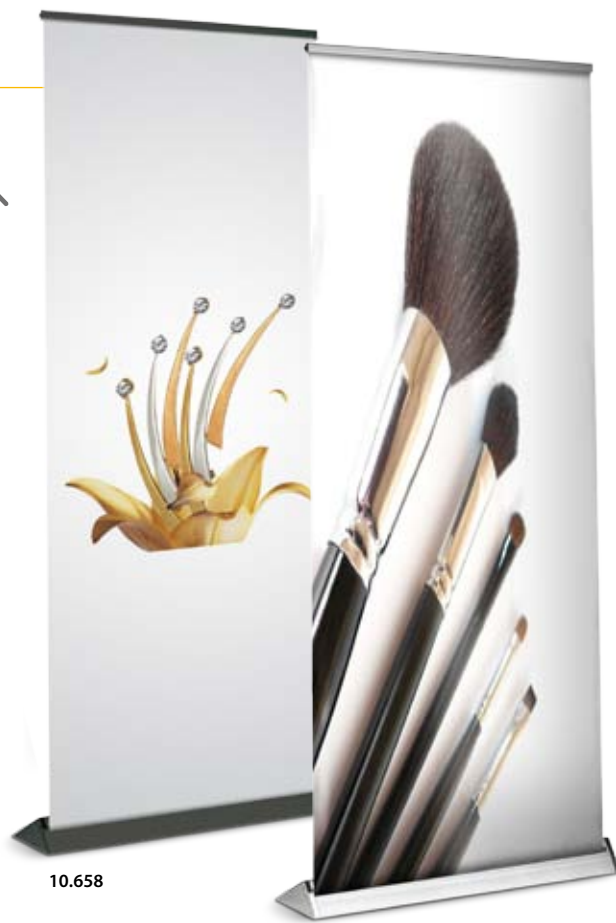

## Roll Up Azutan

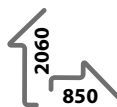
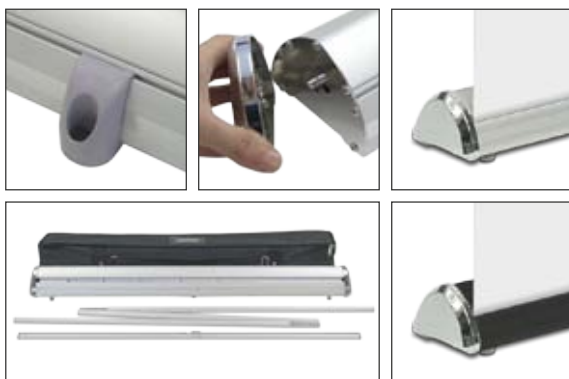

Elegant and fasionable roll up banner. Silver or black.

**Material:** Aluminium.

	QTY	N.W(kg)	G.W(kg)	C.B.M.	Size(mm)
<b>Packing</b>	6	22.8	25	0.104	440x250x950
<b>Uni.</b>	1	3.8	4.1	0.018	920x150x135

10.682  **850x2060mm** 

10.683  **850x2060mm** 

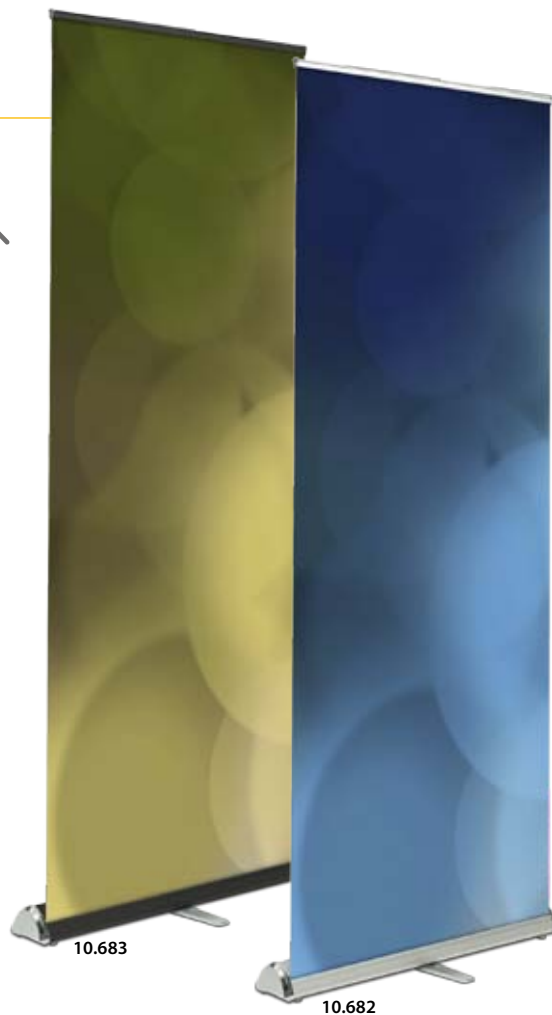

## Roll Up Asti

Retractable "Luxury" banner stand with tension regulator.  
Available in black or white colour.

**Material:** Aluminium.

	QTY	N.W(kg)	G.W(kg)	C.B.M.	Size(mm)
<b>Packing</b>	4	19.6	21	0.126	970x260x500
<b>Uni.</b>	1	4.90	5.20	0.018	920x150x135

**10.657**  **850x2060mm** 

**10.656**  **850x2060mm** 



10.656

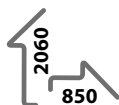

10.657

# ROLL UP BANNER

1

## Roll Up Cervera

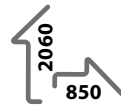

Retractable "Luxury" banner stand with tension regulator.  
Available in black or white colour.

**Material:** Aluminium, plastic parts.

	QTY	N.W(kg)	G.W(kg)	C.B.M.	Size(mm)
<b>Packing</b>	4	18.2	23	0.16	300x530x980
<b>Uni.</b>	1	4.55	5.75	0.018	920x150x135

**10.015**  **850x2060mm** 

**10.955**  **850x2060mm** 

## Roll Up Ribas

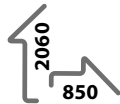

Double sided



Double sided retractable banner stand.

**Material:** Aluminium, plastic parts.

	QTY	N.W (kg)	G.W (kg)	C.B.M.	Size(mm)
<b>Packing</b>	4	22	26.6	0.16	300x530x980
<b>Uni.</b>	1	5.5	6.65	0.03	920x250x135

**10.013** **850x2060mm**  

## Magnet Dispenser

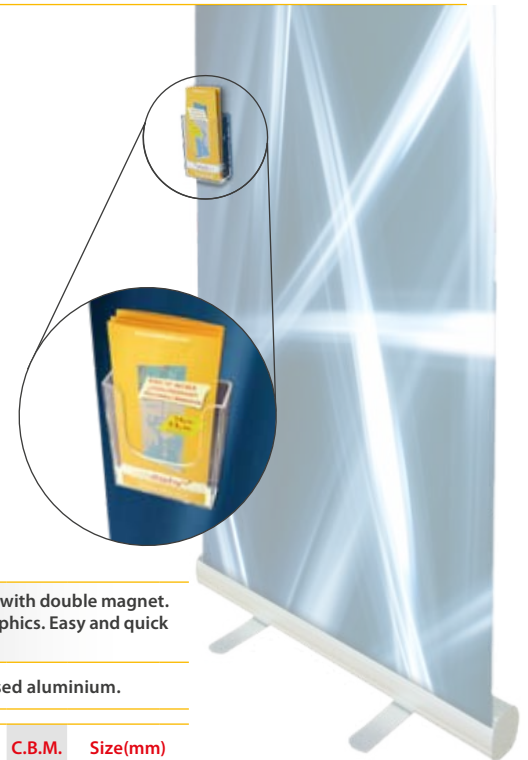

Leaflet dispenser A6 size with double magnet.  
Ideal for use over the graphics. Easy and quick to use.

**Material:** Silver anodised aluminium.

	QTY	N.W (kg)	G.W (kg)	C.B.M.	Size(mm)
<b>Uni.</b>	5	0.85	0.95	0.004	165x130x215

**10.860** **A6** **Pack 5 Uni.** 

## Roll Up Fontiveros

Double sided retractable banner stand.

**Material:** Aluminium, steel.

	QTY	N.W(kg)	G.W(kg)	C.B.M.	Size(mm)
<b>Packing</b>	3	13	15	0.06	350x190x930
<b>Uni.</b>	1	4.40	4.70	0.021	900x180x130
<b>10.014</b>	<b>850x2060mm</b>				



	QTY	N.W(kg)	G.W(kg)	C.B.M.	Size(mm)
<b>Packing</b>	3	15.60	16.80	0.07	1080x350x190
<b>Uni.</b>	1	5.20	5.60	0.024	1040x180x130
<b>10.495</b>	<b>1000x2060mm</b>				



	QTY	N.W(kg)	G.W(kg)	C.B.M.	Size(mm)
<b>Packing</b>	3	20.40	21.60	0.09	1280x350x190
<b>Uni.</b>	1	6.80	7.20	0.025	1280x115x175
<b>10.496</b>	<b>1250x2060mm</b>				



	QTY	N.W(kg)	G.W(kg)	C.B.M.	Size(mm)
<b>Packing</b>	3	24	25.20	0.11	1580x350x190
<b>Uni.</b>	1	8	8.40	0.033	1550x180x120
<b>10.497</b>	<b>1500x2060mm</b>				



## Roll Up Bremen



Roll up with metal table and brochure holder includes.

**Material:** Steel, aluminium, wood.

	QTY	N.W(kg)	G.W(kg)	C.B.M.	Size(mm)
<b>Uni.</b>	1	6.30	6.95	0.037	990x250x150
<b>10.826</b>	<b>905x2060mm</b>				

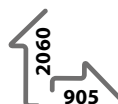

# ROLL UP BANNER

1

## Roll Up XXL Everest

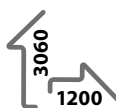

Retractable Roll Higher banner stand. A magnet placed in the top profile allow link to other Roll Up Everest.

**Material:** Silver anodised aluminium.

	QTY	N.W(kg)	G.W(kg)	C.B.M.	Size(mm)
<b>Packing</b>	6	40.2	45	0.15	1260x290x420
<b>Uni.</b>	1	6.50	7.30	0.018	120X120X1260

**10.861**      **1200x3060mm**



## Roll Up Valle

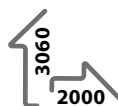

Retractable higher banner stand. Offers large visual impacts in seconds. Telescopic.

**Material:** Steel and aluminium.

	QTY	N.W(kg)	G.W(kg)	C.B.M.	Size(mm)
<b>Packing</b>	1	13	14.80	0.061	2120x180x160

**10.441**      **2000x3060mm**



## Roll Up Max Elda Silver

Retractable higher banner stand. Offers large visual impact in seconds.

**Material:** Black anodised aluminium.

	QTY	N.W(kg)	G.W(kg)	C.B.M.	Size(mm)
<b>Packing</b>	2	12.4	15.85	0.098	1280x320x240
<b>Uni.</b>	1	6.2	7.25	0.042	1270x300x110

**10.934**      **1200x2060mm**



	QTY	N.W(kg)	G.W(kg)	C.B.M.	Size(mm)
<b>Packing</b>	1	7	9.8	0.12	1580x320x240

**10.935**      **1500x2060mm**



	QTY	N.W(kg)	G.W(kg)	C.B.M.	Size(mm)
<b>Packing</b>	1	10.6	14.45	0.19	2480x320x240

**10.936**      **2400x2060mm**



	QTY	N.W(kg)	G.W(kg)	C.B.M.	Size(mm)
<b>Packing</b>	1	28.45	33.20	0.26	3340x320x240

**10.937**      **3200x2060mm**



## Roll Up Max Elda Black

Retractable higher banner stand. Offers large visual impact in seconds.

**Material:** Black anodised aluminium.

	QTY	N.W(kg)	G.W(kg)	C.B.M.	Size(mm)
<b>Packing</b>	2	12.4	15.85	0.098	1280x320x240
<b>Uni.</b>	1	6.2	7.25	0.042	1270x300x110

**10.665**      **1200x2060mm**



	QTY	N.W(kg)	G.W(kg)	C.B.M.	Size(mm)
<b>Packing</b>	1	7	9.8	0.12	1580x320x240

**10.666**      **1500x2060mm**



	QTY	N.W(kg)	G.W(kg)	C.B.M.	Size(mm)
<b>Packing</b>	1	10.6	14.45	0.19	2480x320x240

**10.667**      **2400x2060mm**

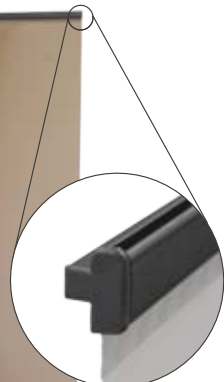

	QTY	N.W(kg)	G.W(kg)	C.B.M.	Size(mm)
<b>Packing</b>	1	28.45	33.20	0.26	3340x320x240

**10.668**      **3200x2060mm**



# ROLL UP OUTDOOR BANNER

1

## Roll Up Exterior Ibiza

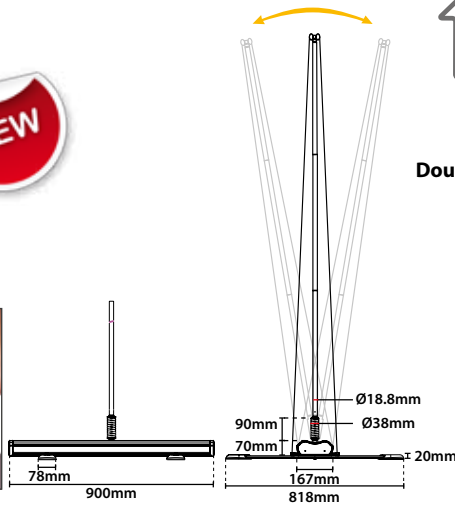

Double sided



Retractable "outdoor" banner stand.

**Material:** Aluminium.

	QTY	N.W(kg)	G.W(kg)	C.B.M.	Size(mm)
<b>Packing</b>	4	7.5	33	0.14	950x320x460

**10.447**      **850x2060mm**



## Roll Up Exterior Ascoli

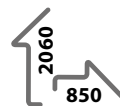
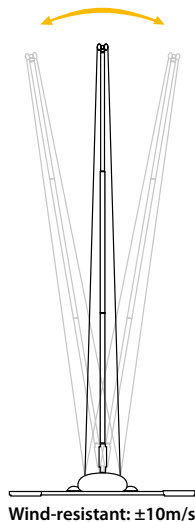

Double sided

Wind-resistant: ±10m/s

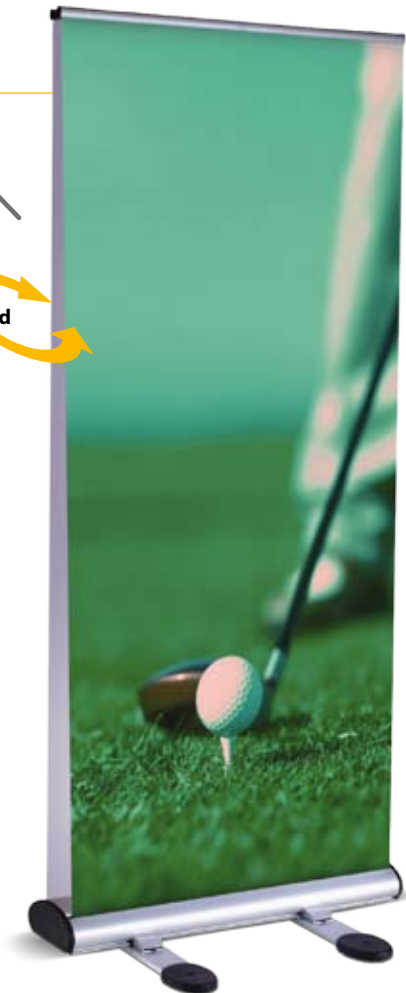

Retractable "outdoor" banner stand.

**Material:** Aluminium.

	QTY	N.W(kg)	G.W(kg)	C.B.M.	Size(mm)
<b>Packing</b>	4	27.60	30.10	0.125	950x455x290
<b>Uni.</b>	2	6.90 6.05	7.60 6.70	0.03 0.025	930x260x125 920x180x150

**10.655**      **850x2060mm**





## Mini Roll Up

Mini retractable desk roller banner stand. A3 and A4 size.

**Material:** Aluminium, plastic parts.

	QTY	N.W (kg)	G.W (kg)	C.B.M.	Size(mm)
<b>Packing</b>	24	9.60	12.20	0.041	300x370x370
<b>Uni.</b>	1	0.40	0.45	0.0014	345x90x45



**10.786**      **Torrigo**    **A3**



	QTY	N.W (kg)	G.W (kg)	C.B.M.	Size(mm)
<b>Packing</b>	24	8.4	9.60	0.03	300x370x280
<b>Uni.</b>	1	0.35	0.40	0.001	260x90x45



**10.787**      **Torrigo**    **A4**



## Mini Roll Up

Double sided



	QTY	N.W (kg)	G.W (kg)	C.B.M.	Size(mm)
<b>Packing</b>	24	13.20	16.05	0.04	370x380x310
<b>Uni.</b>	1	0.60	0.65	0.0014	345x90x45

**10.788**      **Carpio**    **A3**



	QTY	N.W (kg)	G.W (kg)	C.B.M.	Size(mm)
<b>Packing</b>	24	10.80	12.80	0.04	380x380x300
<b>Uni.</b>	1	0.45	0.50	0.001	260x90x45

**10.789**      **Carpio**    **A4**



## Mini X-Banner Tordesillas

Mini desk X-Banner. Green color.

**Material:** Fiber glass, plastic parts.

	QTY	N.W (kg)	G.W (kg)	C.B.M.	Size(mm)
<b>Packing</b>	200	10	14	0.07	500x380x140
<b>Uni.</b>	1	0.05	0.05	0.00045	285x35x45

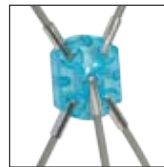
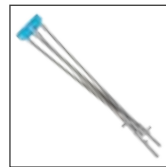

**10.009**      **220x400mm**

## Mini L-Banner Daimiel

Mini desk L-Banner.

**Material:** Fiber glass, plastic parts.

	QTY	N.W (kg)	G.W (kg)	C.B.M.	Size(mm)
<b>Packing</b>	100	9	10	0.033	430x210x370
<b>Uni.</b>	1	0.45	0.45	0.0002	440x20x20

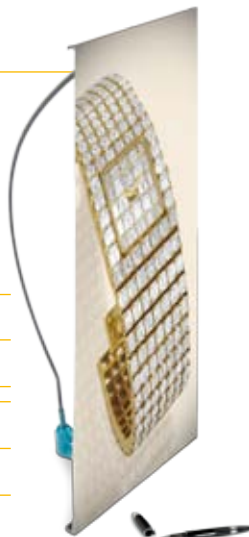

**10.707**      **200x420mm**

## Mini Flying Banner Krakow

Mini desk flying banner.

**Material:** Fiber glass.

	QTY	N.W (kg)	G.W (kg)	C.B.M.	Size(mm)
<b>Uni.</b>	1	0.30	0.35	0.0003	30x12x850



**10.596**      **Height: 550mm**

# SCROLL BANNER

1

## Scroll Banner Pineda



This scrolling banner is electrically powered to make a real eye catching exhibition.

**Material:** Aluminium, plastic parts.

	QTY	N.W(kg)	G.W(kg)	C.B.M.	Size(mm)
<b>Packing</b>	4	19.80	24.60	0.16	300x530x980
<b>Uni.</b>	1	4.95	6.15	0.034	925x280x130

**10.022**      **780x4105mm**



## Scroll Banner Aranda



Single sided wall or ceiling mounted motorised banner system. Includes remote control.

**Material:** Aluminium, plastic parts.

	QTY	N.W (kg)	G.W (kg)	C.B.M.	Size(mm)
<b>Packing</b>	9	17.10	23.85	0.17	400x420x1000
<b>Uni.</b>	1	1.90	2.65	0.014	950x130x115

**10.023**      **800x3300mm**



## Scroll Banner Sarracin



Double sided wall or ceiling mounted motorised banner system. Includes remote control.

**Material:** Aluminium, plastic parts.

	QTY	N.W (kg)	G.W (kg)	C.B.M.	Size(mm)
<b>Packing</b>	6	23.40	29.40	0.19	100x430x440
<b>Uni.</b>	1	3.90	4.90	0.03	980x195x160

**10.024**      **800x3300mm**



## Warta



Stylish motorised mobile banner. One side.

	QTY	N.W(kg)	G.W(kg)	C.B.M.	Size(mm)
Packing	1	5.40	6.50	0.02	720x350x80

10.363

1400mm



## Marin



Mobile banner, the graphic can be single or double face. The plastic base can be filled with water for better stability.

**Material:** Plastic, steel.

	QTY	N.W(kg)	G.W(kg)	C.B.M.	Size(mm)
Packing	1	2.10	2.65	0.03	1050x310x85

10.301

600-900x1200mm



# BAMBOO BANNER

1

## Bamboo X-Banner



Bamboo X-Banner it's easy interchangeable graphic system. This banner it's made of bamboo wood panel. Available in 2 diferents sizes.

**Material:** Bamboo wood.

	QTY	N.W(kg)	G.W(kg)	C.B.M.	Size(mm)
<b>Packing</b>	40	20	22.50	0.13	1130x270x450
<b>Uni.</b>	1	0.50	0.55	0.004	980x105x40

**10.449**      **600x1600mm**



	QTY	N.W(kg)	G.W(kg)	C.B.M.	Size(mm)
<b>Packing</b>	40	34	36	0.15	1180x280x450
<b>Uni.</b>	1	0.85	0.90	0.005	1100x105x40

**10.450**      **800x1800mm**



## Bamboo Roll Up



Retractable banner stand. Easy change exhibiton graphics.

**Material:** Bamboo Wood.

	QTY	N.W (kg)	G.W (kg)	C.B.M.	Size(mm)
<b>Packing</b>	4	12.6	15.2	0.091	900x290x350
<b>Uni.</b>	1	3.15	3.80	0.02	870x170x140

**10.444**      **800x2060mm**



## Pop Up Tabua

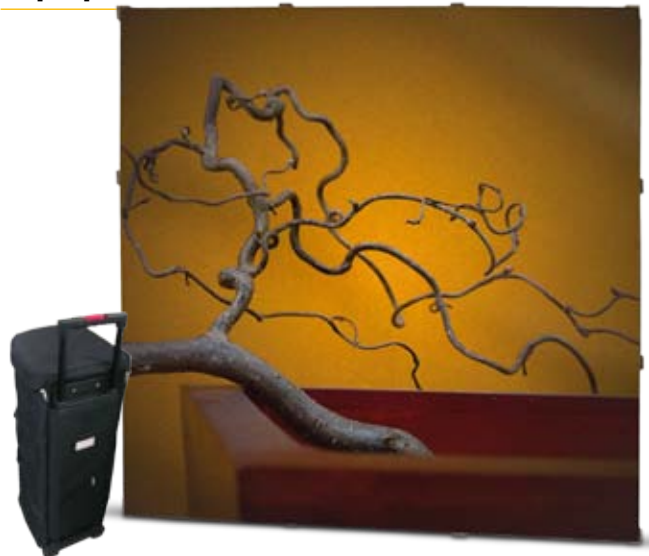

Bamboo Pop-Up (3x3) the graphic is hold in place by velcro. Includes; carry on bag, wood pieces to place the velcro which holds the graphic and bamboo wood structure.

**Material:** Bamboo wood.

	QTY	N.W (kg)	G.W (kg)	C.B.M.	Size(mm)
<b>Uni.</b>	1	14	16	0.18	1080x450x370

**10.448**      **2300x2300mm**

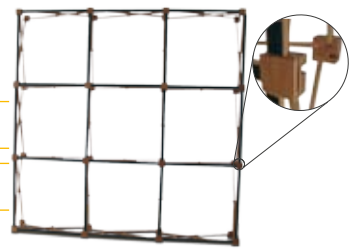

## Moita



Bamboo T-Banner for two side by side graphics, round base, fast and easy to set up.

**Material:** Bamboo wood.

	QTY	N.W (kg)	G.W (kg)	C.B.M.	Size(mm)
Pole	1	1.30	1.35	0.007	660x100x100
Base	1	2.10	2.15	0.006	400x400x40

**10.461 500x1500-1800mm**



## Canecas



Bamboo banner for a single face graphic or double face graphic, square base.

**Material:** Bamboo wood.

	QTY	N.W (kg)	G.W (kg)	C.B.M.	Size(mm)
Packing	1	3.30	3.80	0.06	1200x350x150

**10.462 600x1600mm**



	QTY	N.W (kg)	G.W (kg)	C.B.M.	Size(mm)
Packing	1	3.50	4	0.08	1200x350x200

**10.463 600x1600mm**



## Arbo



Bamboo easel, ideal for the display of graphic frames, can be adjusted for different sizes frames.

**Material:** Bamboo wood.

	QTY	N.W (kg)	G.W (kg)	C.B.M.	Size(mm)
Packing	6	13	15	0.41	1550x600x450
Uni.	1	2.50	3.30	0.003	1425x490x40

**10.452 400x1100mm**



## Moncao



Bamboo folding brochure stand with 6 A4 shelves three on one side and two on the other side.

**Material:** Bamboo wood.

	QTY	N.W (kg)	G.W (kg)	C.B.M.	Size(mm)
Packing	1	5	5.30	0.02	400x305x165

**10.451 270x1500mm**



## Cross Banner Tormes

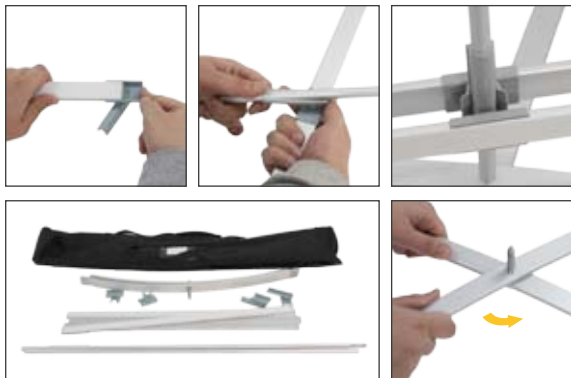

Versatile and cost effective cross banner stand. Double sided. Adjustable height.

**Material:** Aluminium, plastic parts.

	QTY	N.W(kg)	G.W(kg)	C.B.M.	Size(mm)
<b>Packing</b>	10	14.50	18	0.08	980x240x340
<b>Uni.</b>	1	1.45	1.80	0.007	930x85x85

**10.010**      **600x1700mm**



## Cross Banner Almeida



Double-sided banner with two legs for better stability, adjustable height.

**Material:** Aluminium, plastic parts.

	QTY	N.W(kg)	G.W(kg)	C.B.M.	Size(mm)
<b>Packing</b>	10	26	29	0.11	1280x340x240
<b>Uni.</b>	1	2.60	2.90	0.014	1170x120x100

**10.708**      **1000x2000mm**



## Triple Banner Galende



Triple banner, allows the display of two or three graphics in a triangle shape.

**Material:** Aluminium, plastic parts.

	QTY	N.W(kg)	G.W(kg)	C.B.M.	Size(mm)
<b>Packing</b>	5	14	16	0.017	1080x150x400
<b>Uni.</b>	1	2.65	3.05	0.02	650x160x160

**10.012**      **915x2150mm**



	QTY	N.W(kg)	G.W(kg)	C.B.M.	Size(mm)
<b>Packing</b>	5	25	26	0.11	210x310x1700
<b>Uni.</b>	1	3.35	4	0.02	120x120x1400

**10.684**      **600x2985mm**



## Luxe Y-Banner Mudela



Elegant and fashionable Y-Banner.

**Material:** Aluminium.

	QTY	N.W (kg)	G.W (kg)	C.B.M.	Size(mm)
<b>Packing</b>	5	11.5	20	0.123	1210x170x600
<b>Uni.</b>	1	2.30	4	0.02	1195x115x150

**10.885**      **900x2000mm**



## Luxe X-Banner Alba



Modern and elegant X-Banner. It's simple to use and provides large visual impact.

**Material:** Aluminium.

	QTY	N.W (kg)	G.W (kg)	C.B.M.	Size(mm)
<b>Packing</b>	5	11.5	19.75	0.13	1210x170x600
<b>Uni.</b>	1	2.30	3.95	0.019	1195x110x150

**10.886**      **600x1800mm**



# Y - BANNER

1

## Y-Banner Almoguera



Adjustable

Y-Banner adjustable height. Fast to assemble.

**Material:** Aluminium, plastic parts.

	QTY	N.W (kg)	G.W (kg)	C.B.M.	Size(mm)
Packing	6	15	16.80	0.13	1270x380x260
Uni.	1	2.30	2.75	0.018	1250x120x120

10.702

1000x2350mm



## Y-Banner Mondejar



Adjustable

Y-Banner double sided and adjustable height.

**Material:** Aluminium, plastic parts.

	QTY	N.W (kg)	G.W (kg)	C.B.M.	Size(mm)
Packing	6	18	20	0.13	1270x380x260
Uni.	1	2.80	3	0.016	1120x120x120

10.703

1000x2350mm



## Y-Banner Pastrana

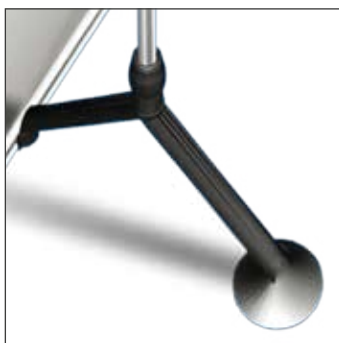

Adjustable

Triple Y-Banner simple to use and provides large visual impact. Includes connection-fitting.

**Material:** Aluminium, plastic parts.

	QTY	N.W(kg)	G.W(kg)	C.B.M.	Size(mm)
Uni.	1	7	8	0.03	1250x240x120

10.704

1000x2350mm x 3pcs





## Golf Banner Silves

Outdoor Fabric A-frame. The system allows a rapid single person set-up. Components:

- Black round bag.
- Hooks.
- Fiber glass pole conector.
- Fiber glass pole.
- Plastic connectors.
- Black margin 60mm width.

**Material:** Fiberglass, plastic parts.

	QTY	N.W(kg)	G.W(kg)	C.B.M.	Size(mm)
<b>Packing</b>	5	12.50	13	0.26	1200x180x1200
<b>Uni.</b>	1	2.50	2.60	0.05	1140x1140x30

**10.426**      **1100x2700mm**

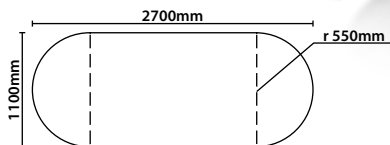

	QTY	N.W(kg)	G.W(kg)	C.B.M.	Size(mm)
<b>Packing</b>	5	8.50	30	0.16	950x950x180
<b>Uni.</b>	1	0.90	1	0.045	950x950x50

**10.427**      **1000x2000mm**

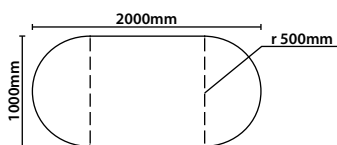

	QTY	N.W(kg)	G.W(kg)	C.B.M.	Size(mm)
<b>Packing</b>	5	7	7.25	0.08	660x180x660
<b>Uni.</b>	1	1.40	1.45	0.012	640x640x30

**10.428**      **620x1260mm**

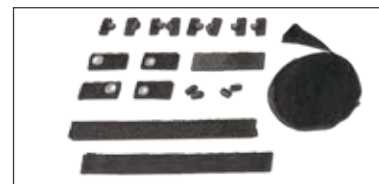
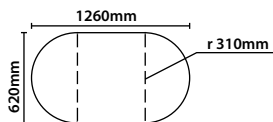

## Golf Banner Cardiff



Outdoor fabric A-frame.

**Material:** Fiberglass.

	QTY	N.W (kg)	G.W (kg)	C.B.M.	Size(mm)
<b>Packing</b>	1	0.52	1.59	0.15	730x300x730

**10.653**      **Ø 700mm**



## Golf Banner Tychy



Outdoor fabric.

**Material:** Fiberglass.

	QTY	N.W (kg)	G.W (kg)	C.B.M.	Size(mm)
<b>Packing</b>	1	1	2.07	0.15	730x300x730

**10.654**      **2500x750mm**

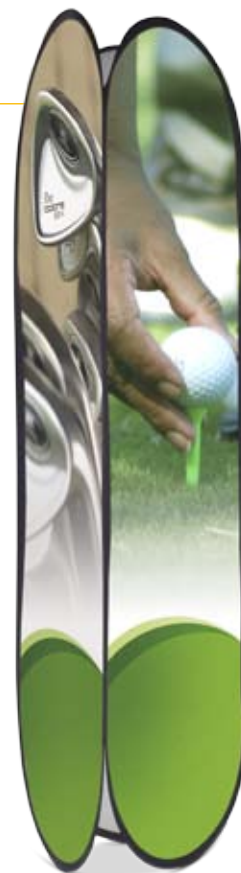

# BARRIER BANNER - OUTDOOR BANNER

1

## Barrier Banner



Consists of aluminium frame, loops, hooks for fixing the digitally printed banner and tent pegs for fixing the frame in soft ground. No tools required for assembly. For indoor and short-term outdoor use. Price includes bag. Size: 2470x955mm.

**Material:** Aluminium.

	QTY	N.W(kg)	G.W(kg)	C.B.M.	Size(mm)
Uni.	1	7	8.1	0.049	200x200x1220

10.548

2410x900mm



## Outdoor Banner Charleroi



1200mm

4 kgs Water

Stable, heavy and durable pavement sign. Suitable to set aside on play grounds, shop entrances and pavement roads. Double face. Water or sand base.

**Material:** Plastic.

	QTY	N.W (kg)	G.W (kg)	C.B.M.	Size(mm)
Packing	1	2	2.5	0.07	500x200x690

10.248

382x330mm



## Outdoor Banner Delta



Double side plastic stand. Outdoor - Indoor use.

**Material:** Plastic.

	QTY	N.W (kg)	G.W (kg)	C.B.M.	Size(mm)
Packing	1	7	8	0.05	1010x630x80

10.679

550x700mm



# OUTDOOR BANNER

## Almazan



X-Banner with large plastic base that can be filled with water.

**Material:** Fiberglass, aluminium.

	QTY	N.W (kg)	G.W (kg)	C.B.M.	Size(mm)
Pole	1	0.55	0.6	0.004	750x80x65
Base	1	0.95	1	0.015	170x250x350

10.028

600X1800mm



## Outdoor Roll Up Haro



Exterior double side banner with plastic base that can be filled with water.

**Material:** Aluminium, plastic.

	QTY	N.W (kg)	G.W (kg)	C.B.M.	Size(mm)
Packing	1	17.7	19.6	0.17	1160x230x620

10.954

800x2000mm



## Almenar



Y-Banner with plastic base that can be filled with water. Adjustable height.

**Material:** Fiberglass, aluminium.

	QTY	N.W (kg)	G.W (kg)	C.B.M.	Size(mm)
Packing	6	13	16.20	0.1	850x400x320
Uni.	1	1.8	2.2	0.02	840x240x100

10.029

800X1900mm



## Lillo



Double sided banner, plastic base that can be filled with water.

**Material:** Aluminium, plastic parts.

	QTY	N.W (kg)	G.W (kg)	C.B.M.	Size(mm)
Packing	1	14.2	25	0.12	920x670x200

10.768

850x2500mm



# OUTDOOR BANNER

1

## Medinaceli



Banner with plastic base that can be filled with water.

**Material:** Steel, plastic parts.

	QTY	N.W (kg)	G.W (kg)	C.B.M.	Size(mm)
Packing	2	7	8.6	0.11	190x540x1050
Uni.	1	2.85	3.50	0.05	1030x500x100

10.026

450x1600mm



## Cepeda

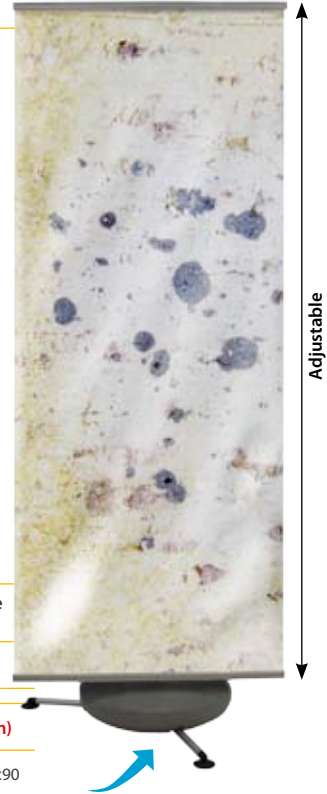

Exterior banner with plastic base that can be filled with water. Adjustable in height.

**Material:** Steel, plastic parts.

	QTY	N.W (kg)	G.W (kg)	C.B.M.	Size(mm)
Pole	1	1.5	1.7	0.01	1160x100x90
Base	1	2	2.25	0.05	460x470x240

10.800

800x1800-2300



## Kiel

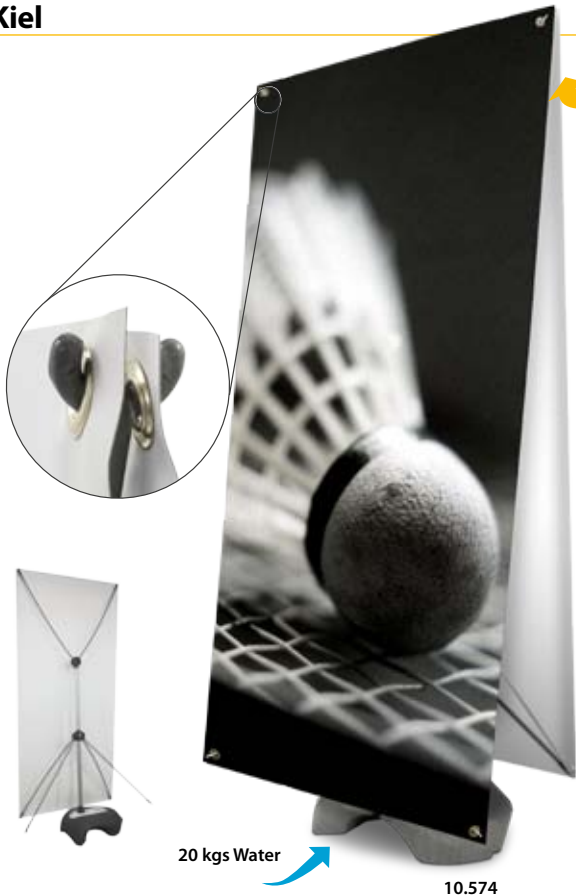

Double sided

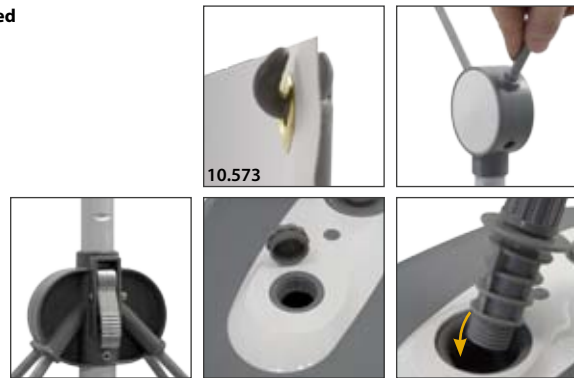

Single or double sided water filled Banner. Telescopic aluminium support pole and adjustable central hub allows for adjustment of height. Graphic area recommended: 900x1750mm.

**Material:** Aluminium, plastic parts.

	QTY	N.W(kg)	G.W(kg)	C.B.M.	Size(mm)
Uni.	1	2.8	3.25	0.09	1080x400x200

10.573

900x1750mm



	QTY	N.W(kg)	G.W(kg)	C.B.M.	Size(mm)
Uni.	1	3	3.45	0.09	1080x400x200

10.574

900x1750mm



## Yuste

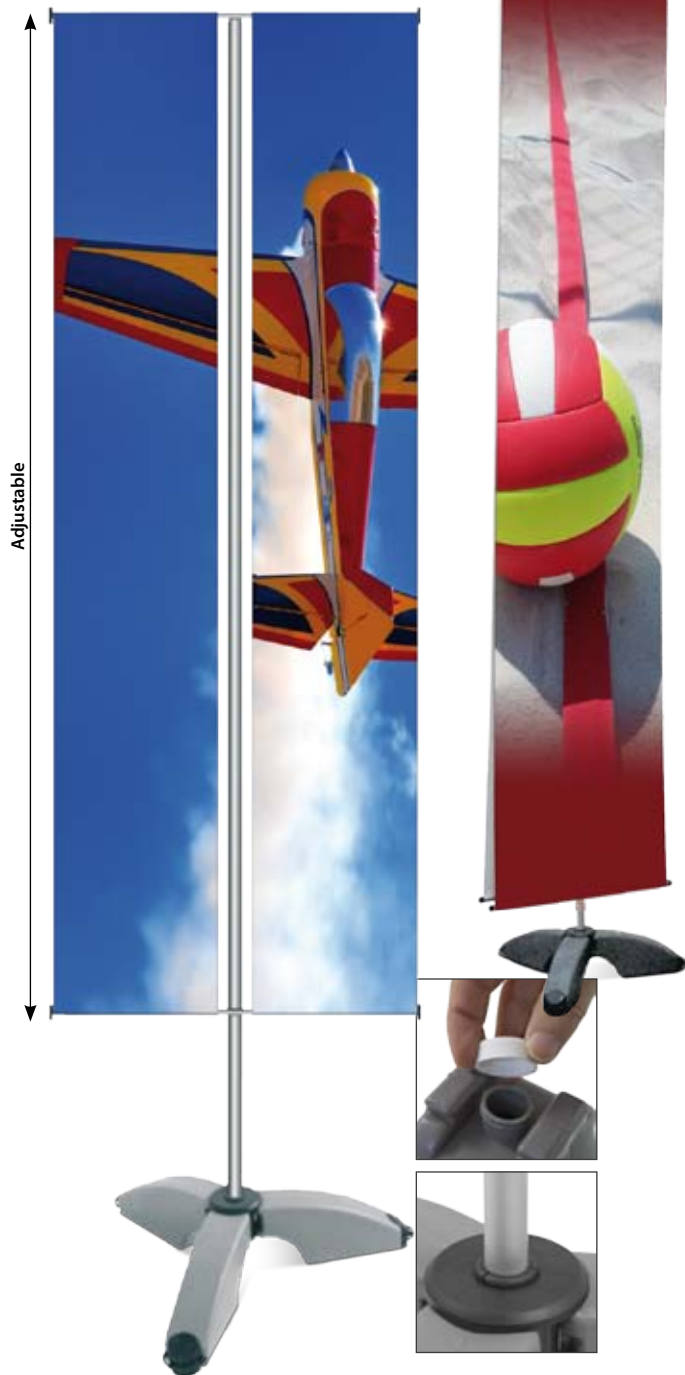

Outdoor flagpole. Can be used with two graphic. Water filled stand.

**Material:** Aluminium, plastic parts.

	QTY	N.W(kg)	G.W(kg)	C.B.M.	Size(mm)
Pole	1	1.35	1.85	0.015	1650x120x80
Base	1	0.95	1.15	0.017	200x340x260

**10.709**      **600x1500-4500**



## Bierzo



Outdoor flagpole. Water filled stand. Adjustable size. Maximum graphic size: 700x2500mm.

**Material:** Steel, plastic parts.

	QTY	N.W (kg)	G.W (kg)	C.B.M.	Size(mm)
Pole	1	0.7	0.7	0.001	1610x25x25
Base	1	1.05	1.45	0.027	350x350x220

**10.027**      **300x2000mm x2**



## Magaz



Giant triple side flagpole 5 meter high. Delivery with a heavy plastic foot which can be filled with 76 liter sand or water.

**Material:** Aluminium, plastic parts.

	QTY	N.W (kg)	G.W (kg)	C.B.M.	Size(mm)
Pole	1	6.45	8.15	0.04	1720x210x120
Base	1	5.8	7.9	0.15	800x440x430

**10.740**      **1000/500x4000mm x3**



# OUTDOOR BANNER

1

## Brest



50 kgs Water



Giant flagpole 4,1 meters high. Delivery with a heavy plast foot wich can be filled with 50kg. sand or water.

**Material:** Aluminium, plastic parts.

	QTY	N.W(kg)	G.W(kg)	C.B.M.	Size(mm)
<b>Pole</b>	4	5.5	22	0.137	1630x295x295
<b>Base</b>	1	6	6.3	0.088	665x265x665

**10.652**      **800x2800mm**



## Cergy



10.577

76 kgs Water

10.578

134 kgs Water

Giant flagpole 7 or 9 meters high. Delivery with a heavy plast foot wich can be filled with sand or water.

Ref.: 10.577 graphic size: ± 1200x6000mm.

Ref.: 10.578 graphic size: ± 1200x7500mm.

**Material:** Aluminium, plastic parts.

	QTY	N.W (kg)	G.W (kg)	C.B.M.	Size(mm)
<b>Pole</b>	1	6.5	7.5	0.03	1710x150x130
<b>Base</b>	1	8	9	0.13	805x410x410

**10.577**      **1200x6000mm**



	QTY	N.W (kg)	G.W (kg)	C.B.M.	Size(mm)
<b>Pole</b>	1	8.5	9.5	0.05	1710x180x170
<b>Base</b>	1	14	15	0.24	920x510x510

**10.578**      **1200x7500mm**



## Bejar



Giant Flagpole 5 meter high. Delivery wity a heavy plast foot wich can be filled with 76 liter sand or water. 10828: includes plastics clips for bottom graphics.  
Graphic size: 1100x3500mm.

**Material:** Aluminium, plastic parts.

	QTY	N.W(kg)	G.W(kg)	C.B.M.	Size(mm)
Pole	1	7.5	9.8	0.04	130x160x1680
Base	1	10	11	0.14	380x430x850

10.031 1100x3500mm



# OUTDOOR BANNER

1

## Molar

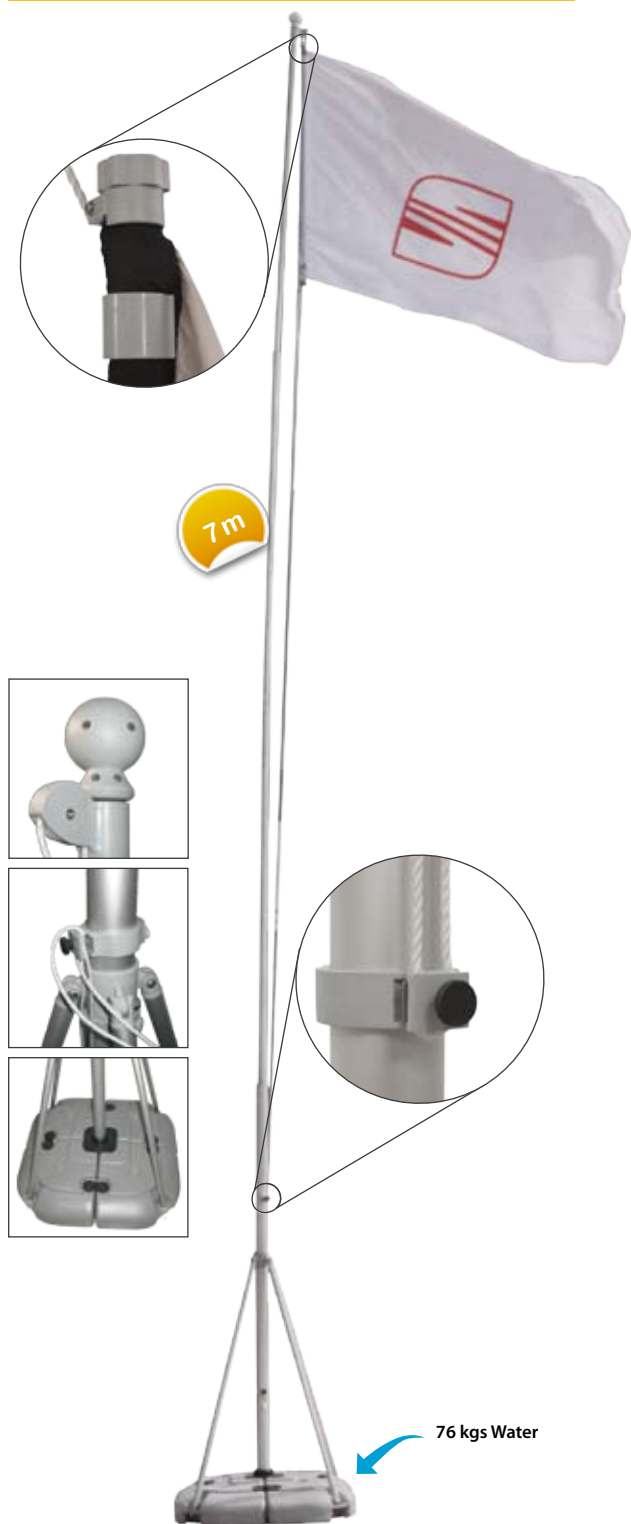

Giant flagpole 7 meter high. Delivery with a heavy plast foot wich can be filled with 76 liter sand o water. Graphic size: adjustable.

**Material:** Aluminium, plastic parts.

	QTY	N.W(kg)	G.W(kg)	C.B.M.	Size(mm)
Pole	1	5	6.5	0.055	210x120x2170
Base	1	10	12	0.15	860x420x410

10.743

7000mm



## Lamp System

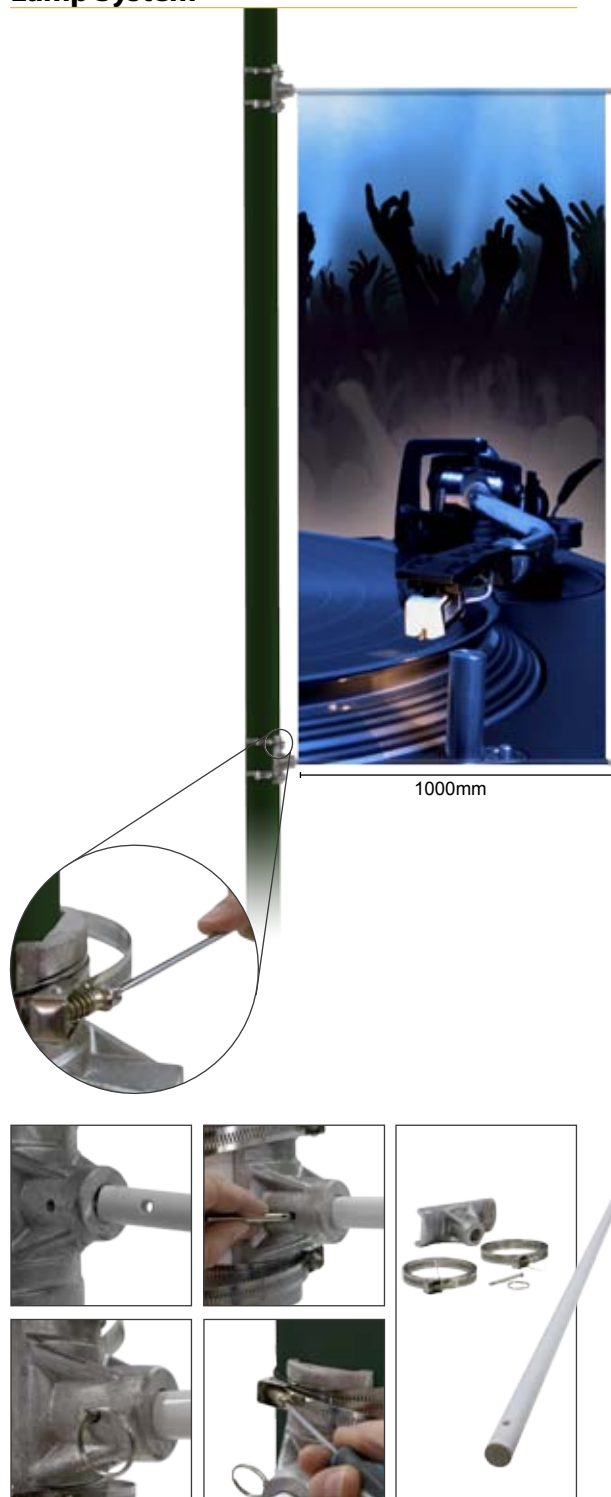

Banner flag system for lamp or another outdoor post. This support is designed for stronger wind conditions. Each kit includes:

- 1 aluminium bracket.
- 1 pin and 1 ring.
- 2 stainless steel band.
- 1 fiberglass pole 1000mm. length.

**Material:** Aluminium, plastic parts.

	QTY	N.W(kg)	G.W(kg)	C.B.M.	Size(mm)
Uni.	1	1	1.35	0.006	1010x100x65

12.353



# OUTDOOR BANNER

## Barahona - 1



A-Banner outdoor stand systems with water/sand fillable base offering impressive single or double sided graphic displays. Graphic size: 2500x2000mm.

**Material:** Aluminium, plastic parts.

	QTY	N.W(kg)	G.W(kg)	C.B.M.	Size(mm)
Pole	1	11.5	16	0.04	1660x210x410
Base	1	8	9	0.11	850x310x430

**10.030 3000x2000/2500mm**



## Barahona - 2

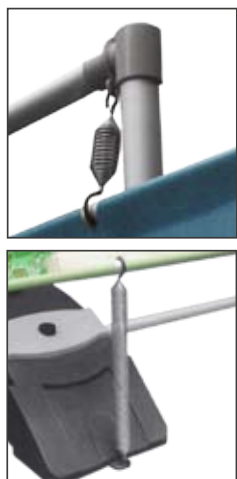

Double sided

25 kgs Water



A-Banner giant outdoor stand systems with water/sand fillable base offering impressive single or double sided graphic displays.

**Material:** Aluminium, plastic parts.

	QTY	N.W(kg)	G.W(kg)	C.B.M.	Size(mm)
Pole	1	17.2	21.1	0.044	1720x150x170
Base	1	13.30	18.3	0.12	850x300x470

**10.830 5640x2450mm**

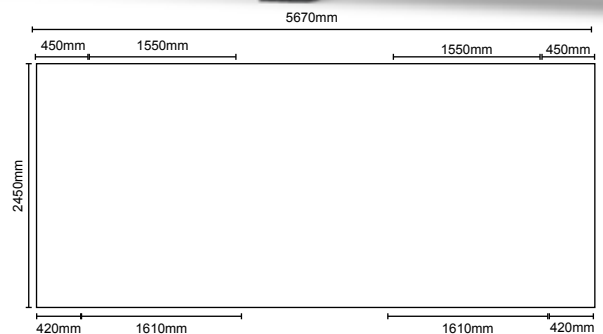

# FLYING BANNER

1

## Flying Banner Paramo



Flying banner with heavy foot in crone as well as plast bag, wich can be filled with sand or water.

**Material:** Aluminium, fiberglass.

	QTY	N.W(kg)	G.W(kg)	C.B.M.	Size(mm)
<b>Pole</b>	1	0.75	0.9	0.005	1320x70x60
<b>Base</b>	1	0.6	0.7	0.007	460x120x120

**10.752 ± 3600mm**



	QTY	N.W(kg)	G.W(kg)	C.B.M.	Size(mm)
<b>Pole</b>	1	1.05	1.25	0.06	1400x110x40
<b>Base</b>	1	0.6	0.7	0.007	460x120x120

**10.753 ± 5000mm**



	QTY	N.W(kg)	G.W(kg)	C.B.M.	Size(mm)
<b>Pole</b>	1	1.2	1.4	0.004	1400x90x30
<b>Base</b>	1	0.6	0.7	0.007	460x120x120

**10.754 ± 6000mm**



	QTY	N.W(kg)	G.W(kg)	C.B.M.	Size(mm)
<b>Packing</b>	20	3	4	0.006	200x200x150
<b>Uni.</b>	1	0.15	0.2	0.009	140x160x40



**10.766 Water plast bag**

## Flying Banner Torio



Flying Banner with plastic ground spike.

**Material:** Aluminium, fiberglass.

	QTY	N.W(kg)	G.W(kg)	C.B.M.	Size(mm)
<b>Pole</b>	1	0.75	0.9	0.005	1320x70x60
<b>Base</b>	1	0.65	0.8	0.013	570x150x150

**10.755 ± 3600mm**



	QTY	N.W(kg)	G.W(kg)	C.B.M.	Size(mm)
<b>Pole</b>	1	1.05	1.25	0.06	1400x110x40
<b>Base</b>	1	0.65	0.8	0.013	570x150x150

**10.756 ± 5000mm**



	QTY	N.W(kg)	G.W(kg)	C.B.M.	Size(mm)
<b>Pole</b>	1	1.2	1.4	0.004	1400x90x30
<b>Base</b>	1	0.65	0.8	0.013	570x150x150

**10.757 ± 6000mm**



	QTY	N.W(kg)	G.W(kg)	C.B.M.	Size(mm)
<b>Packing</b>	20	30	31	0.13	600x400x540
<b>Uni.</b>	1	1.5	1.55	0.013	580x330x70



**10.092 Mount for use under car**

## Encinas



Flying banner with heavy duty folding universal cross base.

**Material:** Aluminium, fibreglas, plastic parts.

	QTY	N.W(kg)	G.W(kg)	C.B.M.	Size(mm)
Uni.	1	3.15	3.85	0.01	1000x170x70
<b>10.399</b>		Ⓢ ± 2550mm			
	QTY	N.W(kg)	G.W(kg)	C.B.M.	Size(mm)
Uni.	1	3.7	4.3	0.02	1200x200x80
<b>10.033</b>		Ⓜ ± 3420mm			
	QTY	N.W(kg)	G.W(kg)	C.B.M.	Size(mm)
Uni.	1	4.55	5.15	0.018	1200x170x90
<b>10.746</b>		Ⓛ ± 4530mm			

## Guijuelo



Flying banner with ground spike.

**Material:** Aluminium, fibreglas, plastic parts.

	QTY	N.W(kg)	G.W(kg)	C.B.M.	Size(mm)
Uni.	1	1.45	2.25	0.012	1030x170x70
<b>10.745</b>		Ⓢ ± 2550mm			
	QTY	N.W(kg)	G.W(kg)	C.B.M.	Size(mm)
Uni.	1	1.55	2.5	0.02	1200x200x80
<b>10.744</b>		Ⓜ ± 3420mm			
	QTY	N.W(kg)	G.W(kg)	C.B.M.	Size(mm)
Uni.	1	1.95	3	0.018	1200x170x90
<b>10.032</b>		Ⓛ ± 4530mm			

# FLYING BANNER

1

## Narbonna



Flying banner with a black plast foot wich can be filled with sand or water.

**Material:** Aluminium, fiberglas, plastic parts.

	QTY	N.W(kg)	G.W(kg)	C.B.M.	Size(mm)
<b>Pole</b>	20	7.8	13.33	0.108	1430x270x280
<b>Base</b>	8	8	10	0.213	750x380x750

**10.651 ± 1600x600mm**



## Amiens

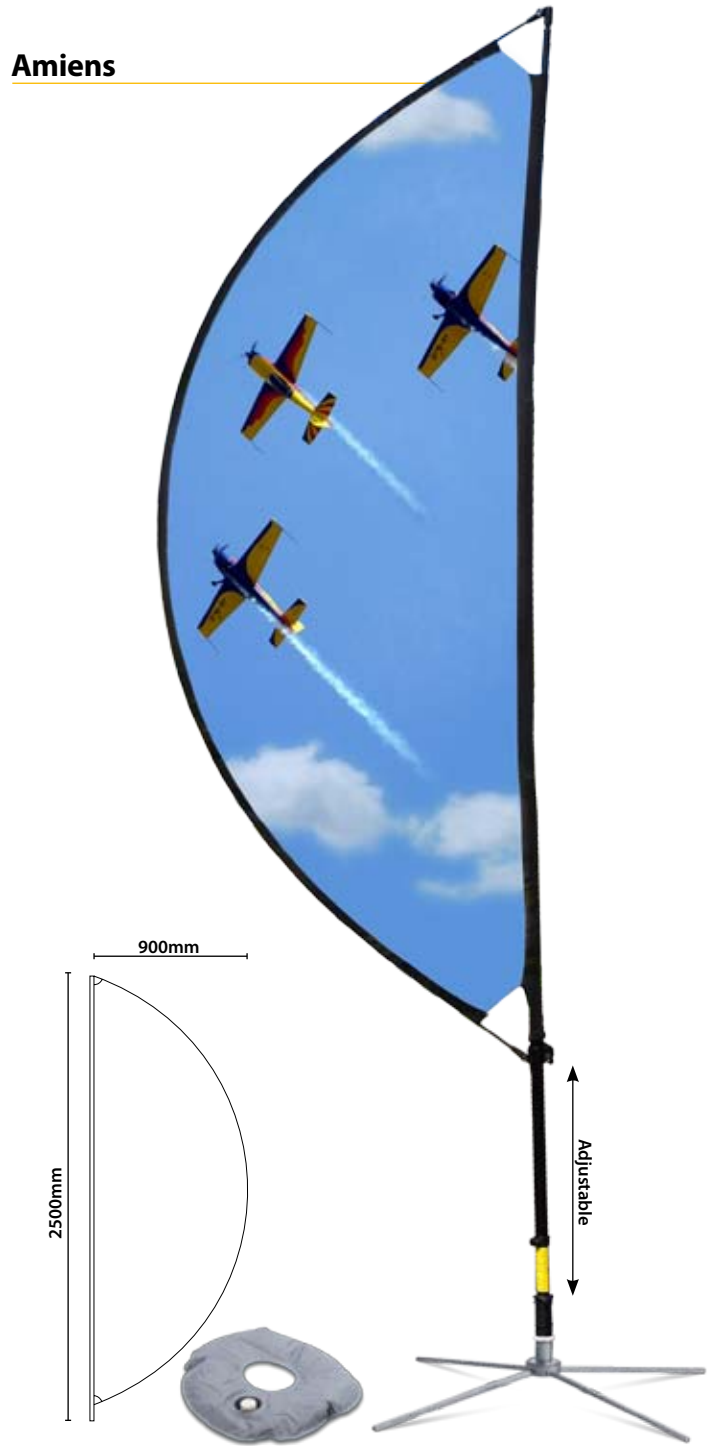

Water plast bag includes



Flying banner with heavy foot in chrome as well as plast bag, wich can be filled with sand or water.

**Material:** Aluminium, fiberglas, plastic parts.

	QTY	N.W(kg)	G.W(kg)	C.B.M.	Size(mm)
<b>Packing</b>	20	32.2	35	0.146	1430x270x380

**10.650 ± 2500x900mm**



# BEACH BANNER

## Beach Banner Landas



Flying Banner with plastic ground spike.

**Material:** Aluminium.

	QTY	N.W(kg)	G.W(kg)	C.B.M.	Size(mm)
<b>Pole</b>	1	0.8	1	0.012	1050x120x100
<b>Base</b>	1	0.65	0.8	0.013	570x150x150
<b>10.735</b>	<b>± 3000mm</b>		<b>810x2300mm</b>		

	QTY	N.W(kg)	G.W(kg)	C.B.M.	Size(mm)
<b>Pole</b>	1	1.25	1.45	0.012	1050x120x100
<b>Base</b>	1	0.65	0.8	0.013	570x150x150
<b>10.736</b>	<b>± 4000mm</b>		<b>810x3300mm</b>		

	QTY	N.W(kg)	G.W(kg)	C.B.M.	Size(mm)
<b>Pole</b>	1	1.4	1.65	0.008	1390x100x60
<b>Base</b>	1	0.65	0.8	0.013	570x150x150
<b>10.737</b>	<b>± 5000mm</b>		<b>810x4050mm</b>		

\*Printing

## Beach Banner Orthez



Flying banner with heavy foot in chrome.

**Material:** Aluminium.

	QTY	N.W(kg)	G.W(kg)	C.B.M.	Size(mm)
<b>Pole</b>	1	0.8	1	0.012	1050x120x100
<b>Base</b>	1	0.75	0.85	0.009	580x150x100
<b>10.502</b>	<b>± 3000mm</b>		<b>810x2300mm</b>		

	QTY	N.W(kg)	G.W(kg)	C.B.M.	Size(mm)
<b>Pole</b>	1	1.25	1.45	0.012	1050x120x100
<b>Base</b>	1	0.75	0.85	0.009	580x150x100
<b>10.503</b>	<b>± 4000mm</b>		<b>810x3300mm</b>		

	QTY	N.W(kg)	G.W(kg)	C.B.M.	Size(mm)
<b>Pole</b>	1	1.4	1.65	0.008	1390x100x60
<b>Base</b>	1	0.75	0.85	0.009	580x150x100
<b>10.504</b>	<b>± 5000mm</b>		<b>810x4050mm</b>		

\*Printing

	QTY	N.W(kg)	G.W(kg)	C.B.M.	Size(mm)
<b>Packing</b>	20	3	4	0.006	200x200x150
<b>Uni.</b>	1	0.15	0.2	0.009	140x160x40



**10.766 Water plast bag**

1

## Gabin



Graphic system setting through heavy suction cup. Ideal for graphic 3mm to 10mm thick. Necessary the drilling of the graphics for fixing screws through the cup.

**Material:** Plastic.

	QTY	N.W (kg)	G.W (kg)	C.B.M.	Size(mm)
Packing	1	0.25	0.3	0.001	125x125x125

**10.595**

**Ø 120mm**

## Cano

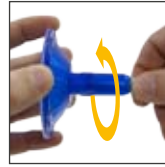

Window flag-banner. Packaging: 5 units.

**Material:** Plastic.

	QTY	N.W (kg)	G.W (kg)	C.B.M.	Size(mm)
Packing	5	0.5	0.55	0.002	640x170x20

**10.797**

**500x900mm**

## Vargas

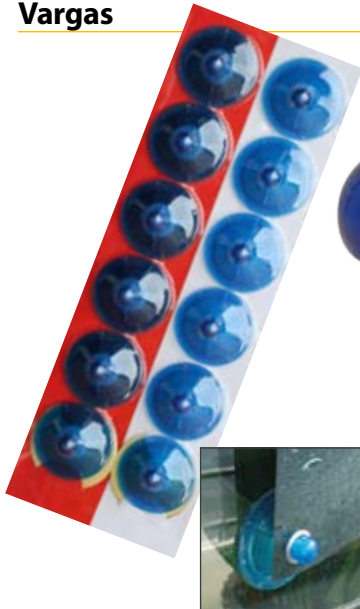

Ø72mm

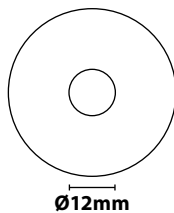

Ø12mm

Heavy suction cup for windows.

**Material:** Plastic.

	QTY	N.W (kg)	G.W (kg)	C.B.M.	Size(mm)
Packing	12	0.4	0.45	0.04	580x170x40

**10.798**

**Pack 12 Uni.**

## Viso



Ø65mm

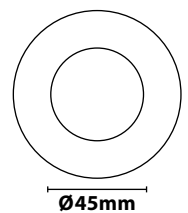

Ø45mm

Suction cup with adhesive.

**Material:** Aluminium, plastic parts.

	QTY	N.W (kg)	G.W (kg)	C.B.M.	Size(mm)
Packing	4	0.09	0.15	0.0008	120x80x80

**10.779**

**Pack 4 Uni.**

## Pop-Up Fashion Cumbre



Pop-Up Fashion "triangle" with stretch-prints gives a 3-D effect. New printing technology for fabric. Ideal for promotion in the point of sale and events.

**Material:** Aluminium.

	QTY	N.W (kg)	G.W (kg)	C.B.M.	Size(mm)
Packing	1	6.2	7.7	0.05	240x240x840

**10.423**      **3215x2040x350mm**



## Pop-Up Fashion Mora



Pop-Up Fashion "straight" with stretch-prints gives a 3-D effect. New printing technology for fabric. Ideal for promotion in the point of sale and events.

**Material:** Aluminium.

	QTY	N.W (kg)	G.W (kg)	C.B.M.	Size(mm)
Packing	1	8.1	10	0.03	190x190x830

**10.422**      **2215x2215x350mm**



## Pop-Up Fashion Alia



Pop-Up Fashion "column" with stretch-prints gives a 3-D effect. New printing technology for fabric. Ideal for promotion in the point of sale and events.

**Material:** Aluminium.

	QTY	N.W (kg)	G.W (kg)	C.B.M.	Size(mm)
Packing	1	5	6.5	0.03	190x190x830

**10.424**      **2215x770x350mm**



## Totem Pop-Up Villoria



Pop-up exhibition stand Tower.  
Display size: 600x2300mm.  
Graphic size: 637x2300mm x3 panels.

**Material:** Aluminium.

	QTY	N.W (kg)	G.W (kg)	C.B.M.	Size(mm)
Packing	1	9	12	0.08	350x250x850

**10.040**      **637x2300mm**



# VELCRO POP-UP

1

## Pop-Up Cangas 3x3 - 4x3

Economical Velcro Pop-Up are portable exhibition graphic banner display systems with a "pop-up" collapsible/retractable aluminium frame. Locked by spring system. Includes:

- Trolley carry bag.
- Velcro.
- 2 spot light.

**Material:** Aluminium.

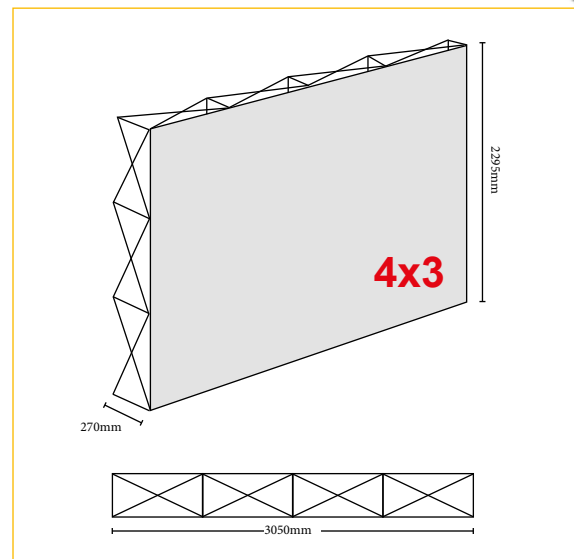
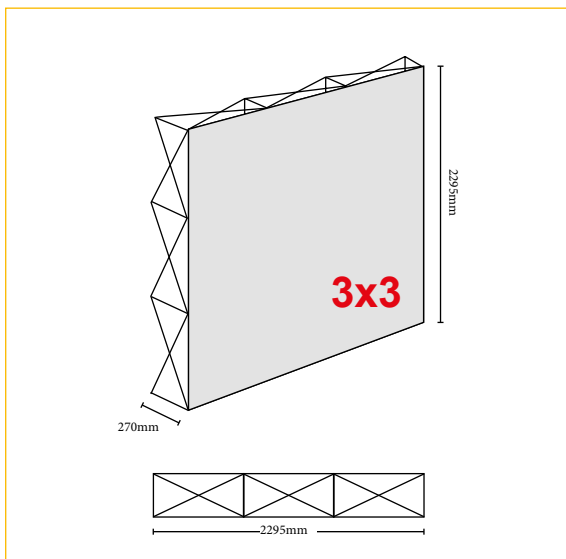

	QTY	N.W(kg)	G.W(kg)	C.B.M.	Size(mm)
<b>Packing</b>	1	13.20	15	0.2	450x450x950

	QTY	N.W(kg)	G.W(kg)	C.B.M.	Size(mm)
<b>Packing</b>	1	16.35	17.95	0.2	450x450x950

**10.413**      **3x3**    **2295x2295mm**     

**10.414**      **4x3**    **3050x2295mm**     



## Pop-Up Cangas 5x3 - 6x3 - 7x3

Economical Velcro Pop-Up are portable exhibition graphic banner display systems with a "pop-up" collapsible/retractable aluminium frame. Locked by spring system. Includes:

- Trolley carry bag.
- Velcro.
- 2 spot light.

**Material:** Aluminium.

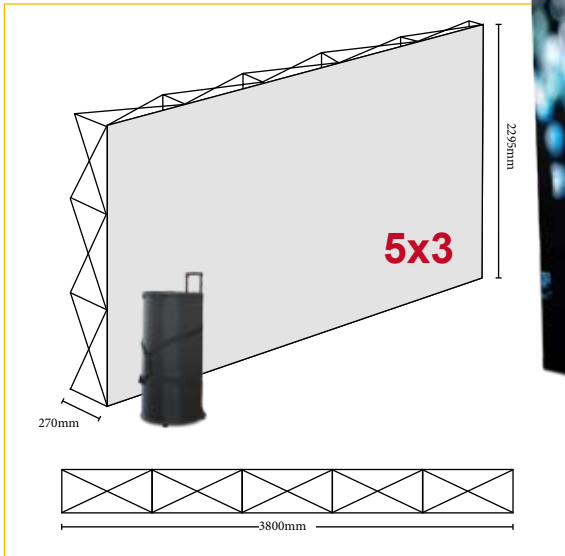

	QTY	N.W(kg)	G.W(kg)	C.B.M.	Size(mm)
Packing	1	16.95	18.30	0.201	460x460x950

**10.938 5x3 3800x2295mm**

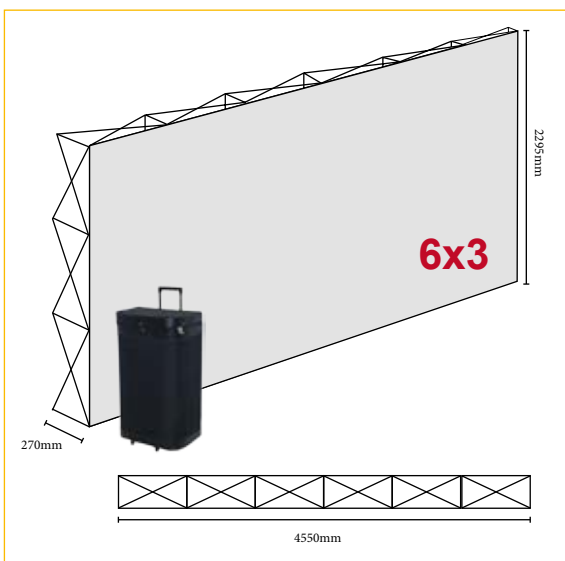

	QTY	N.W(kg)	G.W(kg)	C.B.M.	Size(mm)
Packing	1	20.50	21.90	0.200	540x400x950

**10.939 6x3 4550x2295mm**

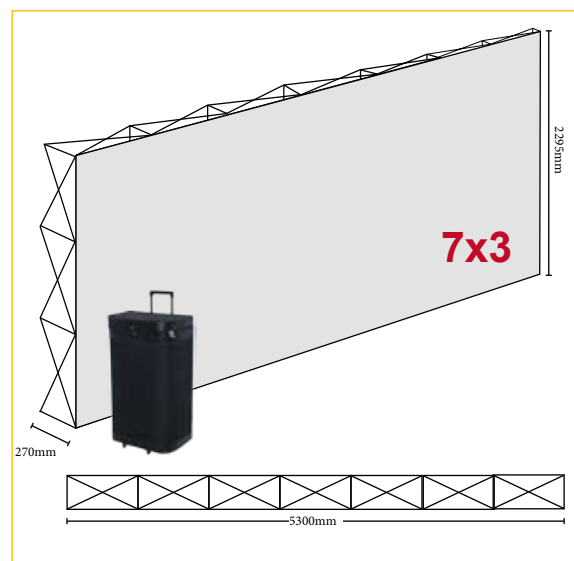

	QTY	N.W(kg)	G.W(kg)	C.B.M.	Size(mm)
Packing	1	22.65	24.50	0.201	540x400x950

**10.951 7x3 5300x2295mm**



## 1 Pop-Up Arevalo 2x3 Vertical

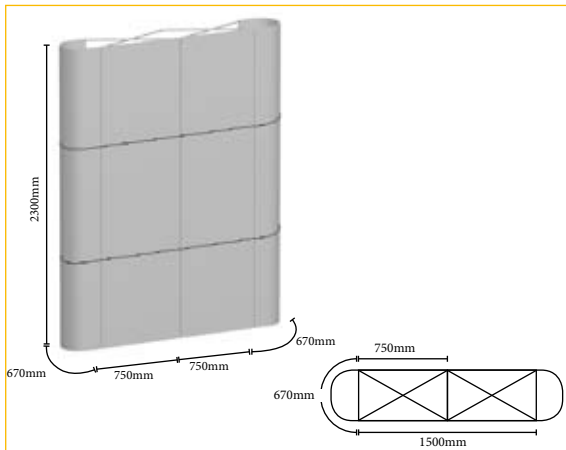

Flexible pop-up straight vertical wall system is made a foldable tube construction. The framework is made of aluminium. The construction makes it easy and fast to assemble the panels with graphics. Includes:

- Hard trolley carry bag.
- Magnetic strip roll.
- Hangers / Magnetic bars.
- 2 spot light.

**Material:** Aluminium.

	QTY	N.W(kg)	G.W(kg)	C.B.M.	Size(mm)
<b>Packing</b>	1	29.4	32.6	0.32	730x430x1010

**10.369**      **670x2300mm x2**  
**750x2300mm x2**



## Pop-Up Arevalo 3x2 Horizontal

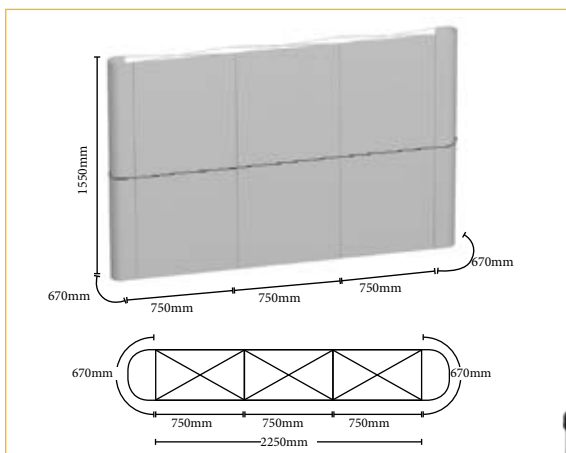

Flexible pop-up straight horizontal wall system is made a foldable tube construction. The framework is made of aluminium. The construction makes it easy and fast to assemble the panels with graphics. Includes:

- Hard trolley carry bag.
- Magnetic strip roll.
- Hangers / Magnetic bars.
- 2 spot light.

**Material:** Aluminium.

	QTY	N.W(kg)	G.W(kg)	C.B.M.	Size(mm)
<b>Packing</b>	1	28.8	32	0.32	720x430x1010

**10.425**      **670x1550mm x2**  
**750x1550mm x3**



## Pop-Up Laredo 3x3

Flexible pop-up curved or straight wall system is made a foldable tube construction. The framework is made of aluminium. The construction makes it easy and fast to assemble the panels with graphics. Includes:

- Trolley carry bag.
- Hangers / Magnetic bars.
- Magnetic strip roll.
- 2 spot light.

**Material:** Aluminium.

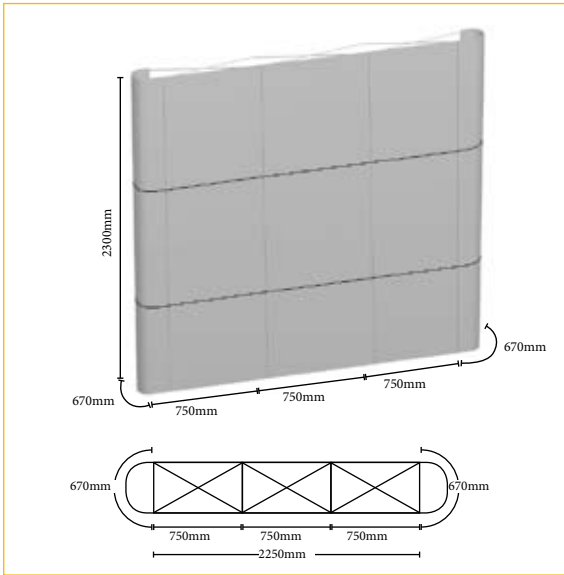

	QTY	N.W(kg)	G.W(kg)	C.B.M.	Size(mm)
<b>Packing</b>	1	17.15	18.6	0.12	390x340x920
<b>10.520</b>	<b>670x2300mm x2</b>				
	<b>750x2300mm x3</b>				

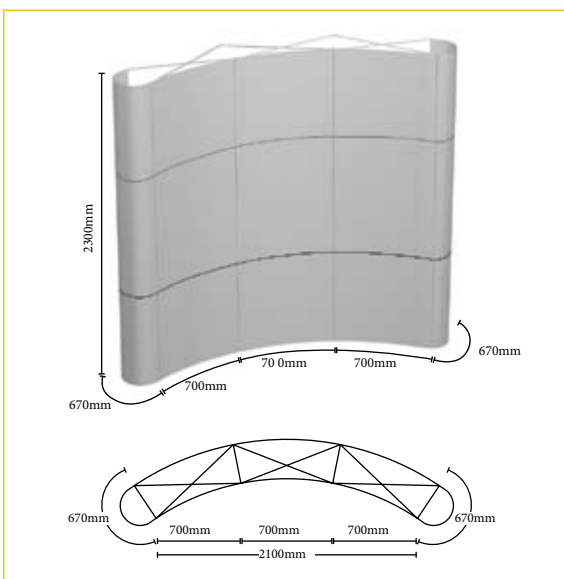

	QTY	N.W(kg)	G.W(kg)	C.B.M.	Size(mm)
<b>Packing</b>	1	17.15	18.6	0.12	390x340x920
<b>10.547</b>	<b>670x2300mm x2</b>				
	<b>700x2300mm x3</b>				



## 1 Pop-Up Gredos 3x3 Straight

Flexible pop-up straight wall system is made a foldable tube construction. The framework is made of aluminium. The construction makes it easy and fast to assemble the panels with graphics. Includes:

- Hard trolley carry bag.
- Magnetic strip roll.
- Hangers / Magnetic bars.
- 2 spot light.

**Material:** Aluminium.

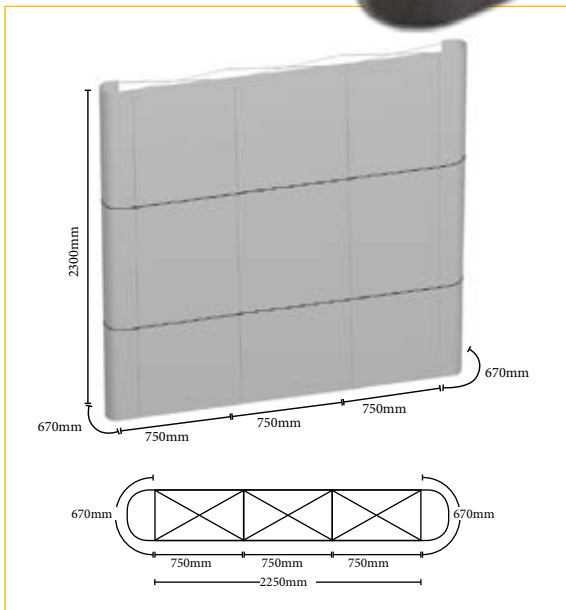

	QTY	N.W(kg)	G.W(kg)	C.B.M.	Size(mm)
<b>Packing</b>	1	32.25	35.45	0.32	730x430x1010

**10.366** 670x2300mm x2  
750x2300mm x3

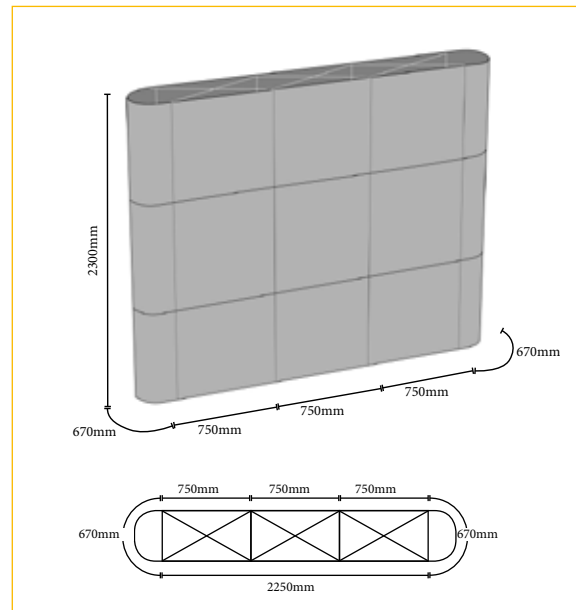

	QTY	N.W(kg)	G.W(kg)	C.B.M.	Size(mm)
<b>Packing</b>	1	34.75	37.95	0.32	730x430x1010

**10.397** 670x2300mm x2  
750x2300mm x6



## Pop-Up Gredos 3x3 Curved

Flexible pop-up curved wall system is made a foldable tube construction. The framework is made of aluminium. The construction makes it easy and fast to assemble the panels with graphics. Includes:

- Hard trolley carry bag.
- Magnetic strip roll.
- Hangers / Magnetic bars.
- 2 spot light.

**Material:** Aluminium.

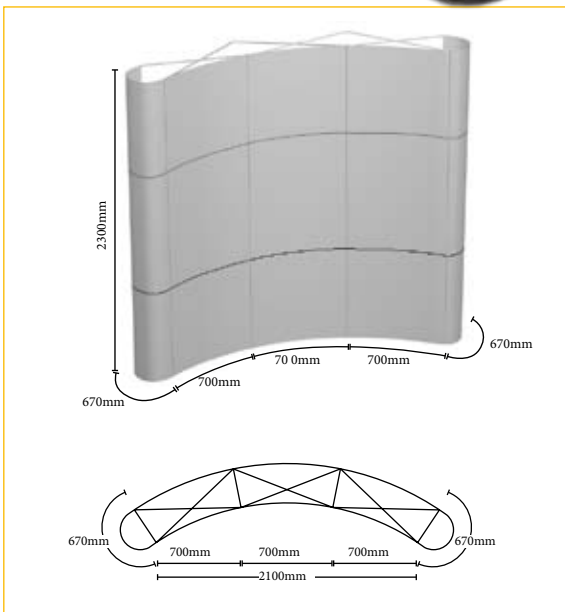

	QTY	N.W(kg)	G.W(kg)	C.B.M.	Size(mm)
<b>Packing</b>	1	32.25	35.45	0.32	730x430x1010
<b>10.367</b>	<b>670x2300mm x2</b>		<b>700x2300mm x3</b>		

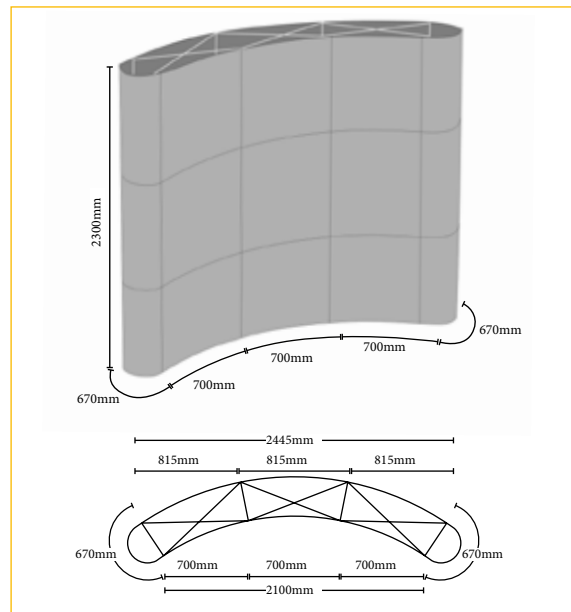

	QTY	N.W(kg)	G.W(kg)	C.B.M.	Size(mm)
<b>Packing</b>	1	34.75	37.95	0.32	730x430x1010
<b>10.398</b>	<b>670x2300mm x2</b>		<b>700x2300mm x3</b>		<b>815x2300mm x3</b>



## 1 Pop-Up Madrigal 4x3 Straight

Flexible pop-up straight wall system is made a foldable tube construction. The framework is made of aluminium. The construction makes it easy and fast to assemble the panels with graphics. Includes:

- Hard trolley carry bag.
- Magnetic strip roll.
- Hangers / Magnetic bars.
- 2 spot light.

**Material:** Aluminium.

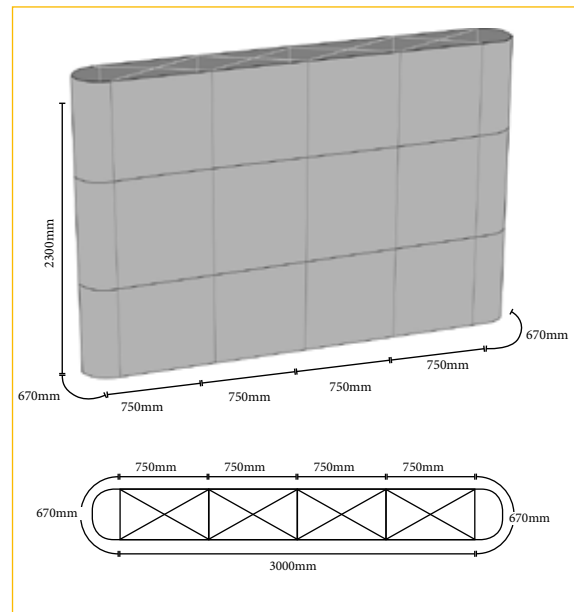
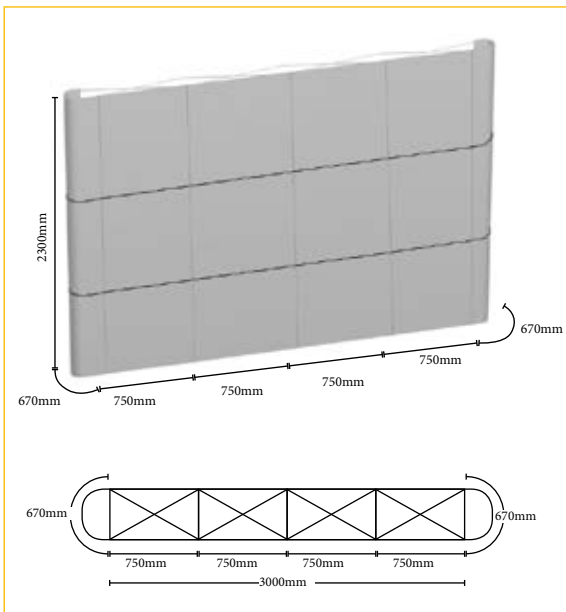

	QTY	N.W(kg)	G.W(kg)	C.B.M.	Size(mm)
<b>Packing</b>	1	36.3	39.5	0.3	710x430x1000
<b>10.036</b>	<b>670x2300mm x2</b>				
	<b>750x2300mm x4</b>				



	QTY	N.W(kg)	G.W(kg)	C.B.M.	Size(mm)
<b>Packing</b>	1	44.5	47.7	0.30	730x430x1000
<b>10.857</b>	<b>670x2300mm x2</b>				
	<b>750x2300mm x8</b>				



## Pop-Up Madrigal 4x3 Curved

Flexible pop-up curved wall system is made a foldable tube construction. The framework is made of aluminium. The construction makes it easy and fast to assemble the panels with graphics. Includes:

- Hard trolley carry bag.
- Magnetic strip roll.
- Hangers / Magnetic bars.
- 2 spot light.

**Material:** Aluminium.

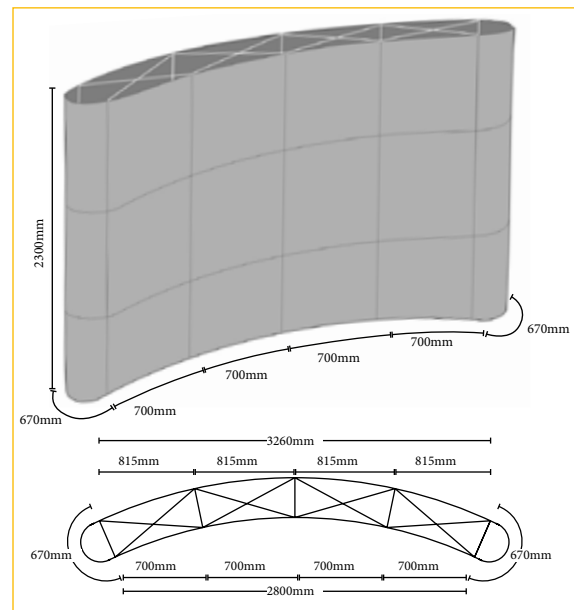
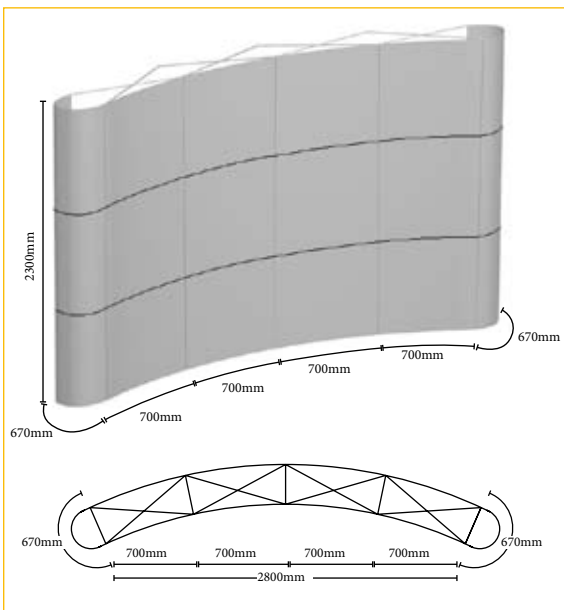

	QTY	N.W(kg)	G.W(kg)	C.B.M.	Size(mm)
<b>Packing</b>	1	36.3	39.5	0.3	710x430x1000
<b>10.037</b>	<b>670x2300mm x2</b>				
	<b>700x2300mm x4</b>				



	QTY	N.W(kg)	G.W(kg)	C.B.M.	Size(mm)
<b>Packing</b>	1	44.5	47.7	0.3	710x430x1000
<b>10.400</b>	<b>670x2300mm x2</b>				
	<b>700x2300mm x4</b>				
	<b>815x2300mm x4</b>				



## Pop-Up Llanes 4x3

Flexible pop-up curved or straight wall system is made a foldable tube construction. The framework is made of aluminium. The construction makes it easy and fast to assemble the panels with graphics. Includes:

- Trolley carry bag.
- Magnetic strip roll.
- Hangers / Magnetic bars.
- 2 spot light.

**Material:** Aluminium.

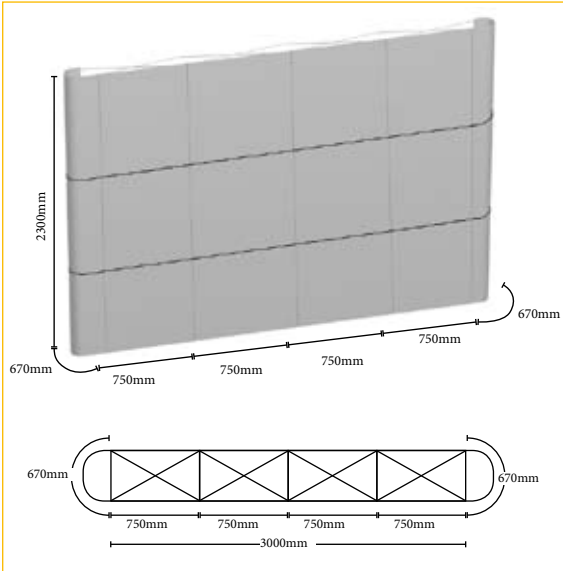

	QTY	N.W(kg)	G.W(kg)	C.B.M.	Size(mm)
<b>Packing</b>	1	21.7	22.1	0.12	390x340x920
<b>10.513</b>	<b>670x2300mm x2</b>				
	<b>750x2300mm x4</b>				

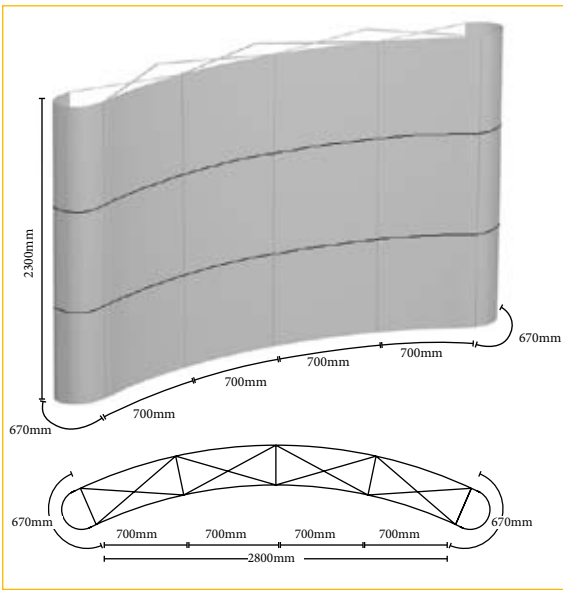

	QTY	N.W(kg)	G.W(kg)	C.B.M.	Size(mm)
<b>Packing</b>	1	21.7	22.1	0.12	390x340x920
<b>10.519</b>	<b>670x2300mm x2</b>				
	<b>700x2300mm x4</b>				





## Pop-Up Nazaré 5x3

Ref.10.236

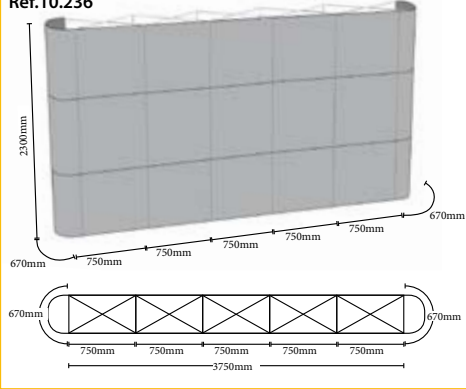

Ref.10.238

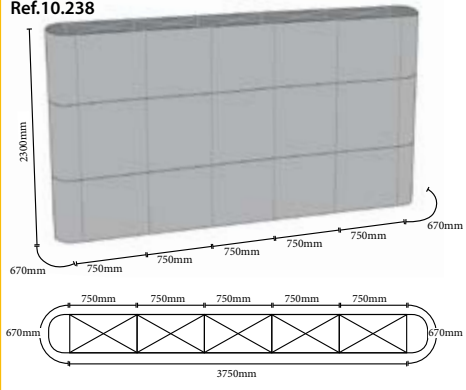

Ref.10.237

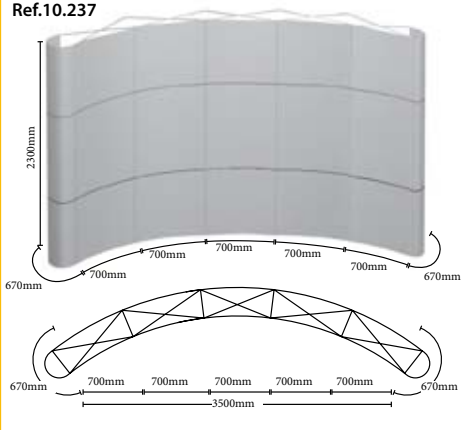

Ref.10.239

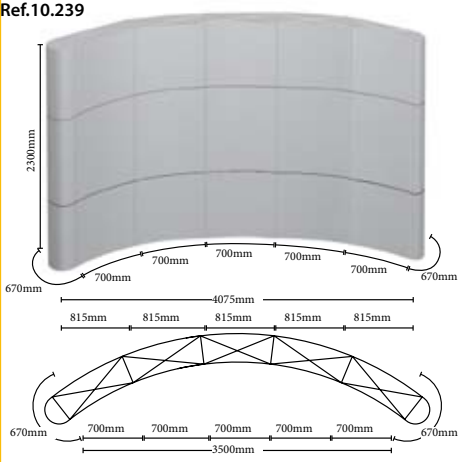

Flexible pop-up curved or straight wall system is made a foldable tube construction. The framework is made of aluminium. The construction makes it easy and fast to assemble the panels with graphics. Includes:

- Hard trolley carry bag.
- Magnetic strip roll.
- Hangers / Magnetic bars.
- 2 spot light.

**Material:** Aluminium.

	QTY	N.W(kg)	G.W(kg)	C.B.M.	Size(mm)
<b>Packing</b>	1	40.1	43.3	0.32	730x430x1010

**10.236**

**670x2300mm x2  
750x2300mm x5**



	QTY	N.W(kg)	G.W(kg)	C.B.M.	Size(mm)
<b>Packing</b>	1	40.1	43.3	0.32	730x430x1010

**10.238**

**670x2300mm x2  
750x2300mm x10**



	QTY	N.W(kg)	G.W(kg)	C.B.M.	Size(mm)
<b>Packing</b>	1	40.1	43.3	0.32	730x430x1010

**10.237**

**670x2300mm x2  
700x2300mm x5**



	QTY	N.W(kg)	G.W(kg)	C.B.M.	Size(mm)
<b>Packing</b>	1	43.35	48.55	0.32	730x430x1010

**10.239**

**670x2300mm x2  
700x2300mm x5  
815x2300mm x5**



1

## Hard-Case Trolley Maqueda

Hard-Case Trolley with wheels, for easy transportation and storage.  
Graphic size: 1800x750mm.

**Material:** Black PVC.



	QTY	N.W (kg)	G.W (kg)	C.B.M.	Size(mm)
Packing	1	13	15.2	0.3	710x420x1000

**10.058 700x960x400mm**

## Hard-Case Trolley Noves

Hard-Case Trolley medium size with wheels, for easy transportation and storage.  
Graphic size: 1800x750mm.

**Material:** Black PVC.



	QTY	N.W (kg)	G.W (kg)	C.B.M.	Size(mm)
Packing	1	7	9.1	0.18	410x430x1000

**10.059 420x960x380mm**

## Soft-Case Trolley Escalona

Soft-Case Trolley with wheels, for easy transportation and storage.

**Material:** Black Nylon.



	QTY	N.W (kg)	G.W (kg)	C.B.M.	Size(mm)
Packing	1	15	18.6	0.12	1030x680x170

**10.060 430x810mm**

## Plastic Piece For Magnetic Bar

	QTY	N.W (kg)	G.W (kg)	C.B.M.	Size(mm)
Packing	1	0.014	0.015	0.00002	50x50x10

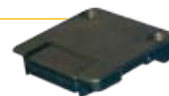

**10.858 50x50x10mm**

## Pop-Up Corner

	QTY	N.W (kg)	G.W (kg)	C.B.M.	Size(mm)
Packing	1	0.038	0.039	0.00007	50x50x30



**10.409 50x50x20**

## Magnetic Bar

Magnetic bar. You can use with the models Madrigal, Gredos, Arevalo, Laredo and Llanes.

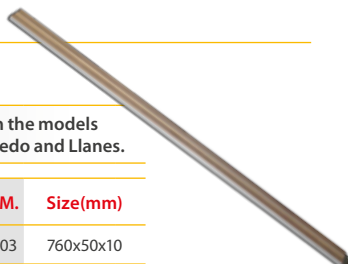

	QTY	N.W (kg)	G.W (kg)	C.B.M.	Size(mm)
Packing	1	0.2	0.22	0.0003	760x50x10

**10.419 720mm**

## Plastic Piece For Bar Graphics

	QTY	N.W (kg)	G.W (kg)	C.B.M.	Size(mm)
Packing	1	0.02	0.021	0.00006	60x50x20



**10.859 60x50x10**

## Top and Bottom Bar Graphic (3x3)

Top and bottom bar graphic for pop up 3x3.

	QTY	N.W (kg)	G.W (kg)	C.B.M.	Size(mm)
Set	10	0.68	0.7	0.0008	750x55x20

**10.714 Straight**

	QTY	N.W (kg)	G.W (kg)	C.B.M.	Size(mm)
Set	10	0.7	0.72	0.0007	700x55x20

**10.715 Curved / Front**

	QTY	N.W (kg)	G.W (kg)	C.B.M.	Size(mm)
Set	6	0.46	0.48	0.0004	810x55x10

**10.491 Curved / Back**

## Top and Bottom Bar Graphic (4x3)

Top and bottom bar graphic for pop up 4x3.

	QTY	N.W (kg)	G.W (kg)	C.B.M.	Size(mm)
Set	12	0.83	0.85	0.008	750x55x20

**10.716 Straight**

	QTY	N.W (kg)	G.W (kg)	C.B.M.	Size(mm)
Set	12	0.78	0.8	0.0007	700x55x20

**10.717 Curved / Front**

	QTY	N.W (kg)	G.W (kg)	C.B.M.	Size(mm)
Set	8	0.6	0.62	0.0004	810x55x15

**10.492 Curved / Back**

## Graphic Case

Graphic case, adjustable height and portable.



	QTY	N.W (kg)	G.W (kg)	C.B.M.	Size(mm)
Uni.	1	0.4	0.42	0.006	640x100x100

10.074

10.075  Ø 107mm 640-1070mm

	QTY	N.W (kg)	G.W (kg)	C.B.M.	Size(mm)
Uni.	1	0.5	0.52	0.008	780x100x100



10.076

10.077  Ø 107mm 779-1280mm

	QTY	N.W (kg)	G.W (kg)	C.B.M.	Size(mm)
Uni.	0	0.3	0.32	0.004	630x80x60



10.078

10.079  Ø 85mm 630x1070mm

## Light L1 - L2

Spot Light with cable, fitted plugs and bulb. Ideal for roll-up. You can use with the ref.: 10.013, 10.015, 10.022.

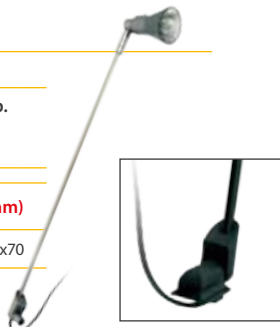

	QTY	N.W (kg)	G.W (kg)	C.B.M.	Size(mm)
Packing	1	0.30	0.40	0.025	460x80x70

10.055

10.056  50 W

## PVC Panel Pop-Up

PVC panel for Pop-Up.



	QTY	N.W (kg)	G.W (kg)	C.B.M.	Size(mm)
Packing	1	1.15	2.5	0.015	890x130x130

10.101 2400x880x0,4mm

## Magnetic Strip Roll 12mm

Magnetic strip roll.



	QTY	N.W (kg)	G.W (kg)	C.B.M.	Size(mm)
Packing	10	9	10	0.02	290x290x200

10.360

## Light L3

Spot Light with cable, fitted plugs and bulb. Ideal for roll-up. You can use with the ref.: 10.014, 10.016, 10.017, 10.018, 10.365, 10.510, 10.511, 10.512, 10.801.



	QTY	N.W (kg)	G.W (kg)	C.B.M.	Size(mm)
Packing	1	0.30	0.35	0.002	400x100x70

10.057 50 W

## Spotlight Roll Up



Spotlight for roll up.



	QTY	N.W (kg)	G.W (kg)	C.B.M.	Size(mm)
Packing	1	0.30	0.35	0.0016	125x200x65

10.525 60 W

## Light L4

Spot Light with cable, fitted plugs and bulb. Ideal for pop-up.



	QTY	N.W (kg)	G.W (kg)	C.B.M.	Size(mm)
Packing	1	0.65	0.7	0.038	510x150x50

10.368 150 W

## LED Light Clamp

Led light clamp for roll-up.



	QTY	N.W (kg)	G.W (kg)	C.B.M.	Size(mm)
Packing	1	0.4	0.8	0.038	510x150x50

10.687 12 W

## LED Light Pop Up

Led light clamp for pop up.



	QTY	N.W (kg)	G.W (kg)	C.B.M.	Size(mm)
Packing	1	0.45	0.85	0.038	510x150x50

10.688 12 W

## 1 Extension Banner Vilamoura



Telescopic banner system. Telescopic poles with adjustable height and with. Lightweight components. Break down easily for transportation.

- Minimum graphic size: 880mm high x 1300mm length.
- Maximum graphic size: 2425mm high x 1850mm length.

**Material:** Steel, plastic parts.

	QTY	N.W(kg)	G.W(kg)	C.B.M.	Size(mm)
Packing	1	6.6	8	0.027	1000x240x115

10.498  Vilamoura



## Montijo



Steel support. 300mm diameter and 200mm high. It's ok for 10mm thickness graphic support.

**Material:** Steel.

	QTY	N.W(kg)	G.W(kg)	C.B.M.	Size(mm)
Packing	2	9.35	9.85	0.027	330x330x250

10.898

10.838  Ø 300mm Pack 2 Uni.

## Warhol



Elegant steel support. size 400x200x300mm high. It's ok for 10mm thickness graphic support.

**Material:** Steel.

34.610

Pack 2 Uni.

34.611

## PanelFix Wing Steel

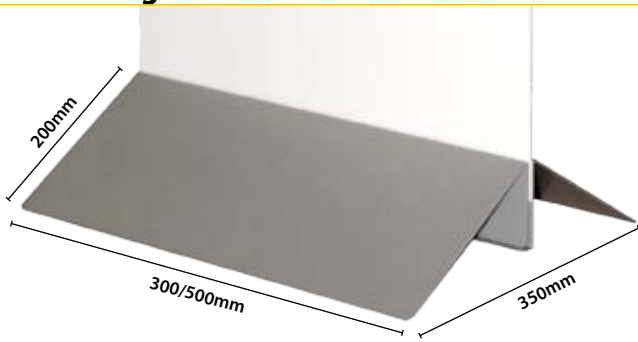

The system is mainly based on screwing the 2 pieces of the bases to each other so that your poster stands still. You can adjust it referring to your poster's thickness. Max height of your poster can be 1500mm. Also we can print any logo on 2 sides of the base. It can be used in all indoor areas such as schools, seminars, restaurant chains, showrooms, exhibition areas, malls and everywhere else.

**Material:** Steel.

	QTY	N.W(kg)	G.W(kg)	C.B.M.	Size(mm)
<b>Packing</b>	1	2.75	2.95	0.0069	330x210x100
<b>10.065</b>	<b>300mm</b>				
	QTY	N.W(kg)	G.W(kg)	C.B.M.	Size(mm)
<b>Packing</b>	1	4.55	4.85	0.011	530x210x100
<b>10.066</b>	<b>500mm</b>				

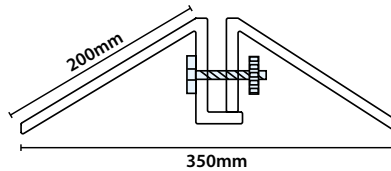

## PanelFix Wing

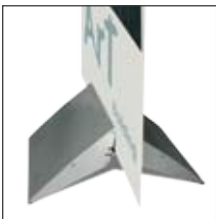

Aluminium base support. Could be use with graphic of 3mm to 26mm thickness. Available in 2 differents sizes, 350 and 550mm.

**Material:** Aluminium.

	QTY	N.W(kg)	G.W(kg)	C.B.M.	Size(mm)
<b>Packing</b>	1	2.6	3	0.011	385x315x93
<b>10.869</b>	<b>350mm</b>				
	QTY	N.W(kg)	G.W(kg)	C.B.M.	Size(mm)
<b>Packing</b>	1	4.15	4.6	0.017	585x315x93
<b>10.870</b>	<b>550mm</b>				



# POSTER DISPLAY

1

## PanelFix Wing Outdoor



Heavy plastic water filled stand for graphic support. Available in grey or black colour.

**Material:** Plastic.

	QTY	N.W(kg)	G.W(kg)	C.B.M.	Size(mm)
Uni.	1	2	2.55	0.04	520x440x190

10.442

10.443



## Algora

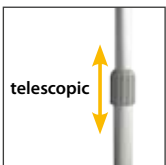

Telescopic banner system. Adjustable height.

**Material:** Steel.

	QTY	N.W (kg)	G.W (kg)	C.B.M.	Size(mm)
Packing	1	1.2	1.6	0.02	1200x270x70

10.803 840x1000-1600mm



## Oropesa

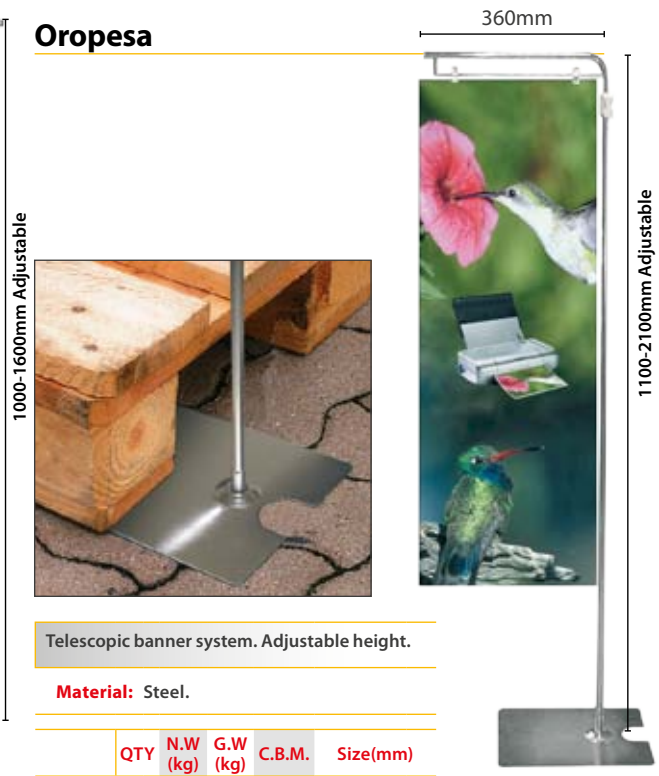

Telescopic banner system. Adjustable height.

**Material:** Steel.

	QTY	N.W (kg)	G.W (kg)	C.B.M.	Size(mm)
Base	1	1.16	1.2	0.0016	320x260x20
Uni.	1	0.8	0.85	0.0015	118x420x30

10.432 360x1100-2100mm

## Sonseca



Banner stand Oropesa. Adjustable height. It's ok for 5mm to 10mm thickness graphic support. Double sided.

**Material:** Steel, plastic parts.

	QTY	N.W(kg)	G.W(kg)	C.B.M.	Size(mm)
Uni.	1	1.95	2	0.01	1240x120x40

10.435



## Alcolea



Poster banner. Adjustable height. The position can be adjusted. Includes:

- Pole.
- 8 supports
- Clips.
- Steel base.

**Material:** Steel, plastic parts.

	QTY	N.W (kg)	G.W (kg)	C.B.M.	Size(mm)
Packing	1	12	13.2	0.033	310x100x1050

10.807



## Exhibition Wall Arenas



Folding panel kit. Quick and easy to assemble. Special offer applies to 600x900mm panel size. Graphic size: 538x845mm each panel.

**Material:** Aluminium, plastic parts.

	QTY	N.W (kg)	G.W (kg)	C.B.M.	Size(mm)
Packing	1	7.3	11	0.12	950x640x200

10.041

2400x1800mm

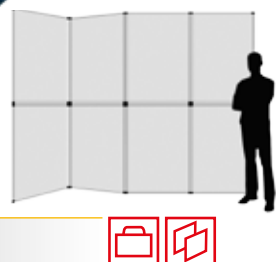

## TexFix

Aluminium Profile solutions for textile digital printing. Different profiles available in standard sizes or in linear meters. Easy and quick to assembly. The fabric should be sewn into a "silicon strip" across her profile, which is then inserted in the insertion of the grid being so tight and perfectly framed and presented.

**Material:** Aluminium.



### Setup

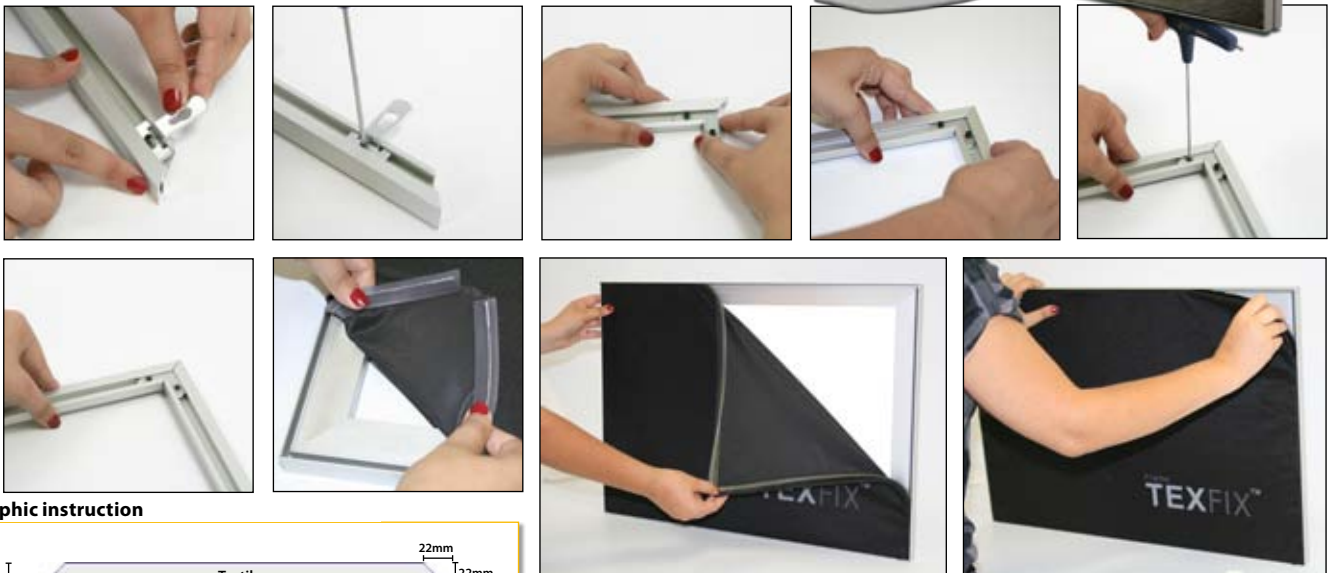

### Graphic instruction

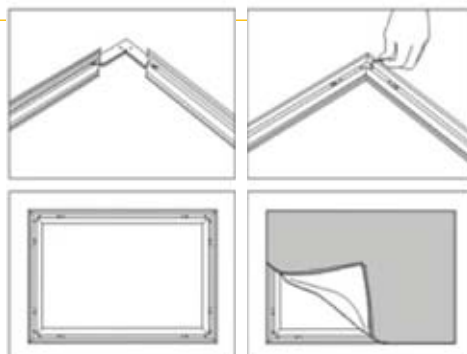
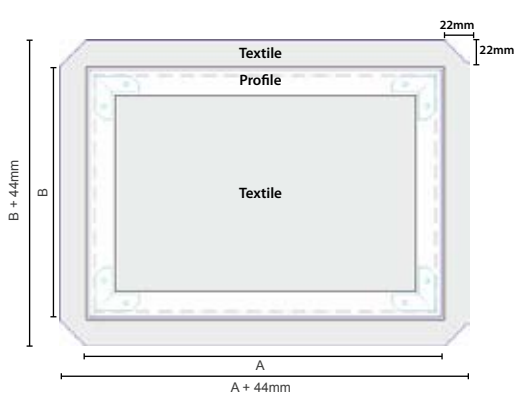



## TexFix Frame 14mm

Simple profile for aluminium frame production for textiles using digital printing.

**Material:** Aluminium.

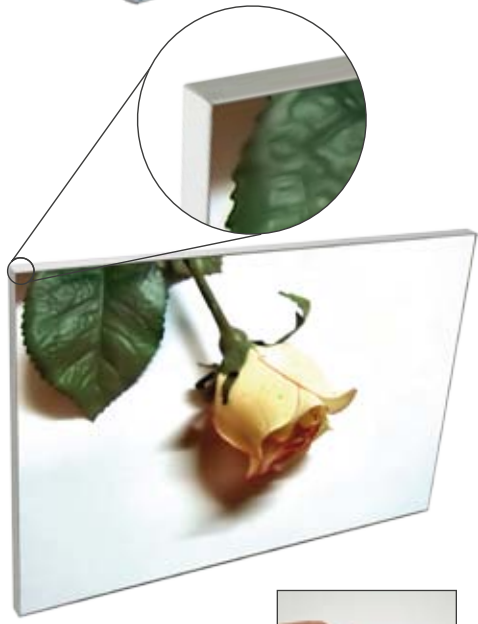
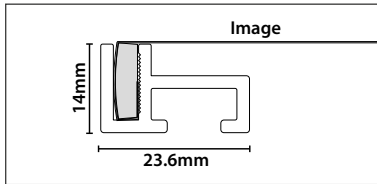

13.132	210x297mm	<input type="checkbox"/>	<input type="checkbox"/>
13.133	297x420mm	<input type="checkbox"/>	<input type="checkbox"/>
13.134	420x594mm	<input type="checkbox"/>	<input type="checkbox"/>
13.135	594x841mm	<input type="checkbox"/>	<input type="checkbox"/>
13.136	500x700mm	<input type="checkbox"/>	<input type="checkbox"/>
13.137	700x1000mm	<input type="checkbox"/>	<input type="checkbox"/>
13.138	500x1000mm	<input type="checkbox"/>	<input type="checkbox"/>

Aluminium profile in linear meters includes 4 units with 3 mts. length each. Total 12 mts.

13.139	Pack 4 uni. x 3m/l = 12m/l	<input type="checkbox"/>
--------	----------------------------	--------------------------

Corner connector.

13.171	Pack 20 Uni.	<input type="checkbox"/>
--------	--------------	--------------------------

## TexFix Wall Frame 25mm

Simple profile for aluminium frame wall production for textiles using digital printing.

**Material:** Aluminium.

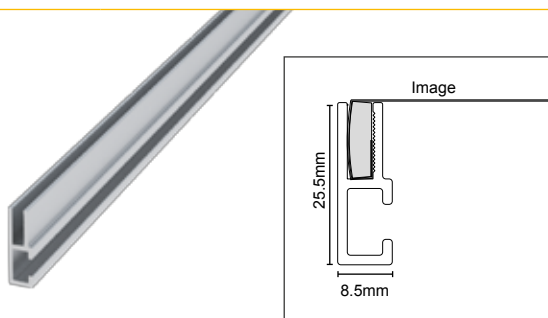

Standard sizes, complete kit.

	(A-B)	(C)		
13.140	210x297mm	-	<input type="checkbox"/>	
13.141	297x420mm	-	<input type="checkbox"/>	
13.142	420x594mm	-	<input type="checkbox"/>	
13.143	594x841mm	-	<input type="checkbox"/>	
13.144	841x1189mm	824mm	<input type="checkbox"/>	
13.150	500x700mm		<input type="checkbox"/>	
13.151	700x1000mm	-	<input type="checkbox"/>	
13.152	1000x1400mm	983mm	<input type="checkbox"/>	
13.153	500x1000mm	-	<input type="checkbox"/>	
13.154	1000x1000mm	-	<input type="checkbox"/>	
13.155	1000x1500mm	983mm	<input type="checkbox"/>	
13.156	1000x2000mm	983mm	<input type="checkbox"/>	

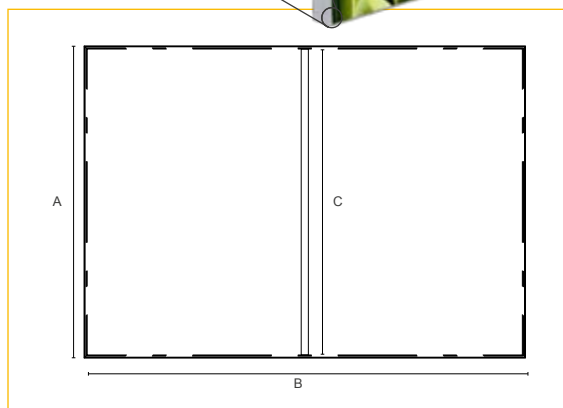

Aluminium profile in linear meters includes 4 units with 3 mts. length each. Total 12 mts.

**13.157 Pack 4 uni. x 3m/l = 12m/l**

Corner connector.

**13.243 Pack 20 Uni.**

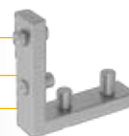

## TexFix Frame 37.5mm Double Sided

Double profile for aluminium frame using digital printing textile.  
Used with feet to be placed on a floor.

**Material:** Aluminium.

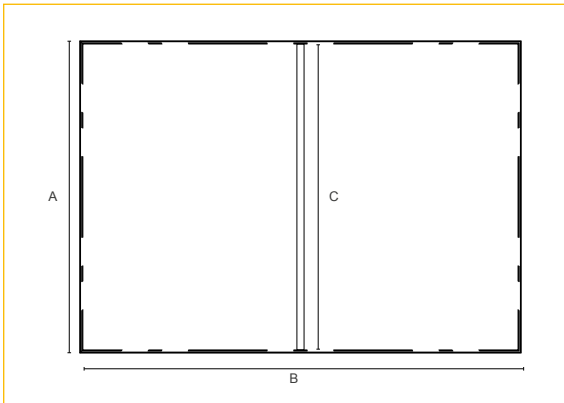
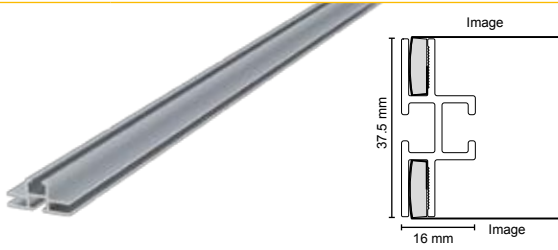

Standard sizes, complete kit.

	(A-B)	(C)		
13.158	210x297mm	-	<input type="checkbox"/>	
13.159	297x420mm	-	<input type="checkbox"/>	
13.160	420x594mm	-	<input type="checkbox"/>	
13.161	594x841mm	-	<input type="checkbox"/>	
13.162	841x1189mm	810mm	<input type="checkbox"/>	
13.163	500x700mm		<input type="checkbox"/>	
13.164	700x1000mm	669mm	<input type="checkbox"/>	
13.165	1000x1400mm	969mm	<input type="checkbox"/>	
13.166	500x1000mm	-	<input type="checkbox"/>	
13.167	1000x1000mm	-	<input type="checkbox"/>	
13.168	1000x1500mm	969mm	<input type="checkbox"/>	
13.169	1000x2000mm	969mm	<input type="checkbox"/>	

Aluminium profile in linear meters includes 4 units with 3 mts. length each. Total 12 mts.

13.170	Pack 4 uni. x 3m/l = 12m/l	<input type="checkbox"/>	
--------	----------------------------	--------------------------	--



Corner connector.









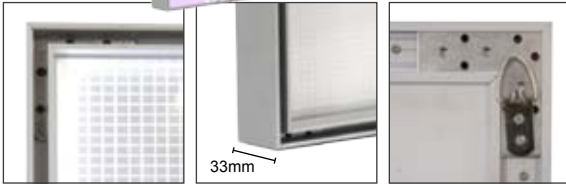

13.243	Pack 20 Uni.	<input type="checkbox"/>	
--------	--------------	--------------------------	--

## TexFix Light Box (LED)

Light box aluminium textile frame. Only in standard sizes.

**Material:** Aluminium.



		Frame size	Viewing size	G.W(kg)	C.B.M.	Size(mm)	
<b>13.180</b>	<b>A4</b>	297x210mm	291x204mm	0.8	0.01	500x50x300mm	 
<b>13.179</b>	<b>A3</b>	420x297mm	414x291mm	1.7	0.02	580x90x460mm	 
<b>13.178</b>	<b>A2</b>	594x420mm	588x414mm	3.3	0.03	730x90x570mm	 
<b>13.177</b>	<b>A1</b>	841x594mm	835x588mm	6.6	0.07	1000x90x770mm	 
<b>13.176</b>	<b>A0</b>	1189x841mm	1183x835mm	13.2	0.12	1340x90x1020mm	 

## Base Straight

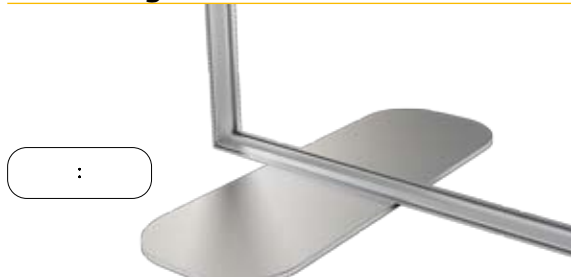

	QTY	N.W (kg)	G.W (kg)	C.B.M.	Size(mm)
Packing	1	5.9	6.1	0.0031	510x175x35

**13.175**    **160x450mm**    **Pack 2 Uni.**

## Base "S"



	QTY	N.W (kg)	G.W (kg)	C.B.M.	Size(mm)
Packing	1	4.5	4.7	0.0031	510x175x35

**13.174**    **145x500mm**    **Pack 2 Uni.**

## Hangers - TexFix Frame 14mm



	QTY	N.W (kg)	G.W (kg)	C.B.M.	Size(mm)
Packing	20	0.31	0.45	0.0004	85x45x115

**13.172**    **Pack 20 Uni.**

## Hangers - TexFix Frame 37.5mm

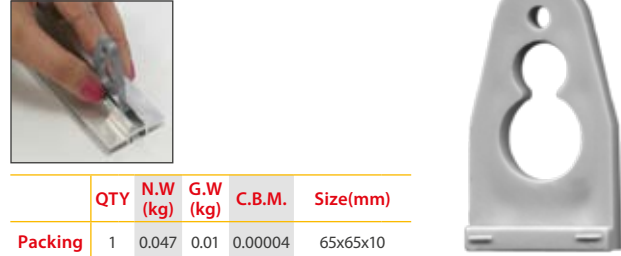

	QTY	N.W (kg)	G.W (kg)	C.B.M.	Size(mm)
Packing	1	0.047	0.01	0.00004	65x65x10

**10.197**    **Pack 10 Uni.**

## Corner Connector



**13.171**    **Pack 20 Uni.**

## Corner Connector



**13.243**    **Pack 20 Uni.**

## Central Connector Profile

Aluminium profile in linear meters includes 4 units with 3 mts. lenght each. Total 12 mts.



**13.246**    **Pack 4 uni. x 3m/l = 12m/l**

## Silicon Strip



**13.173**    **10 mts./l**

## Lock



**13.244**

## Quick System

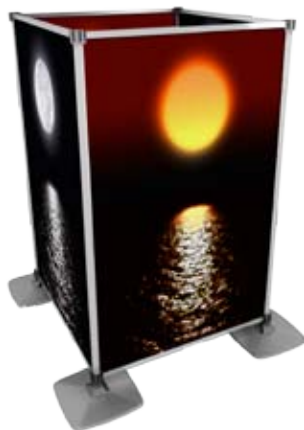







## Telescopic Pole

**Material:** Aluminium, plastic parts.

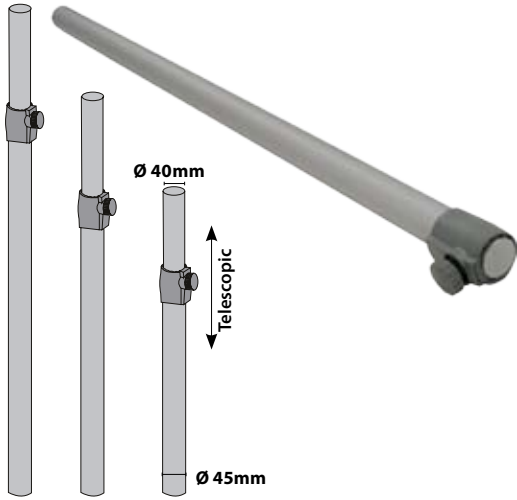

10.961 Ø 45x1200mm

10.962 Ø 45x1600mm

10.963 Ø 45x2000mm

## Base

**Material:** Metal.



10.965

10.964

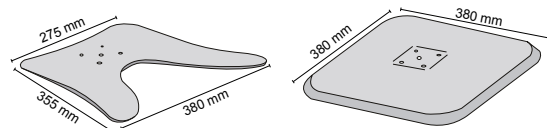

10.965 Base Feet

10.964 Base Square

## Alu Block

**Material:** Plastic.

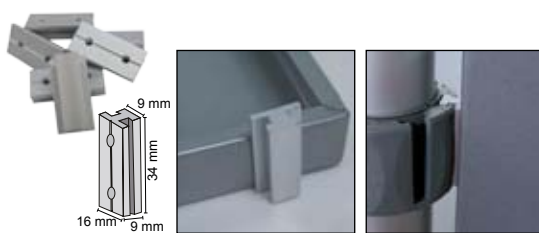

10.969 Pack 10 Uni.

## Pole end Cap

**Material:** Plastic.



10.966 Pack 10 Uni.

## Base Connector

**Material:** Plastic.

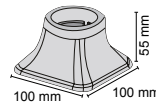

10.967

## 7 Ways connector

**Material:** Plastic.

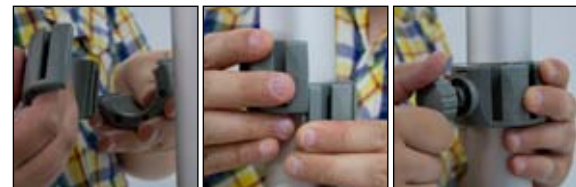

10.968

## Rail

**Material:** Aluminium anodized.

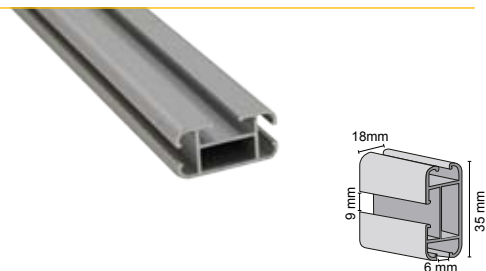

10.970

## PVC Insert

**Material:** PVC.

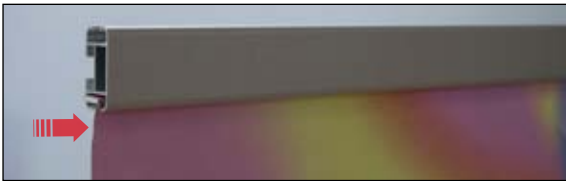

10.862

## Connecting Plate

**Material:** Metal.



10.972



10.973

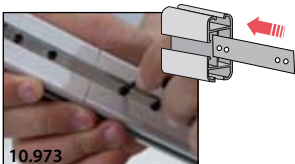

10.973

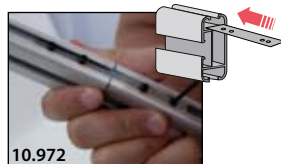

10.972

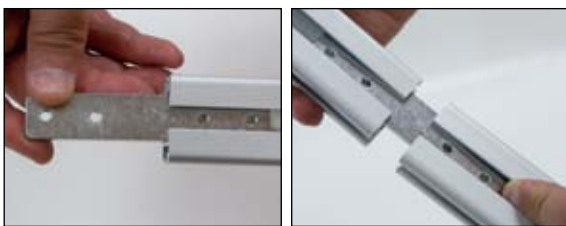

10.972 Pack 10 Uni.

10.973 Pack 10 Uni.

## End Cap

**Material:** Plastic.

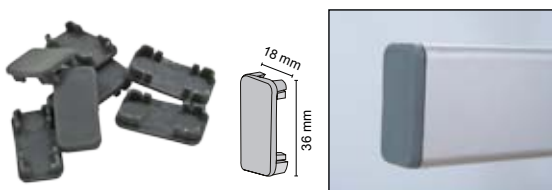

10.971 Pack 10 Uni.

## Side Connecting Block

**Material:** Plastic.



10.863 Pack 10 Uni.

## Back connecting block

**Material:** Plastic.

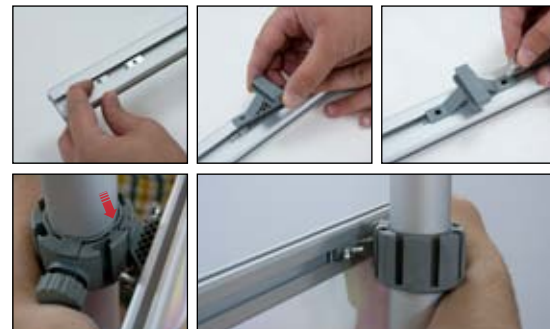
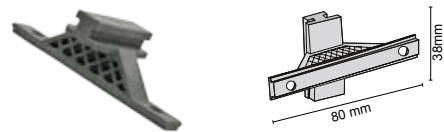

10.864 Pack 10 Uni.

## Wire clip

**Material:** Plastic.

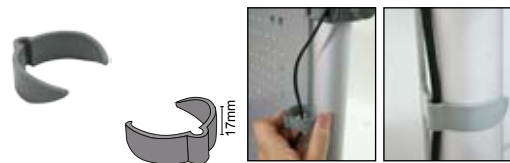

10.541 Ø 45mm Pack 10 Uni.

10.542 Ø 40mm Pack 10 Uni.

## Graphic Clip

**Material:** Plastic.

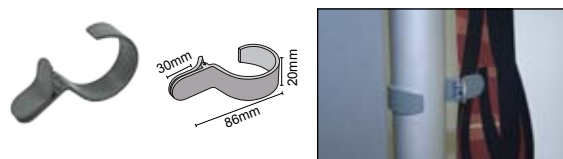

10.539 Ø 45mm Pack 10 Uni.

10.540 Ø 40mm Pack 10 Uni.

## Plastic Clip

**Material:** Plastic.

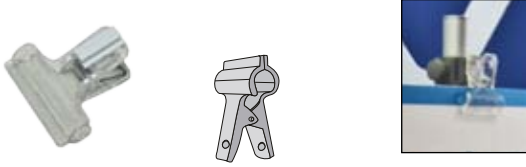

10.537 Pack 10 Uni.

## Side Clip

**Material:** Plastic.

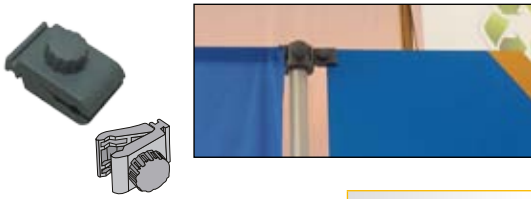

10.538 Pack 10 Uni.

## LCD Bracket

**Material:** Plastic.

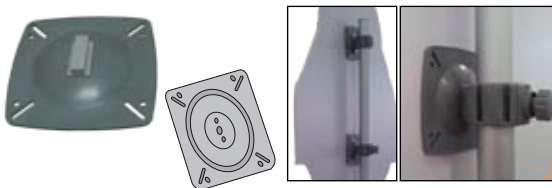

10.543

## Acrylic Brochure Holder

**Material:** Plastic.

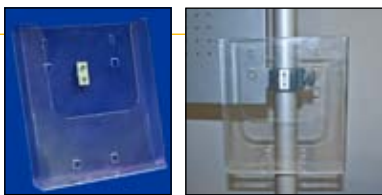

10.544 A4

10.545 A5

10.546 A6

## Spot Light



10.389

## Arc Shelf

**Material:** Metal.



10.959 828x350mm

## Shelf

**Material:** Metal.



10.960 825x400mm

## Panel

**Material:**

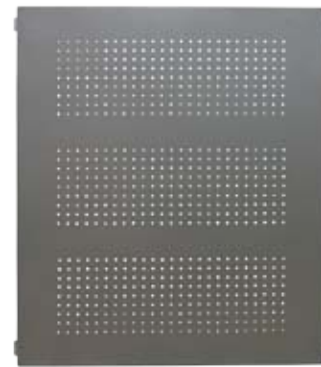

10.958 825x1000mm

## Arc Light Box

**Material:** Metal.



10.957 825x285mm



## 1 Tension Fabric Display Stands

Tension Fabric Display Stands are some of most affordable display system available. They use a full dye sub fabric graphic that fits over a tubular aluminum frame like a pillow case. There is an industrial strength zipper which closes the graphic and creates tension on the system. The full color graphic allows you to place anything on the display to create a stunning graphic backdrop. There are many sizes available so you can find a display that will fit your booth space perfectly.

**Material:** Aluminium.

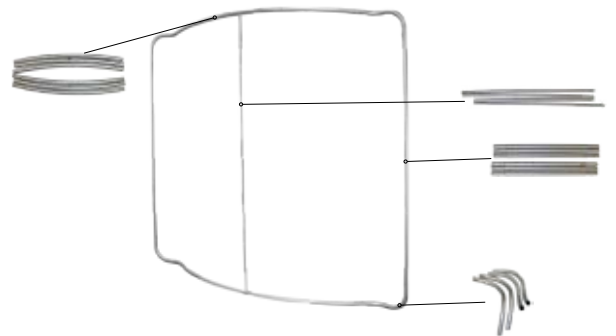

### Telde - 1

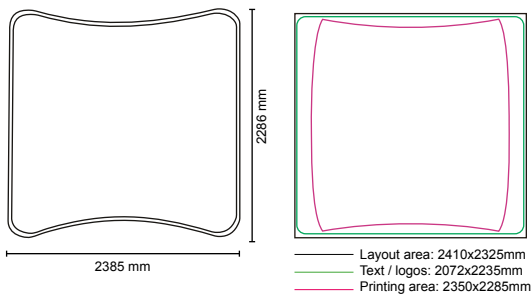

### Telde - 2

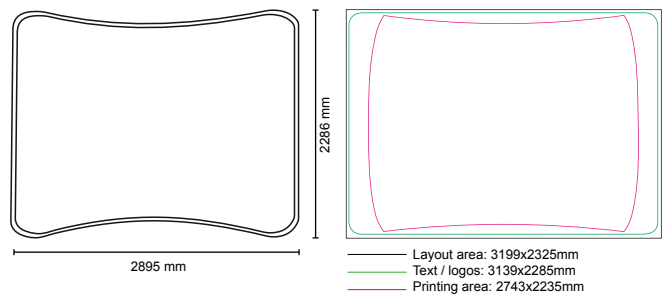

	QTY	N.W (kg)	G.W (kg)	C.B.M.	Size(mm)
Packing	1	4.25	4.70	0.029	730x240x170

	QTY	N.W (kg)	G.W (kg)	C.B.M.	Size(mm)
Packing	1	5.25	5.70	0.029	730x240x170

10.523

2385x2286 mm



10.524

2895x2286 mm



## Tavira

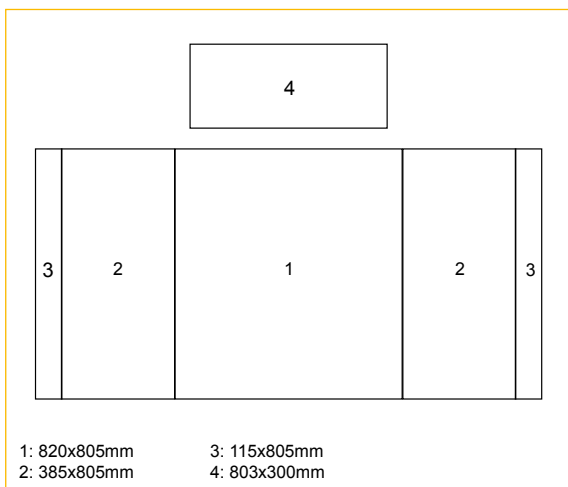

Promotion counter. Easy and fast to assemble. Consist of polystyrene work surface, shelves and base, pole set and Forex header.  
Graphic size:

- Top: 803x300mm.
- Bottom: 1820x805mm.

**Material:** Polystyrene, forex.

	QTY	N.W(kg)	G.W(kg)	C.B.M.	Size(mm)
Packing	1	7.35	8.95	0.073	100x880x840

**10.098      1960x805x440mm**



## Salmoral

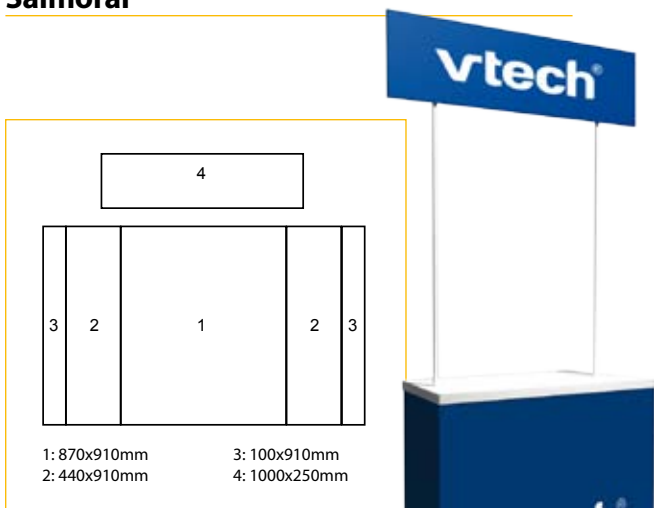

Promotion counter. Easy and fast to assemble. Consist of polystyrene work surface, shelves and base, pole set and Forex header.

Graphic size:

- Top: 1000x250mm.
- Bottom: 1970x910mm.

**Material:** Polystyrene, forex.

	QTY	N.W (kg)	G.W (kg)	C.B.M.	Size(mm)
Packing	1	6.8	8.25	0.051	560x70x1300

**10.043      1900x870x445mm**



## Belvis

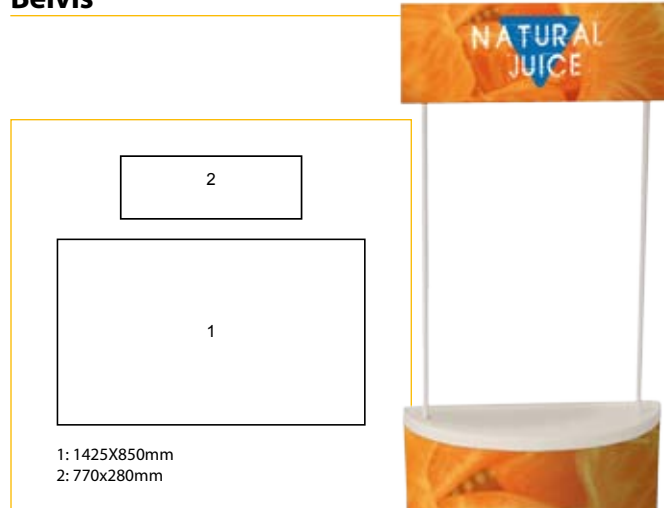

Promotion counter. Easy and fast to assemble. Consist of polystyrene work surface, shelves and base, pole set and Forex header.

Graphic size:

- Top: 770x280mm.
- Bottom: 1420x850mm.

**Material:** Polystyrene, forex.

	QTY	N.W (kg)	G.W (kg)	C.B.M.	Size(mm)
Packing	1	5.8	7.7	0.09	860x120x870

**10.719      2065x790x395mm**



# PROMOTION COUNTERS

1

## Manchester

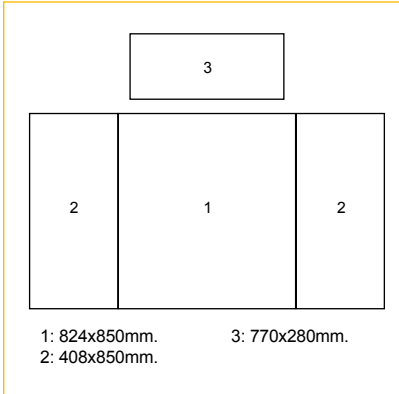

Promotion counter. Easy and fast to assemble.  
White colour. Graphic size:  
• Top: 770x280mm.  
• Bottom: 1640x850mm.

**Material:** Polystyrene, forex.

	QTY	N.W (kg)	G.W (kg)	C.B.M.	Size(mm)
Packing	1	9.5	10.5	0.08	880x860x110

**10.676**      **824x2100mm**



## Lake

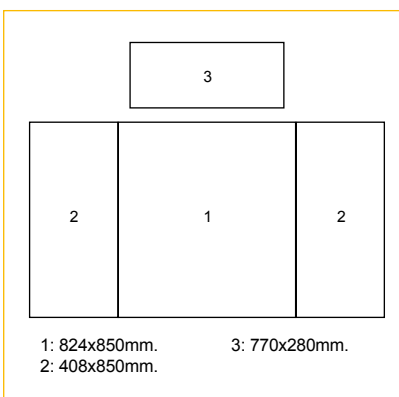

Promotion counter. Easy and fast to assemble.  
Black colour. Graphic size:  
• Top: 770x280mm.  
• Bottom: 1640x850mm.

**Material:** Polystyrene, forex.

	QTY	N.W (kg)	G.W (kg)	C.B.M.	Size(mm)
Packing	1	8.5	9.5	0.08	880x860x110

**10.675**      **825x2100mm**



## Sigüenza

2	1	2
---	---	---

1: 1004x858mm.  
2: 322x858mm.



Promotion counter. Easy and fast to assemble. Lock includes.

**Material:** Aluminium, wood.

	QTY	N.W(kg)	G.W(kg)	C.B.M.	Size(mm)
<b>Packing</b>	1	27	30	0.23	1250x950x200

10.493



## Sepúlveda

4	3	4
2	1	2

1: 1004x858mm      3: 1122x227mm  
2: 322x858mm      4: 212x227mm



Promotion counter. Easy and fast to assemble. Lock includes.

**Material:** Aluminium, wood.

	QTY	N.W(kg)	G.W(kg)	C.B.M.	Size(mm)
<b>Packing</b>	1	36.8	41.9	0.18	1190x940x160

10.494



# PROMOTION COUNTERS

1

## Cebreros



Magnetic pop-up counter. Lightweight and portable.  
Size: 1260x970x360mm.

**Material:** Wood, aluminium, plastic parts.

	QTY	N.W(kg)	G.W(kg)	C.B.M.	Size(mm)
Bottom	1	7.55	9.55	0.06	1030x380x160
Top	1	6.7	8.35	0.04	750x460x110

**10.042**      **2035x945mm**



## Villares

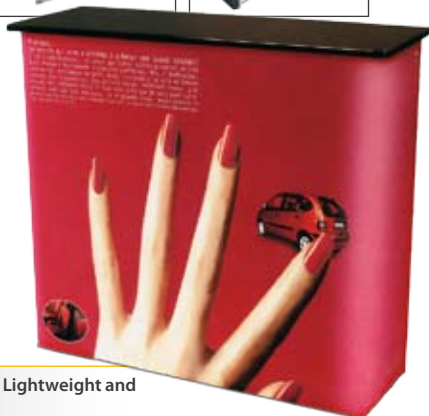

Velcro pop-up counter. Lightweight and portable.

**Material:** Wood, aluminium, plastic parts.

	QTY	N.W (kg)	G.W (kg)	C.B.M.	Size(mm)
Bottom	1	3.1	6.85	0.12	1130x230x445
Top	1	5.45	6.6	0.04	1120x465x70

**10.096**      **1770x1000mm**



## Cezures



Promotion Counter. Easy and fast to assemble.

**Material:** Wood, plastic.

	QTY	N.W (kg)	G.W (kg)	C.B.M.	Size(mm)
Packing	2	7.7	15	0.02	570x380x940

**10.686**      **1700x900mm**





## Valdés



Promotion counter. Easy and fast to assemble.

**Material:** Wood, plastic.

	QTY	N.W (kg)	G.W (kg)	C.B.M.	Size(mm)
Packing	2	6.4	13	0.016	490x330x960

**10.685**      **1225x900mm**



## Javea



Simple counter suitable for exhibition, demonstration and other kind of presentation. Foldable. Three different colours.

**Material:** Steel, colour plastic parts.

	QTY	N.W (kg)	G.W (kg)	C.B.M.	Size(mm)
Packing	2	13	15.75	0.11	730x520x290
Uni.	1	6.5	7.25	0.047	500x350x270

**10.672**

**10.673**

**10.674**



## Libourne



Simple counter suitable for exhibition, demonstration and other kind of presentation. Foldable and easy to transport and mount.

**Material:** Wood, steel.

	QTY	N.W(kg)	G.W(kg)	C.B.M.	Size(mm)
Packing	1	7.35	7.8	0.03	400x540x160

**10.417**      **370x510x980mm**



# POSTER SYSTEM

1

## CheapClip

Suitable for heavier and bigger poster. No tool assembly. Each kit includes profile bar and hangers. Available in black, white or clear.

**Material:** Plastic.

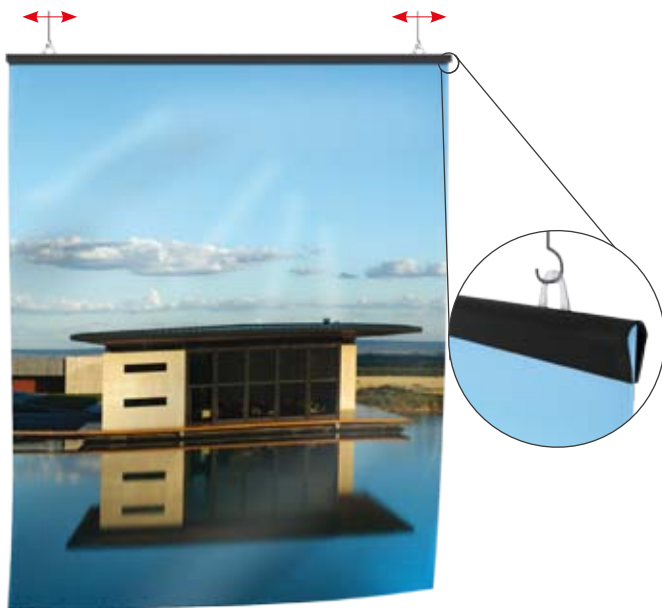
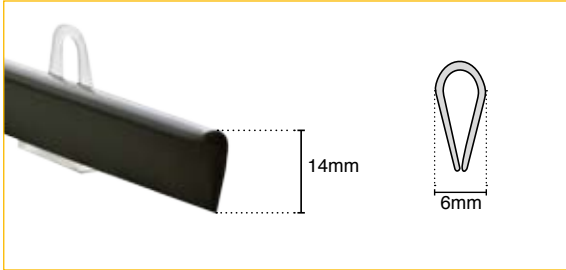

## SoftClip

Suitable for heavier and bigger poster. No tool assembly. Each kit includes one plastic bar and two hangers. Available in 3 different colors, black, white or clear.

**Material:** Plastic.

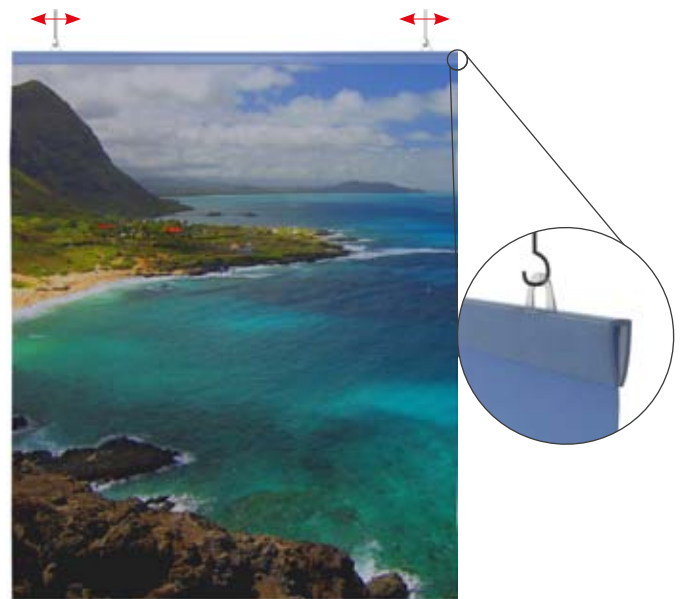
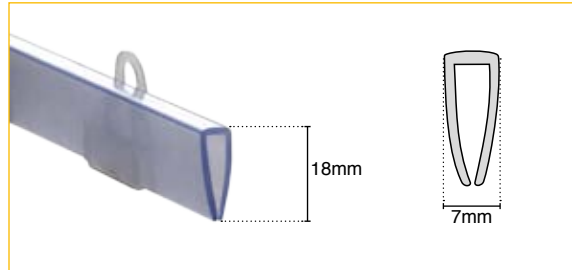

	QTY	N.W (kg)	G.W (kg)	C.B.M.	Size(mm)
Packing	3	0.04	0.05	0.09	520x90x20

**10.621**  clear

**10.622**

**10.623**  500mm Pack 3 Uni.

	QTY	N.W (kg)	G.W (kg)	C.B.M.	Size(mm)
Packing	3	0.07	0.08	0.14	820x90x20

**10.624**  clear

**10.625**

**10.626**  800mm Pack 3 Uni.

	QTY	N.W (kg)	G.W (kg)	C.B.M.	Size(mm)
Packing	3	0.09	0.1	1.11	1020x90x20

**10.627**  clear

**10.628**

**10.629**  1000mm Pack 3 Uni.

	QTY	N.W (kg)	G.W (kg)	C.B.M.	Size(mm)
Packing	3	0.07	0.1	0.09	520x90x20

**10.612**  clear

**10.613**

**10.614**  500mm Pack 3 Uni.

	QTY	N.W (kg)	G.W (kg)	C.B.M.	Size(mm)
Packing	3	0.13	0.16	0.14	820x90x20

**10.615**  clear

**10.616**

**10.617**  800mm Pack 3 Uni.

	QTY	N.W (kg)	G.W (kg)	C.B.M.	Size(mm)
Packing	3	0.18	0.21	1.11	1020x90x20

**10.618**  clear

**10.619**

**10.620**  1000mm Pack 3 Uni.

## BestClip

Suitable for heavier and bigger poster. No tool assembly. Each includes profile bar and hangers. Available in 3 different colors.

**Material:** Plastic.

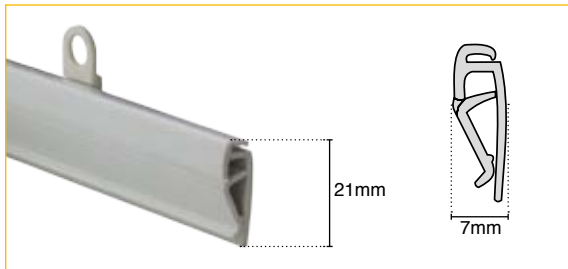

## PlastiClip

Suitable for heavier and bigger poster. No tool assembly. One can simply open the front profile to change your documents. Each kit includes one plastic bar and two hangers. Available in 2 different colors, black or white.

**Material:** Plastic.

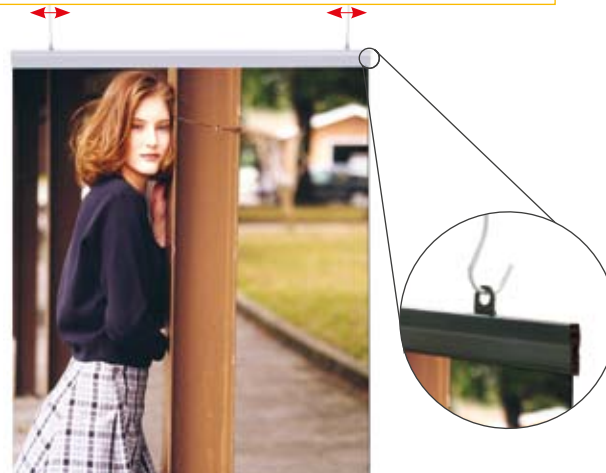
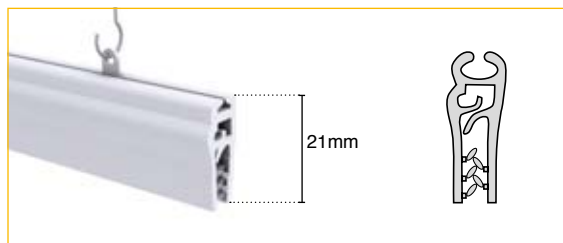

	QTY	N.W (kg)	G.W (kg)	C.B.M.	Size(mm)
Packing	1	0.12	0.14	0.0004	440x65x15

10.526

10.527  440mm Pack 3 Uni.

	QTY	N.W (kg)	G.W (kg)	C.B.M.	Size(mm)
Packing	1	0.15	0.17	0.0005	500x65x15

10.528

10.529  500mm Pack 3 Uni.

	QTY	N.W (kg)	G.W (kg)	C.B.M.	Size(mm)
Packing	1	0.18	0.2	0.0006	600x65x15

10.530

10.531  600mm Pack 3 Uni.

	QTY	N.W (kg)	G.W (kg)	C.B.M.	Size(mm)
Packing	1	0.22	0.25	0.0008	800x65x15

10.532

10.533  800mm Pack 3 Uni.

	QTY	N.W (kg)	G.W (kg)	C.B.M.	Size(mm)
Packing	1	0.27	0.3	0.001	1000x65x15

10.534

10.535  1000mm Pack 3 Uni.

	QTY	N.W (kg)	G.W (kg)	C.B.M.	Size(mm)
Packing	3	0.1	0.13	0.09	520x90x20

10.603  clear

10.604

10.605  500mm Pack 3 Uni.

	QTY	N.W (kg)	G.W (kg)	C.B.M.	Size(mm)
Packing	3	0.16	0.19	0.14	820x90x20

10.606  clear

10.607

10.608  800mm Pack 3 Uni.

	QTY	N.W (kg)	G.W (kg)	C.B.M.	Size(mm)
Packing	3	0.22	0.25	1.11	1020x90x20

10.609  clear

10.610

10.611  1000mm Pack 3 Uni.

# POSTER SYSTEM

1

## StrongClip

Suitable for heavier and bigger poster. No tool assembly. One can simply open the front profile to change your documents. Each kit includes one plastic bar and two hangers. Available in 3 different colors, black, white or clear.

**Material:** Plastic.

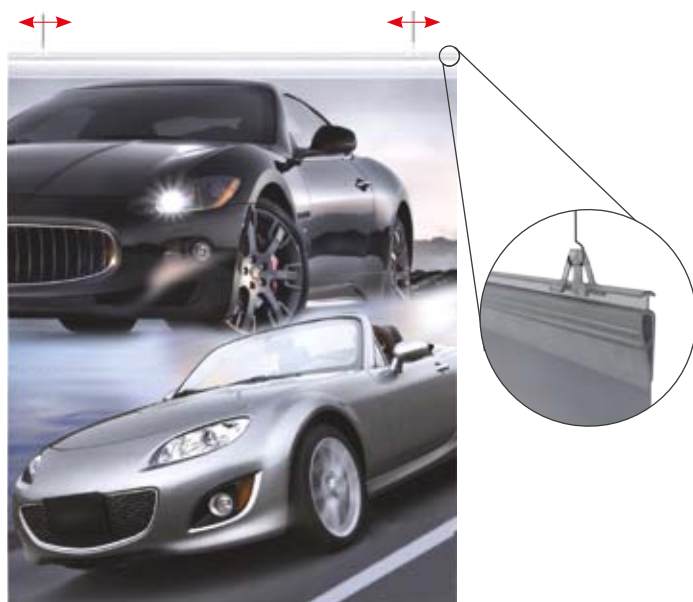
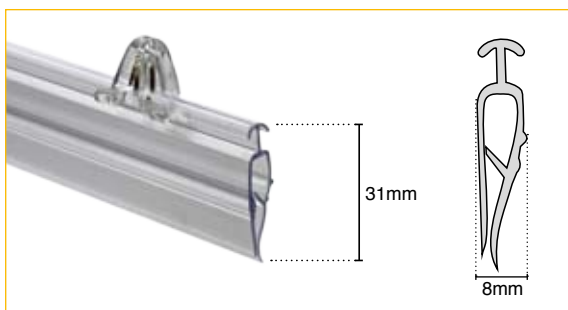

	QTY	N.W (kg)	G.W (kg)	C.B.M.	Size(mm)
Packing	3	0.13	0.16	0.18	520x90x40

**10.630**  clear

**10.631**

**10.632**  **500mm Pack 3 Uni.**

	QTY	N.W (kg)	G.W (kg)	C.B.M.	Size(mm)
Packing	3	0.25	0.27	0.29	820x90x40

**10.633**  clear

**10.634**

**10.635**  **800mm Pack 3 Uni.**

	QTY	N.W (kg)	G.W (kg)	C.B.M.	Size(mm)
Packing	3	0.3	0.33	0.36	1020x90x40

**10.636**  clear

**10.637**

**10.638**  **1000mm Pack 3 Uni.**

## AluGrip

Suitable for heavier and bigger posters. No tool assembly. Each kit includes: 1 bar, gripper, plastic endcaps and hangers.

**Material:** Aluminium, plastic parts.

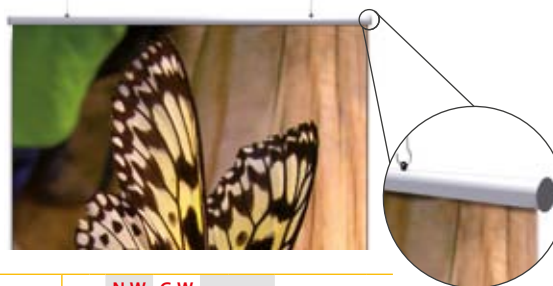
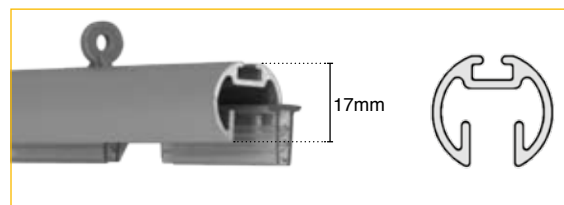

	QTY	N.W (kg)	G.W (kg)	C.B.M.	Size(mm)
Packing	4	0.31	0.5	0.0008	340x50x45

**10.172** **300mm Pack 4 Uni.**

	QTY	N.W (kg)	G.W (kg)	C.B.M.	Size(mm)
Packing	4	0.51	0.7	0.0012	540x50x45

**10.173** **500mm Pack 4 Uni.**

	QTY	N.W (kg)	G.W (kg)	C.B.M.	Size(mm)
Packing	4	0.7	0.85	0.0017	740x50x45

**10.174** **700mm Pack 4 Uni.**

	QTY	N.W (kg)	G.W (kg)	C.B.M.	Size(mm)
Packing	4	1	1.4	0.0023	1040x50x45

**10.175** **1000mm Pack 4 Uni.**

## Accessories Alugrip

	QTY	N.W (kg)	G.W (kg)	C.B.M.	Size(mm)
Packing	1	0.02	0.03	0.00004	65x65x10

**10.176** **10 Gripper 50mm**

	QTY	N.W (kg)	G.W (kg)	C.B.M.	Size(mm)
Packing	1	0.05	0.01	0.00004	65x65x10

**10.177** **10 Plastic Endcaps**

	QTY	N.W (kg)	G.W (kg)	C.B.M.	Size(mm)
Packing	1	0.006	0.01	0.00004	65x65x10

**10.178** **10 Alugrip Hangers**

	QTY	N.W (kg)	G.W (kg)	C.B.M.	Size(mm)
Packing	1	0.006	0.01	0.00004	65x65x10

**10.179** **10 Alugrip Hangers**

## AluPoster

Suitable for heavier and bigger posters. No tool assembly. One can simply open the front profile to change your documents. Each kit includes: 1 bar, plastic endcaps and hangers.

**Material:** Aluminium, plastic parts.

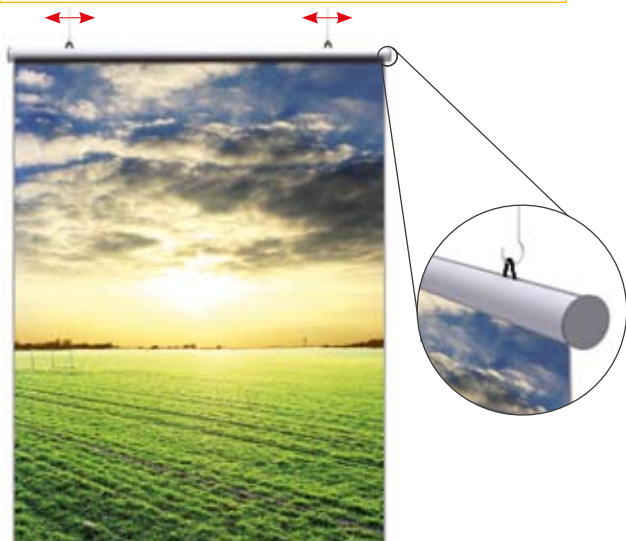
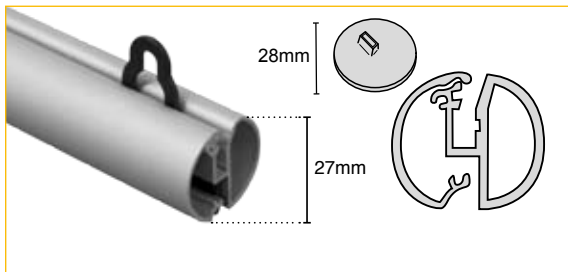

## AluClip

Suitable for heavier and bigger posters. No tool assembly. One can simply open the front profile to change your documents. Each kit includes: 1 bar, plastic endcaps and hangers.

**Material:** Aluminium, plastic parts.

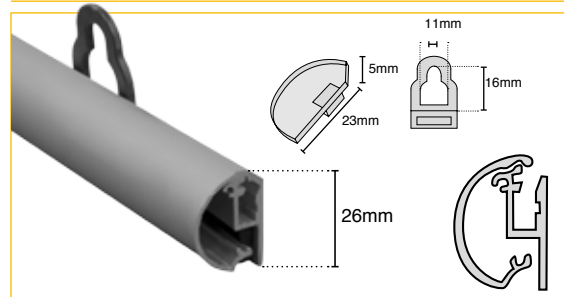

	QTY	N.W (kg)	G.W (kg)	C.B.M.	Size(mm)
Packing	1	0.1	0.12	0.0004	310x40x30

**10.086 300mm**

	QTY	N.W (kg)	G.W (kg)	C.B.M.	Size(mm)
Packing	1	0.18	0.2	0.0006	510x30x40

**10.087 500mm**

	QTY	N.W (kg)	G.W (kg)	C.B.M.	Size(mm)
Packing	1	0.28	0.3	0.0009	810x30x40

**10.088 800mm**

	QTY	N.W (kg)	G.W (kg)	C.B.M.	Size(mm)
Packing	1	0.37	0.4	0.001	1010x30x40

**10.089 1000mm**

	QTY	N.W (kg)	G.W (kg)	C.B.M.	Size(mm)
Packing	1	0.42	0.45	0.001	1210x30x40

**10.090 1200mm**

	QTY	N.W (kg)	G.W (kg)	C.B.M.	Size(mm)
Packing	1	0.5	0.55	0.001	1510x40x30

**10.091 1500mm**

	QTY	N.W (kg)	G.W (kg)	C.B.M.	Size(mm)
Packing	1	0.05	0.08	0.0002	350x20x30

**10.080 300mm**

	QTY	N.W (kg)	G.W (kg)	C.B.M.	Size(mm)
Packing	1	0.1	0.15	0.0003	510x20x30

**10.081 500mm**

	QTY	N.W (kg)	G.W (kg)	C.B.M.	Size(mm)
Packing	1	0.2	0.22	0.0005	810x20x30

**10.082 800mm**

	QTY	N.W (kg)	G.W (kg)	C.B.M.	Size(mm)
Packing	1	0.25	0.3	0.0006	1000x20x30

**10.083 1000mm**

	QTY	N.W (kg)	G.W (kg)	C.B.M.	Size(mm)
Packing	1	0.3	0.35	0.001	1200x20x30

**10.084 1200mm**

	QTY	N.W (kg)	G.W (kg)	C.B.M.	Size(mm)
Packing	1	0.35	0.40	0.001	1510x20x30

**10.085 1500mm**

## AluLon

Suitable for heavier and bigger posters. No tool assembly. Each kit includes: 1 bar, plastic endcaps and hangers.

**Material:** Aluminium, plastic parts.



	QTY	N.W (kg)	G.W (kg)	C.B.M.	Size(mm)
Packing	4	1.2	1.4	0.0017	540x90x35

**10.571 500mm Pack 4 Uni.**

	QTY	N.W (kg)	G.W (kg)	C.B.M.	Size(mm)
Packing	4	1.8	2.1	0.0026	840x90x35

**10.191 800mm Pack 4 Uni.**

	QTY	N.W (kg)	G.W (kg)	C.B.M.	Size(mm)
Packing	4	2.2	2.6	0.0033	1040x90x35

**10.572 1000mm Pack 4 Uni.**

	QTY	N.W (kg)	G.W (kg)	C.B.M.	Size(mm)
Packing	4	2.7	3	0.0039	1240x90x35

**10.193 1200mm Pack 4 Uni.**

	QTY	N.W (kg)	G.W (kg)	C.B.M.	Size(mm)
Packing	4	3.4	3.8	0.0049	1540x90x35

**10.194 1500mm Pack 4 Uni.**

	QTY	N.W (kg)	G.W (kg)	C.B.M.	Size(mm)
Packing	4	6.5	7.4	0.0123	3025x90x45

**10.195 3000mm Pack 4 Uni.**

## Accessories Alulon

	QTY	N.W (kg)	G.W (kg)	C.B.M.	Size(mm)
Packing	1	0.009	0.02	0.00004	65x65x10

**10.196 10 Plastic Endcaps**

	QTY	N.W (kg)	G.W (kg)	C.B.M.	Size(mm)
Packing	1	0.047	0.01	0.00004	65x65x10

**10.197 10 Ring Clip**

## Decorail

Decorail Kit for graphical support through suspension and positioning system in the guide graphic slotted plastic that hangs below the profile. Ready to make graphical changes quickly and easily. It consists of two elements which are supplied separately, aluminium and plastic profile. Price per linear meter.

**Material:** Aluminium, plastic.

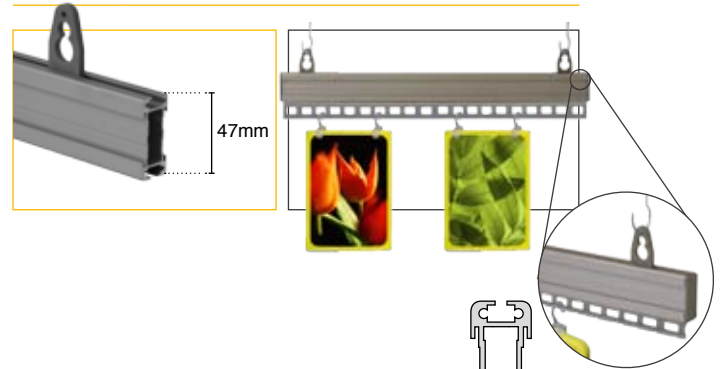

	QTY	N.W (kg)	G.W (kg)	C.B.M.	Size(mm)
Packing	1	0.6	0.63	0.0003	1000x10x30

**50.620 Decorail 3000mm**

	QTY	N.W (kg)	G.W (kg)	C.B.M.	Size(mm)
Packing	1	0.05	0.06	0.0002	1000x10x20

**50.621 Plastic 3000mm**

## Ring Clip

Plastic hanger for different aluminium profiles.

**Material:** Plastic.

Valid for:

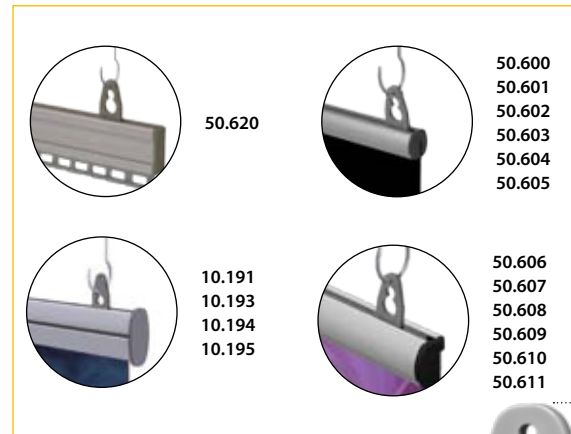

	QTY	N.W (kg)	G.W (kg)	C.B.M.	Size(mm)
Packing	1	0.047	0.01	0.00004	65x65x10

**10.197 10 Ring Clip**

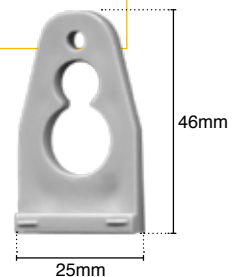

## Fast Clip

Suitable for heavier and bigger posters. No tool assembly. Each kit includes: profile bar, plastic pieces, endcaps and hangers.

**Material:** Aluminium, plastic parts.

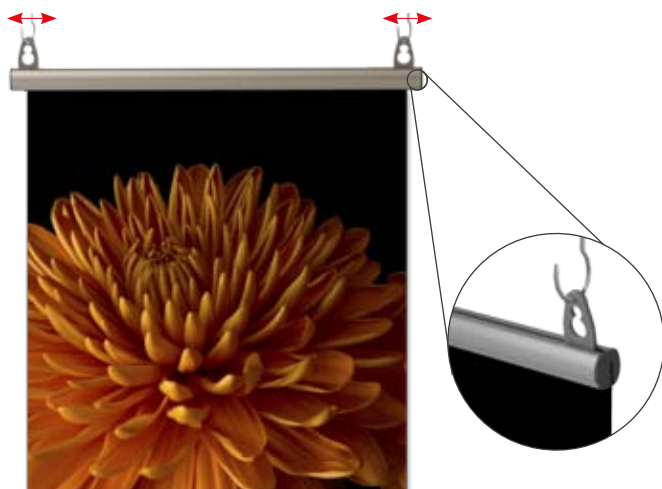
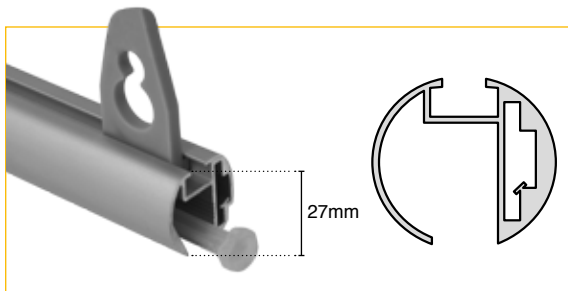

## Semi-Circular Fast Clip

Suitable for heavier and bigger posters. No tool assembly. Each kit includes: profile bar, plastic pieces, endcaps and hangers.

**Material:** Aluminium, plastic parts.

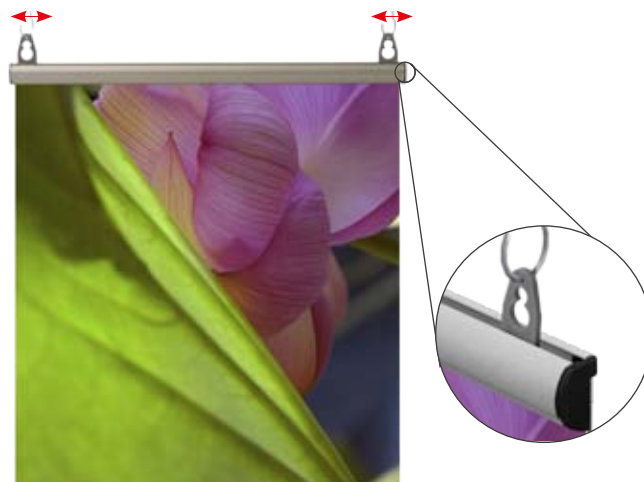
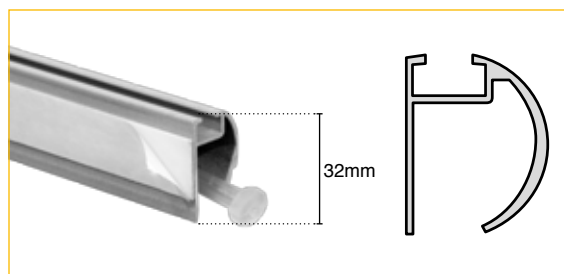

	QTY	N.W (kg)	G.W (kg)	C.B.M.	Size(mm)
Packing	4	0.65	0.8	0.0018	340x90x60

**50.600 300mm Pack 4 Uni.**

	QTY	N.W (kg)	G.W (kg)	C.B.M.	Size(mm)
Packing	4	1.17	1.4	0.0029	540x90x60

**50.601 500mm Pack 4 Uni.**

	QTY	N.W (kg)	G.W (kg)	C.B.M.	Size(mm)
Packing	4	1.7	2	0.0045	840x90x60

**50.602 800mm**

	QTY	N.W (kg)	G.W (kg)	C.B.M.	Size(mm)
Packing	4	2	2.45	0.0056	1040x90x60

**50.603 1000mm Pack 4 Uni.**

	QTY	N.W (kg)	G.W (kg)	C.B.M.	Size(mm)
Packing	4	2.4	2.9	0.0067	1240x90x60

**50.604 1200mm Pack 4 Uni.**

	QTY	N.W (kg)	G.W (kg)	C.B.M.	Size(mm)
Packing	4	2.9	3.5	0.0083	1540x90x60

**50.605 1500mm Pack 4 Uni.**

	QTY	N.W (kg)	G.W (kg)	C.B.M.	Size(mm)
Packing	4	0.45	0.6	0.0015	340x100x45

**50.606 300mm Pack 4 Uni.**

	QTY	N.W (kg)	G.W (kg)	C.B.M.	Size(mm)
Packing	4	0.7	1	0.0024	540x100x45

**50.607 500mm Pack 4 Uni.**

	QTY	N.W (kg)	G.W (kg)	C.B.M.	Size(mm)
Packing	1	1	1.4	0.0038	840x100x45

**50.608 800mm Pack 4 Uni.**

	QTY	N.W (kg)	G.W (kg)	C.B.M.	Size(mm)
Packing	4	1.3	1.8	0.0047	1040x100x45

**50.609 1000mm Pack 4 Uni.**

	QTY	N.W (kg)	G.W (kg)	C.B.M.	Size(mm)
Packing	4	1.5	2.1	0.0056	1250x100x45

**50.610 1200mm Pack 4 Uni.**

	QTY	N.W (kg)	G.W (kg)	C.B.M.	Size(mm)
Packing	4	1.95	2.5	0.0069	1540x100x45

**50.611 1500mm Pack 4 Uni.**

## Dancing Stand



Dancing stand display. Colour grey or blue.

**Material:** Steel, acrylic.

	QTY	N.W (kg)	G.W (kg)	C.B.M.	Size(mm)
Packing	1	11	13	0.09	550x550x300

**10.054**  **350x350x1530mm**



## Twister



Twister Tower. It's a cylindrical aluminium displaying device with crafty structure. In a vertical condition, it could be used as a displaying cabinet or a sales promotion counter.

**Material:** Aluminium.

	QTY	N.W (kg)	G.W (kg)	C.B.M.	Size(mm)
Packing	1	18.3	20.7	0.07	500x500x280

**10.784**  **Calera - Ø 400mm x 2040mm**



## "Easy"

Top part

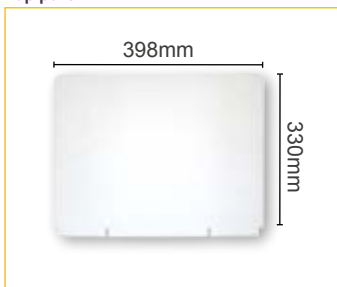

Easy Display. Rectangular shelves, white plastic shelves with clear uprights, all parts can be stacked. No tools required for assembly. Includes white carton for bottom part. Top part includes.

**Material:** Plastic.

	QTY	N.W (kg)	G.W (kg)	C.B.M.	Size(mm)
Packing	1	4	4.8	0.063	705x490x185

**10.478**  **305x405x1620mm**

## Display Shelf



Display Shelf in white, red, blue or black. Rectangular shelves, transparent PVC uprights, all parts can be stacked. No tool required for assembly.

**Material:** Plastic.

	QTY	N.W (kg)	G.W (kg)	C.B.M.	Size(mm)
Packing	1	8	8.45	0.073	400x290x630

**10.384**

**10.386**

**10.387**

**10.388**  **617x400x1480mm**





## Promo Ball



Display Promo Ball. For presentation small and large products. Diameter balls: ± 380mm.

**Material:** Steel, plastic.

	QTY	N.W (kg)	G.W (kg)	C.B.M.	Size(mm)
Packing	1	14	16	0.18	900x450x400

**10.802**      **Ø 400mm x 1800mm**

## Table Display

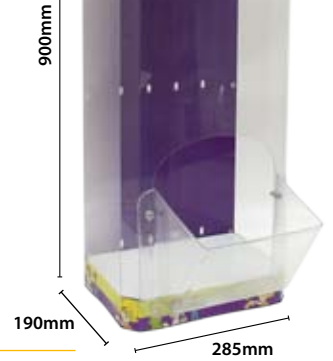

Table Display. Easy and fast to assembly.

**Material:** Plastic.

	QTY	N.W (kg)	G.W (kg)	C.B.M.	Size(mm)
Packing	1	2.5	3.6	0.058	920x300x210

**10.475**      **285x190x900mm**

## Wall Display

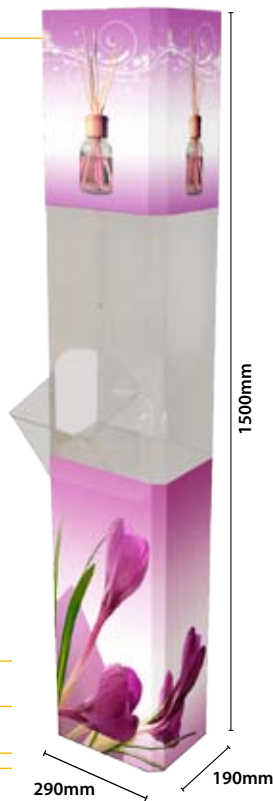

Simple Floor Display. Easy and fast to assembly.

**Material:** Plastic.

	QTY	N.W (kg)	G.W (kg)	C.B.M.	Size(mm)
Packing	1	3.6	4	0.09	1510x200x300

**10.476**      **290x190x1500mm**

## Floor Display

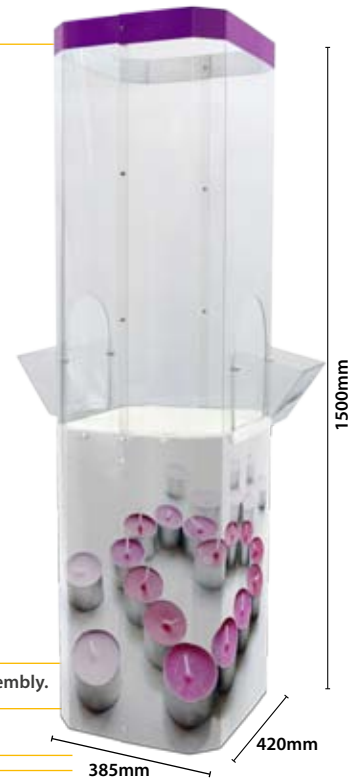

Double Floor Display. Easy and fast to assembly.

**Material:** Plastic.

	QTY	N.W (kg)	G.W (kg)	C.B.M.	Size(mm)
Packing	1	7.35	8.2	0.27	1520x450x400

**10.477**      **385x420x1500mm**

## 1 Promotion Display Bristol/Coventry



Examples:

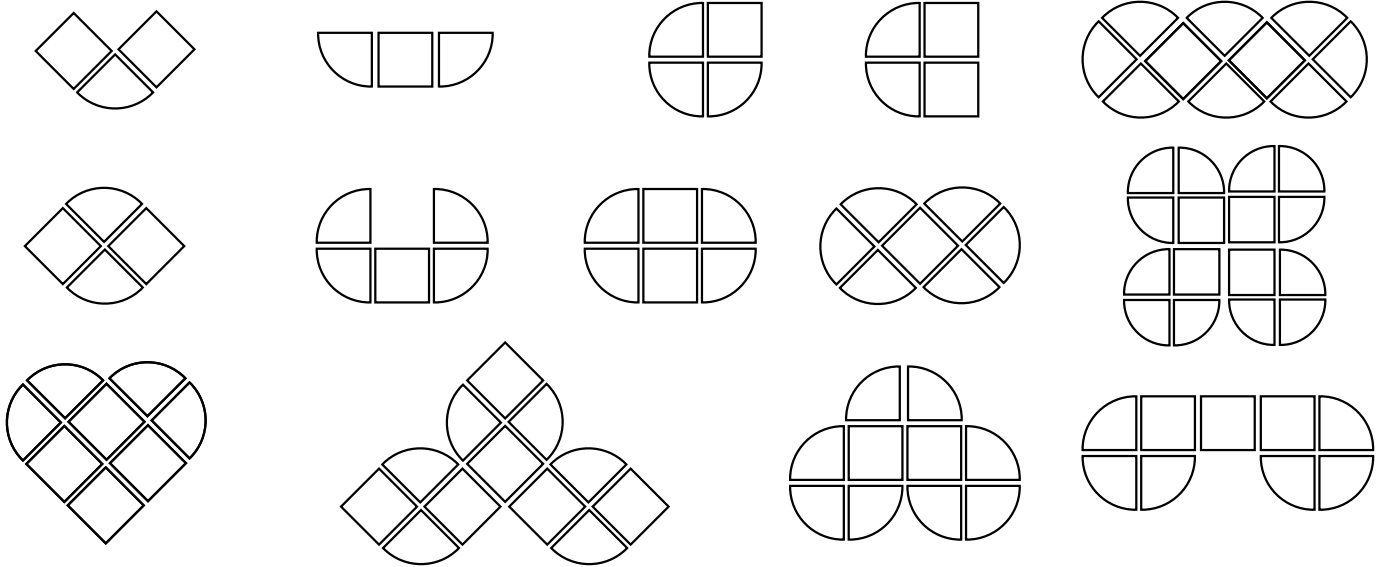

Exhibition display system. Easy and fast combination and assembly.

**Material:** Aluminium, plastic.

	QTY	N.W(kg)	G.W(kg)	C.B.M.	Size(mm)
<b>Packing</b>	1	36.8	41.9	0.18	1190x940x160

**10.677**  **Bristol - 500x500x780mm**

**10.678**  **Coventry - 500x500x780mm**

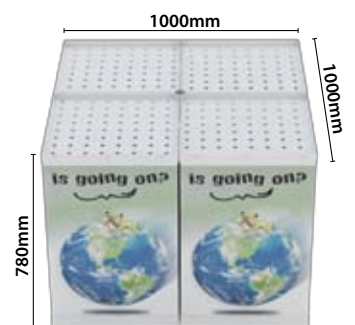
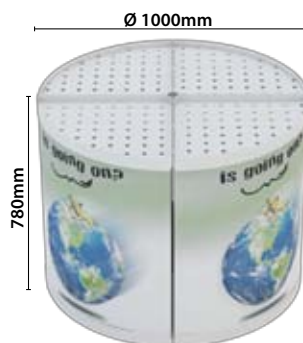

## Chrome Display

Stand for display of products or storage space. Suitable for the home or office. A stand for many uses with a strong and simple structure, capable of holding up to 150 kg.

**Material:** Steel.



### 3 Shelf

	QTY	N.W (kg)	G.W (kg)	C.B.M.	Size(mm)
Packing	1	10.90	11.90	0.045	930x370x130

**34.500 610x910x350mm**

	QTY	N.W (kg)	G.W (kg)	C.B.M.	Size(mm)
Packing	1	13	14	0.045	930x370x130

**34.501 910x910x350**

	QTY	N.W (kg)	G.W (kg)	C.B.M.	Size(mm)
Packing	1	16.50	17.60	0.06	1250x370x120

**34.502 1220x910x350**

### 4 Shelf

	QTY	N.W (kg)	G.W (kg)	C.B.M.	Size(mm)
Packing	1	13.20	14.80	0.058	930x370x170

**34.503 610x1600x350mm**

	QTY	N.W (kg)	G.W (kg)	C.B.M.	Size(mm)
Packing	1	16	17.60	0.058	930x370x170

**34.504 910x1600x350mm**

	QTY	N.W (kg)	G.W (kg)	C.B.M.	Size(mm)
Packing	1	20.80	22.40	0.079	1250x370x170

**34.505 1220x1600x350mm**

	QTY	N.W (kg)	G.W (kg)	C.B.M.	Size(mm)
Packing	1	16	17.60	0.076	930x480x170

**34.506 610x1600x460mm**

	QTY	N.W (kg)	G.W (kg)	C.B.M.	Size(mm)
Packing	1	20.80	22.40	0.102	930x480x170

**34.507 910x1600x460mm**

	QTY	N.W (kg)	G.W (kg)	C.B.M.	Size(mm)
Packing	1	25.60	27.20	0.102	1250x480x170

**34.508 1220x1600x460mm**

### 5 Shelf

	QTY	N.W (kg)	G.W (kg)	C.B.M.	Size(mm)
Packing	1	21	22.60	0.094	930x480x210

**34.509 610x2180x460mm**

	QTY	N.W (kg)	G.W (kg)	C.B.M.	Size(mm)
Packing	1	27	28.60	0.094	930x480x210

**34.510 910x2180x460mm**

	QTY	N.W (kg)	G.W (kg)	C.B.M.	Size(mm)
Packing	1	31	32.60	0.126	1250x480x210

**34.511 1220x2180x460**



## Promo Shop

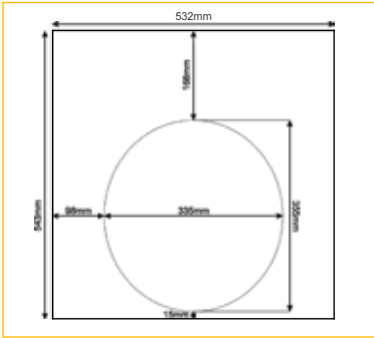

\* Printing



### Setup:

- Place the pieces that will hold the graphic in its place, just like in picture (3).
- Join together part 1 and 2 of the exhibitor.
- If you wish to have a separator to divide the exhibitor in two different compartments. Do it before join together part 1 and 2.
- Place the round piece (disk) on the bottom of the exhibitor.
- Once the last two steps have been performed, place the screws through the holes.
- Place the graphic on its place.
- Place the exhibitor on-top of each other.
- Tighten the screws with the nuts.

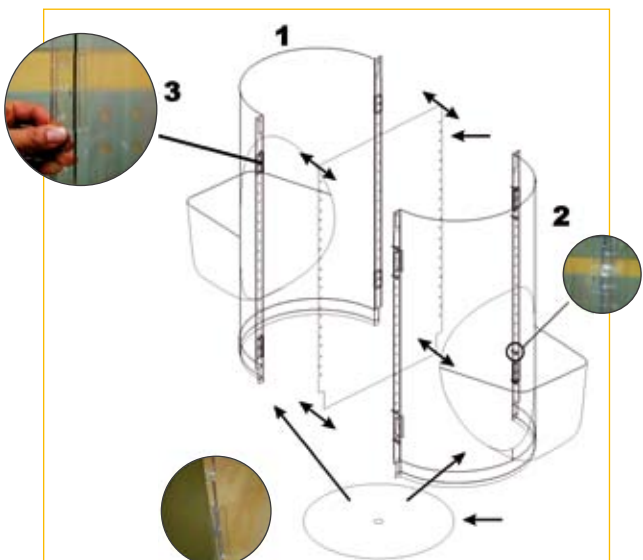

## Promo Shop

Exhibitor made of injected plastic, for the display and introduction of products. Fast and easy to assemble. The plastic screws and assembling pieces for the billboard can be interchange with all display units, depending on the model.

**Material:** Plastic.

	QTY	N.W (kg)
Packing	1	1.1

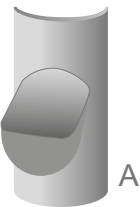

	QTY	N.W (kg)
Packing	1	1



	QTY	N.W (kg)
Packing	1	0.5

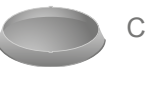

10.108	Promo Shop 1/2	
10.109	Promo Shop - 1	
10.102	Promo Shop - 2	
10.103	Promo Shop - 3	
10.104	Promo Shop - 4	
10.105	Promo Shop - 5	
10.106	Promo Shop - 6	

## Models:

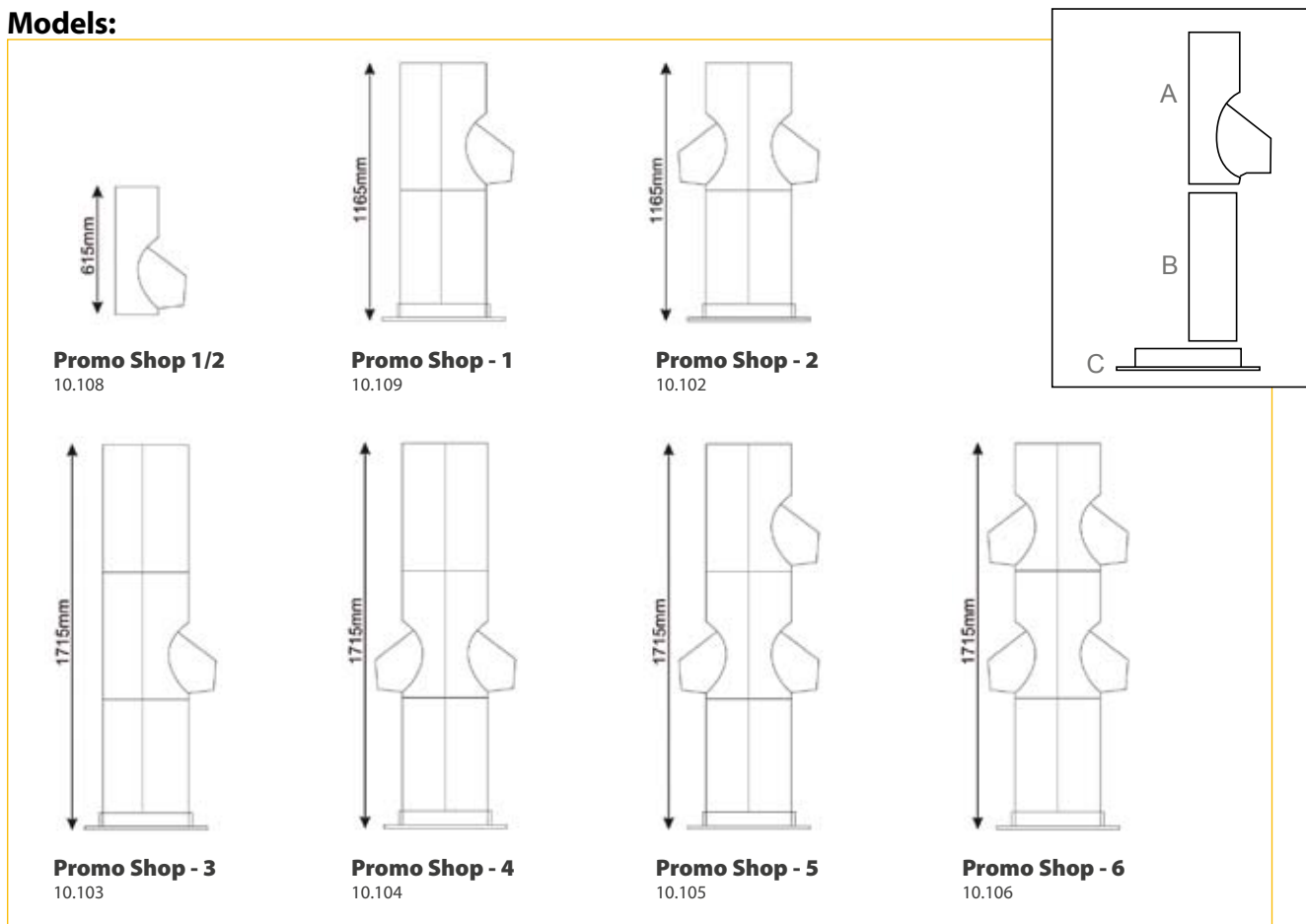

Technical drawings of Promo Shop models with dimensions:

- Promo Shop 1/2 (10.108):** Height 615mm.
- Promo Shop - 1 (10.109):** Height 1165mm.
- Promo Shop - 2 (10.102):** Height 1165mm.
- Promo Shop - 3 (10.103):** Height 1715mm.
- Promo Shop - 4 (10.104):** Height 1715mm.
- Promo Shop - 5 (10.105):** Height 1715mm.
- Promo Shop - 6 (10.106):** Height 1715mm.

Assembly diagram showing components A, B, and C.

# POLE SYSTEM

1

## Samples

1

Ref: 10.839=1 Uni.  
Ref: 10.841=2 Uni.  
Ref: 10.842=2 Uni.

10.839



10.841



10.842



1



2



2

Ref: 10.839=1 Uni.  
Ref: 10.841=4 Uni.  
Ref: 10.842=4 Uni.

3

Ref: 10.839=1 Uni.  
Ref: 10.841=2 Uni.  
Ref: 10.842=2 Uni.  
Ref: 10.843=1 Uni.

10.839



10.841



10.843



10.842



3



4



4

Ref: 10.839=1 Uni.  
Ref: 10.841=1 Uni.  
Ref: 10.843=1 Uni.  
Ref: 10.845=1 Uni.  
Ref: 10.846=1 Uni.  
Ref: 10.847=1 Uni.

5

Ref: 10.839=2 Uni.  
Ref: 10.841=4 Uni.  
Ref: 10.842=2 Uni.  
Ref: 10.848=4 Uni.  
Ref: 10.850=1 Uni.  
Ref: 10.853=1 Uni.  
Ref: 10.856=2 Uni.

10.839



10.849, 10.850, 10.851



10.841



10.852, 10.853, 10.854



10.842



10.856



5



10.848



## Pole system

Exhibition system ideal for P.O.S. Easy and fast to assemble.

**Material:** Steel.

### Extendible Pole

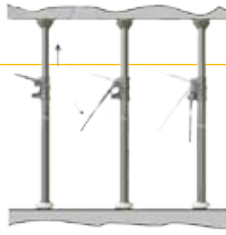

10.839 2100-3700mm

10.840 3100-5600mm

### Display Shelf Connecting Rod.



10.849 1500mm

10.850 1200mm

10.851 900mm

### Roll for Billposter



10.855 300mm

### Poster Spring Clamp



10.842

### Shelf Supporting Clamp



10.848 Ø 45mm

### Post Clamp



10.841 Ø 45mm

### Display Shelf Plate



10.852 1500x380mm

10.853 1200x380mm

10.854 900x380mm

### Supporting Base for Tripod



10.845 900x900mm

10.846 700x700mm

10.847 500x500mm

### Mini Shelf



10.856 290x300

### Tripod



10.843

### Trade Mark Frame



10.844 450x330mm

# TURNTABLES

## 1 Mini Led Moving Message Sign



Mini Led moving message sign. Visible characters. Programmed via buttons on the back. Led colour: red. Battery included.

**Material:** Plastic.

	QTY	N.W (kg)	G.W (kg)	C.B.M.	Size(mm)
Uni.	1	0.02	0.03	0.00006	85x20x35

**10.062**      **79x30x7mm**

## Battery Turning Display



Battery turning display. Load capacity  $\pm$  14 grs. Use 2 battery AA not includes.

**Material:** Plastic.

	QTY	N.W (kg)	G.W (kg)	C.B.M.	Size(mm)
Uni.	1	0.11	0.14	0.0006	165x75x50

**10.063**      **160x70x43mm**

## Solar Turning Display



Solar turning display. Load capacity:  $\pm$  5 grs.

**Material:** Plastic.

	QTY	N.W (kg)	G.W (kg)	C.B.M.	Size(mm)
Uni.	1	0.04	0.05	0.0002	55x105x30

**10.358**      **100x50x30mm**

## Turntable



Solar turning display. Load capacity:  $\pm$  200 grs.

**Material:** Plastic.

	QTY	N.W (kg)	G.W (kg)	C.B.M.	Size(mm)
Uni.	1	0.7	0.1	0.0004	115x85x45

**10.064**      **112x80x43mm**

## Turntable



Led turntable display stand. Includes 4 leds. Battery and electric operated. Load capacity:  $\pm$  5 grs.

**Material:** Steel, plastic parts.

	QTY	N.W (kg)	G.W (kg)	C.B.M.	Size(mm)
Uni.	1	0.3	0.35	0.002	190x75x125

**10.407**      **Ø 80mm x 45mm**

## Turntable



Turntable. Colour: Silver. Plastic flange diameter: 85mm. Load capacity:  $\pm$  200 grs. Use 1 battery AA, not includes.

**Material:** Steel, plastic parts.

	QTY	N.W (kg)	G.W (kg)	C.B.M.	Size(mm)
Uni.	1	0.12	0.15	0.0001	89x95x125

**10.406**      **Ø 85mm x 45mm**



## TextLight

Indoor LED moving sign. All function can be edited by remote control or PC software. 9 kinds of text fonts, different grades display speeds. High precision. Real time & clock. Automatic power on/off. Available in Single or Double line.

Includes:

- Led Display.
- Remote control.
- CD software.
- AC power supply.
- Installation fittings.

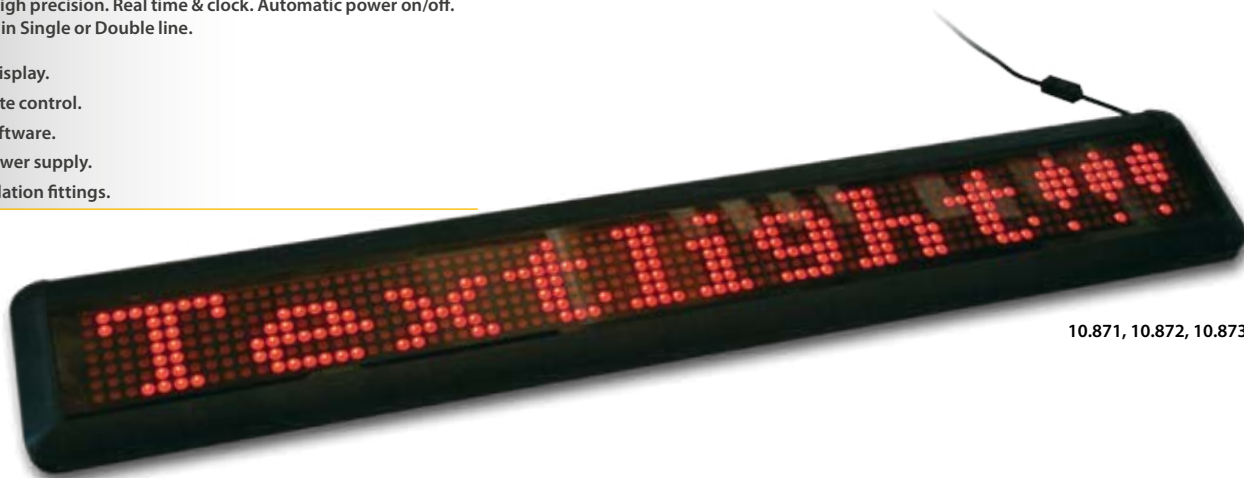

10.871, 10.872, 10.873



10.874, 10.875

	QTY	N.W (kg)	G.W (kg)	C.B.M.	Size(mm)
Packing	1	1.78	2.25	0.01	950x150x80

**10.871**      **65x635mm**

	QTY	N.W (kg)	G.W (kg)	C.B.M.	Size(mm)
Packing	1	2.7	3.45	0.0019	1250x160x95

**10.872**      **65x940mm**

	QTY	N.W (kg)	G.W (kg)	C.B.M.	Size(mm)
Packing	1	3.35	4.2	0.02	1540x170x95

**10.873**      **65x1245mm**

	QTY	N.W (kg)	G.W (kg)	C.B.M.	Size(mm)
Packing	1	4.2	5.2	0.03	1170x235x110

**10.874**      **125x910mm**

	QTY	N.W (kg)	G.W (kg)	C.B.M.	Size(mm)
Packing	1	5.15	6.6	0.04	1470x130x250

**10.875**      **125x1215mm**



## LEDS

Leds. Waterproof 3-diode stripe LED module. Outdoor use.

Applications: Light source of channel letter, back lighting, show window illumination, indoors decoration illumination, building facade Lighting, advertising signboard, neon replacement.

### Antilia

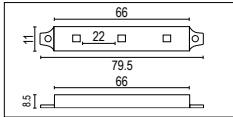

Input-Voltage.	12V
Power.	0.24W
Viewing angle Led.	140°
Units led.	3
Type.	SMD 3528
IP Grade.	IP 66
Working Temp.	-40° / 60°
Aprox. Life.	50.000H

\*With adhesive double sided.

13.222	□	6500K	16 Lm
13.223	■	6190-6350K	3.5 Lm
13.224	■	5120-5280K	9 Lm
13.225	■	4630-4750K	2.8 Lm
13.226	■	5840-5950K	3.2 Lm

Pack 20 Uni.

### Boötes

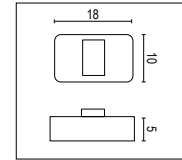

Input-Voltage.	12V
Power.	0.24W
Viewing angle Led.	140°
Units led.	1
Type.	SMD 5050
IP Grade.	IP 66
Working Temp.	-40° / 60°
Aprox. Life.	50.000H

\*With adhesive double sided.

13.227	□	6500K	14 Lm
13.228	■	6190-6350K	7 Lm
13.229	■	5120-5280K	13 Lm
13.230	■	4630-4750K	7 Lm
13.231	■	5840-5950K	7 Lm

Pack 20 Uni.

### Corvus

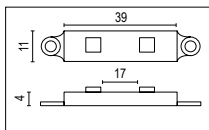

Input-Voltage.	12V
Power.	0.48W
Viewing angle Led.	140°
Units led.	2
Type.	SMD 5050
IP Grade.	IP 66
Working Temp.	-40° / 60°
Aprox. Life.	50.000H

\*With adhesive double sided.

13.232	□	6500K	28 Lm
13.233	■	6190-6350K	11 Lm
13.234	■	5120-5280K	15 Lm
13.235	■	4630-4750K	10 Lm
13.236	■	5840-5950K	10 Lm

Pack 20 Uni.

### Deneb

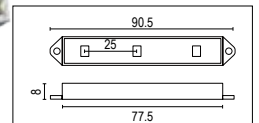

Input-Voltage.	12V
Power.	0.72W
Viewing angle Led.	140°
Units led.	3
Type.	SMD 5050
IP Grade.	IP 66
Working Temp.	-40° / 60°
Aprox. Life.	50.000H

\*With adhesive double sided.

13.237	□	6500K	38 Lm
13.238	■	6190-6350K	16 Lm
13.239	■	5120-5280K	20 Lm
13.240	■	4630-4750K	15 Lm
13.241	■	5840-5950K	15 Lm

Pack 20 Uni.

### Eridanus

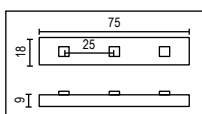

Input-Voltage.	12V
Power.	0.72W
Viewing angle Led.	140°
Units led.	3
Type.	SMD 5050
IP Grade.	IP 66
Working Temp.	-40° / 60°
Aprox. Life.	50.000H

\*With adhesive double sided.

13.242	■	RGB	
--------	---	-----	--

Pack 20 Uni.

### Lepus

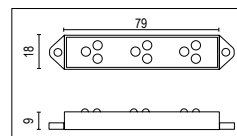
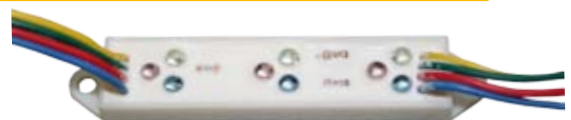

Input-Voltage.	12V
Power.	0.72W
Viewing angle Led.	90°
Units led.	9
Type.	3R3G3B
IP Grade.	IP 66
Working Temp.	-40° / 60°
Aprox. Life.	50.000H

\*With adhesive double sided.

13.245	■	RGB	
--------	---	-----	--

Pack 20 Uni.

## Orionis

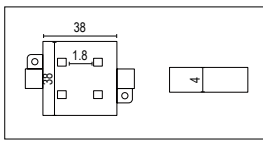

Input-Voltage.	12V
Power.	0.96W
Viewing angle Led.	140°
Units led.	4
Type.	SMD 5050
IP Grade.	IP 66
Working Temp.	-40° / 60°
Aprox. Life.	50.000H

\*With adhesive double sided.

<b>13.248</b>	<input type="checkbox"/>	6500K	40 Lm
<b>13.249</b>	<input checked="" type="checkbox"/>	6190-6350K	21 Lm
<b>13.250</b>	<input checked="" type="checkbox"/>	5120-5280K	28 Lm
<b>13.251</b>	<input checked="" type="checkbox"/>	4630-4750K	20 Lm
<b>13.252</b>	<input checked="" type="checkbox"/>	5840-5950K	20 Lm

Pack 60 Uni.

## Perseus

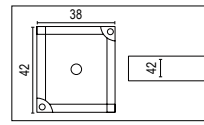

Input-Voltage.	12V
Power.	1W
Viewing angle Led.	140°
Units led.	1
Type.	1W
IP Grade.	IP 66
Working Temp.	-40° / 60°
Aprox. Life.	50.000H

\*With adhesive double sided.

<b>13.253</b>	<input type="checkbox"/>	6500K	110 Lm
<b>13.254</b>	<input checked="" type="checkbox"/>	6190-6350K	40 Lm
<b>13.255</b>	<input checked="" type="checkbox"/>	5120-5280K	65 Lm
<b>13.256</b>	<input checked="" type="checkbox"/>	4630-4750K	25 Lm
<b>13.257</b>	<input checked="" type="checkbox"/>	5840-5950K	40 Lm

Pack 30 Uni.

## Sagitta

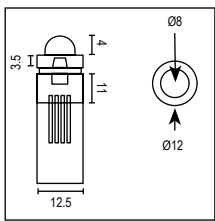

Input-Voltage.	5V
Power.	0.3W
Viewing angle Led.	120°
Units led.	1
Type.	8mm RGB LED
IP Grade.	IP 66
Working Temp.	-40° / 60°
Aprox. Life.	50.000H

\*With adhesive double sided.

<b>13.258</b>	<input checked="" type="checkbox"/>	RGB
---------------	-------------------------------------	-----

Pack 50 Uni.

## Serpens

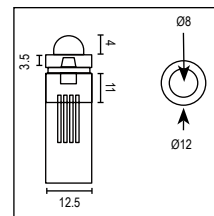

Input-Voltage.	5V
Power.	0.1W
Viewing angle Led.	90°
Units led.	1
Type.	8mm LED
IP Grade.	IP 66
Working Temp.	-40° / 60°
Aprox. Life.	50.000H

\*With adhesive double sided.

<b>13.259</b>	<input type="checkbox"/>
<b>13.260</b>	<input checked="" type="checkbox"/>
<b>13.261</b>	<input checked="" type="checkbox"/>
<b>13.262</b>	<input checked="" type="checkbox"/>
<b>13.263</b>	<input checked="" type="checkbox"/>

Pack 50 Uni.

## Hydra



Input-Voltage.	12V
Power.	150 LEDs 24W 300 LEDs 30-36W
Viewing angle Led.	120°
Type.	13.277 SMD 3528 13.278 SMD 5050 13.279 SMD 5050
IP Grade.	IP 65
Working Temp.	120°
Aprox. Life.	50.000H

\*With adhesive double sided.

<b>13.277</b>	<input type="checkbox"/>	300 LEDs	White	Roll 5m.	
<b>13.278</b>	<input type="checkbox"/>	150 LEDs	White		
<b>13.279</b>	<input checked="" type="checkbox"/>	150 LEDs	RGB	Roll 5m.	

## Orion



Input-Voltage.	12V
Power.	150 LEDs 30-36W 300 LEDs 60-72W
Viewing angle Led.	120°
Type.	13.274-13.278 SMD 5050 13.279 SMD 5060
IP Grade.	IP 65
Working Temp.	120°
Aprox. Life.	50.000H

\*With adhesive double sided.

<b>13.274</b>	<input type="checkbox"/>	150 LEDs	White	Roll 5m.	
<b>13.275</b>	<input type="checkbox"/>	300 LEDs	White		
<b>13.276</b>	<input checked="" type="checkbox"/>	300 LEDs	RGB	Roll 5m.	

### \*Connector RGB

<b>13.247</b>	100mm	RGB	
---------------	-------	-----	--

### \*Connector monocrome

<b>13.280</b>	100mm		
---------------	-------	--	--

## Sextans / Kamal

RF controller adopts the advanced micro control unit, it is used for controlling a variety of lamp whose source of light is LED. For instance, point source of light, flexible light strip, wall washer lamp, etc.



Input-Voltage.	5-24V
Output power.	60-288W
MAX Output current.	4A
Control Distance.	10-15m
Dimensions (LxWxH)	130x65x24mm
Weight.	165g



13.273

Sextans

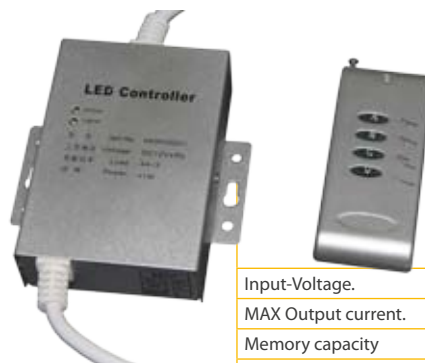

Input-Voltage.	12V
MAX Output current.	4-6A
Memory capacity	16 Kb
Control Distance.	30-50 m
Dimensions (LxWxH)	95x89x26mm
Weight.	250g



13.281

Kamal

## Convers

### Pegasus



Input-Voltage.	110-250V
Output-Voltage.	12V
Power.	15W
Output current.	1.25A
Installation.	Waterproof IP66
Cooling.	Free air convection
Dimensions (LxWxH)	180x30x20mm
Weight.	0.18Kg



13.264

### Grus



Input-Voltage.	170-250V
Output-Voltage.	12V
Power.	30W
Output current.	2.5A
Installation.	Waterproof IP66
Cooling.	Free air convection
Dimensions (LxWxH)	220x30x20mm
Weight.	0.25Kg



13.265

### Centaurus



Input-Voltage.	170-250V
Output-Voltage.	12V
Power.	60W
Output current.	5A
Installation.	Waterproof IP66
Cooling.	Free air convection
Dimensions (LxWxH)	180x67x50mm
Weight.	0.8Kg



13.266

### Cassiopea



Input-Voltage.	170-250V
Output-Voltage.	12V
Power.	100W
Output current.	8.3 A
Installation.	Waterproof IP66
Cooling.	Free air convection
Dimensions (LxWxH)	243x67x50mm
Weight.	0.9Kg



13.267

## Ursa



Input-Voltage.	110-250V
Output-Voltage.	12V
Power.	150W
Output current.	12.5 A
Installation.	Waterproof IP66
Cooling.	Free air convection
Dimensions (LxWxH)	211x134x70mm
Weight.	2.36Kg



13.268

## Tucana



Output-Voltage.	DC 350mA 4-12V
Rate loading.	1-3x3W
Installation.	Indoor
Dimensions (LxWxH)	46x26x20mm
Weight.	0.1Kg



13.269

## Tigris



Output-Voltage.	DC 350mA 12-24V
Rate loading.	4-6x1W
Installation.	Indoor
Dimensions (LxWxH)	Ø49x22mm
Weight.	0.1Kg



13.270

## Volans



Input-Voltage.	170-250V
Output-Voltage.	5V DC
Power.	30W
Output current.	5 A
Installation.	Waterproof IP66
Cooling.	Free air convection
Dimensions (LxWxH)	180x67x50mm
Weight.	0.8Kg



13.271

## Lynx



Input-Voltage.	170-250V
Output-Voltage.	5V DC
Power.	60W
Output current.	5A
Installation.	Waterproof IP66
Cooling.	Free air convection
Dimensions (LxWxH)	180x67x50mm
Weight.	0.8Kg



13.272

## Relationship - LEDs / Power supply

		Power supply								
		Pegasus	Grus	Centaurus	Cassiopeia	Ursa	Tucana	Tigris	Volans	Lynx
LEDs	Antilia	±50	±100	±200	±333	±500	±10	±20		
	Boötes	±50	±100	±200	±333	±500	±10	±20		
	Corvus	±25	±50	±100	±167	±250	±5	±10		
	Deneb	±17	±34	±68	±111	±167	±3	±7		
	Eridanus	±17	±34	±68	±111	±167	±3	±7		
	Lepus	±17	±34	±68	±111	±167	±3	±7		
	Orionis	±13	±26	±52	±83	±125	±2	±5		
	Perseus	±12	±24	±48	±80	±120	±2	±5		
	Sagitta								±80	±160
	Serpens								±240	±480

\*LEDs units.

# BICYCLES STAND

1

## Carlow

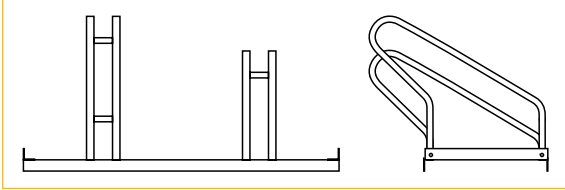

Sturdy frame with robust wheel holders. Designed so they can be joined together and fixed to the ground. Galvanised finish so weatherproof and resistant to corrosion.

**Material:** Galvanised steel.

10.705	700mm	2 Places.	<input type="text"/>
10.706	1050mm	3 Places.	<input type="text"/>
10.762	1750mm	5 Places.	<input type="text"/>
10.782	2100mm	6 Places.	<input type="text"/>
10.933	2450mm	7 Places.	<input type="text"/>



## Wexford



Bicycles stand. Galvanised coating protects against corrosion. With 2 x A1 landscape silver anodised aluminium click frames double sided.

**Material:** Galvanised steel.

10.809	A1	<input type="text"/>	
--------	----	----------------------	--





## Standard Flags System

Flags made in high quality polyester. Outdoor & indoor.

**Material:** Polyester 120 gr.

**\* C.E Flags**

10.379	700x1000mm	<input type="checkbox"/>
10.882	1500x1000mm	<input type="checkbox"/>
10.883	2000x1200mm	<input type="checkbox"/>
10.884	2500x1500mm	<input type="checkbox"/>

Textile pattern n°: 1

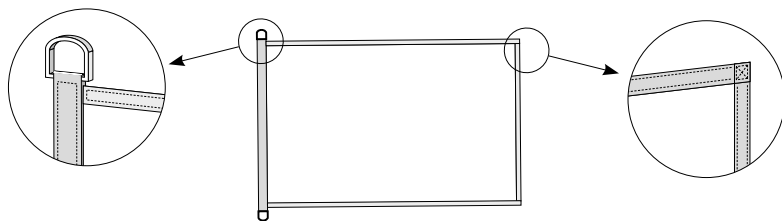

Austria	Belgium	Bulgaria	Cyprus	Czech Republic	Denmark
Estonia	Finland	France	Germany	Greece	Hungary
Ireland	Italy	Latvia	Lithuania	Luxembourg	Malta
Netherlands	Poland	Portugal	Romania	Slovakia	Slovenia
Spain	Sweden	United Kingdom			



C.E

## Request Flags System

Flags made in high quality polyester. Outdoor & indoor.  
Price as request according to the printing.

**Material:** Polyester 120 gr.



Afghanistan      Albania      Algeria



Andorra      Antigua and Barbuda      Argentina



Armenia      Australia      Bahrain



Barbados



Bhutan



Brazil



Brunei



Burkina Faso



Burundi



Cambodia



Cameroon



Canada



Cape Verde



Central African Rep.



Chad



Chile



Colombia



Comoros



Cuba



Djibouti



Dominica



Dominican Rep.



East Timor



Ecuador



Egypt



El Salvador



Equatorial Guinea



Eritrea

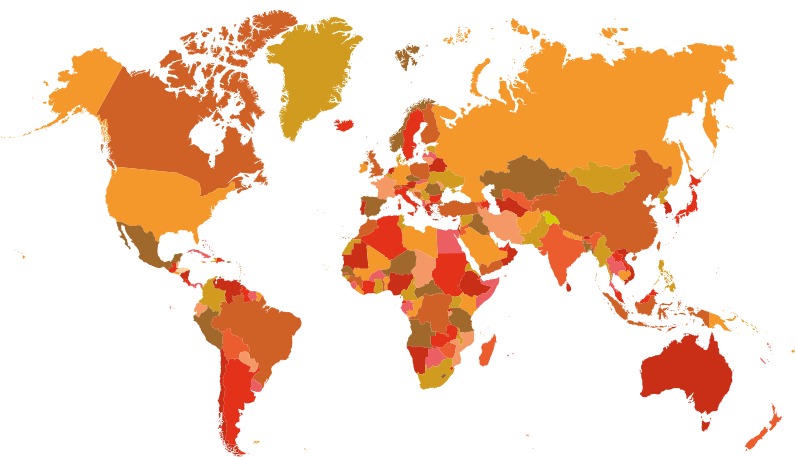

Ethiopia



Fiji



Gabon



Gambia



Guatemala



Guinea



Guyana



Haiti



Honduras



Jamaica

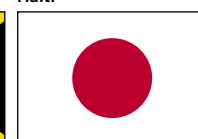

Japan



Jordan



Indonesia



Iran



Isle of Man





## Request Flags System



## Internationals

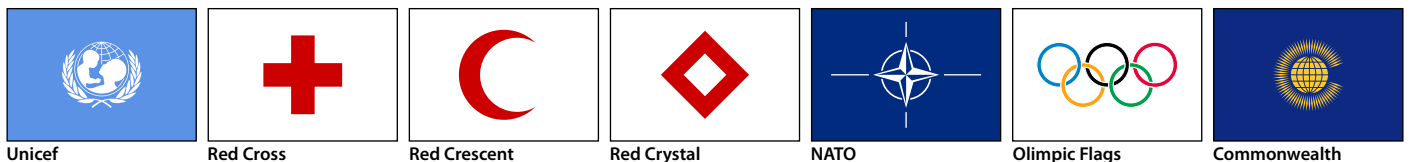

## Enterprises



## Universities

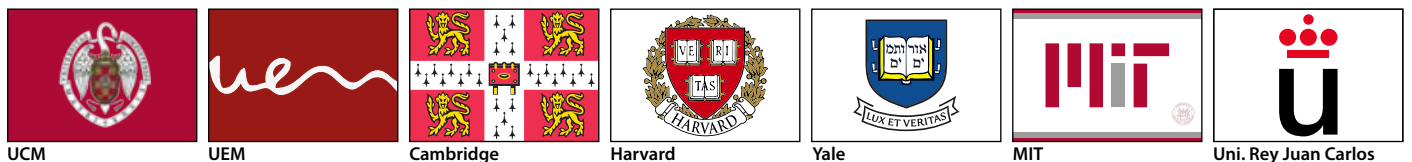

## Sports

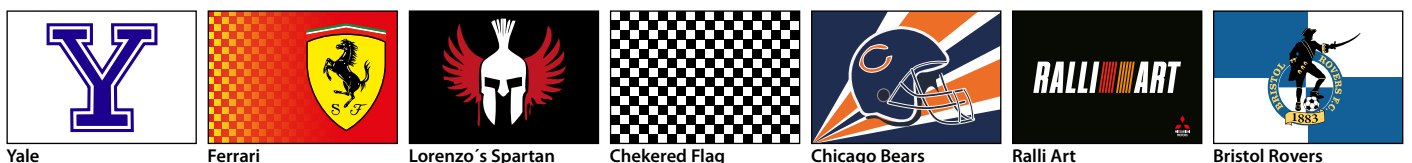

Check our website [www.cashdisplay.com](http://www.cashdisplay.com) for more models or customized printing flags.

## Technical features

Flags made in high quality polyester, printing on textile and finishing thermal. Outdoor & indoor.

**Material:** Polyester 120 gr.

- 1 Reinforcing strip and rings type "D".
- 2 Reinforcing strip and muskets.
- 3 Reinforcing strip and eyelets.
- 4 Reinforcing strip and rope with ring.
- 5 Rod pod.
- 6 sheath, tape binding and eyelet.
- 7 Triangular flags with reinforcing strip and rings type "D"

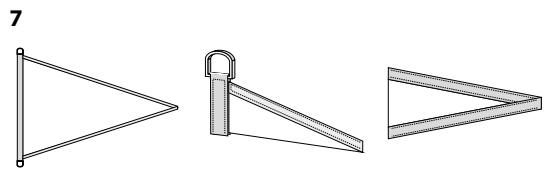
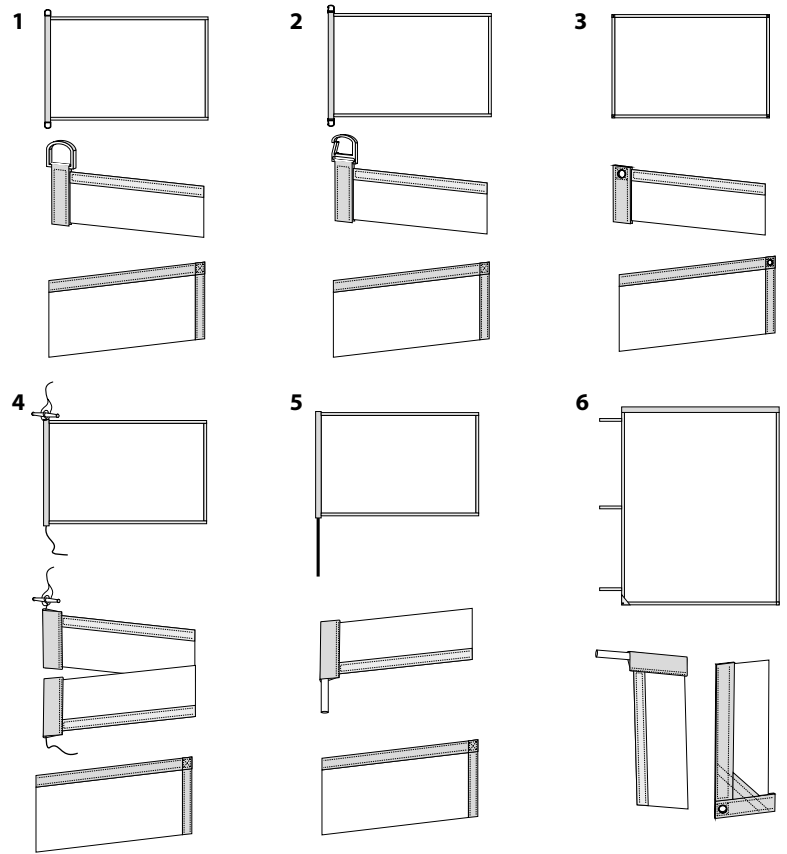

## Lamp System

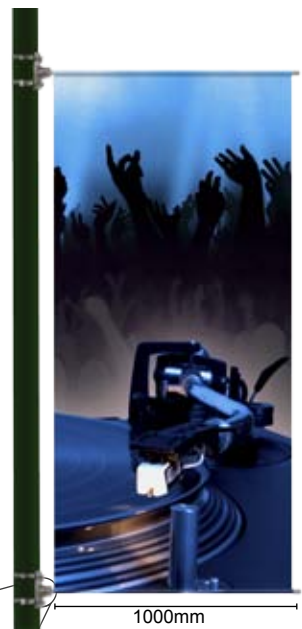

Banner flag system for lamp or another outdoor post. This support is designed for stronger wind conditions. Each kit includes:

- 1 aluminium bracket.
- 1 pin and 1 ring.
- 2 stainless steel band.
- 1 fiberglass pole 1000mm. length.

**Material:** Aluminium, plastic parts.

	QTY	N.W(kg)	G.W(kg)	C.B.M.	Size(mm)
Uni.	1	1	1.35	0.006	1010x100x65

12.353

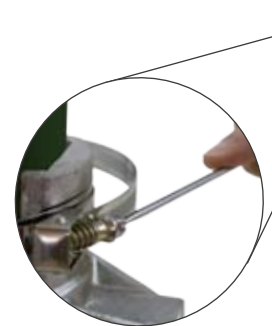

## Pole System

7m

Anchoring floor with pole system. Includes all accessories.

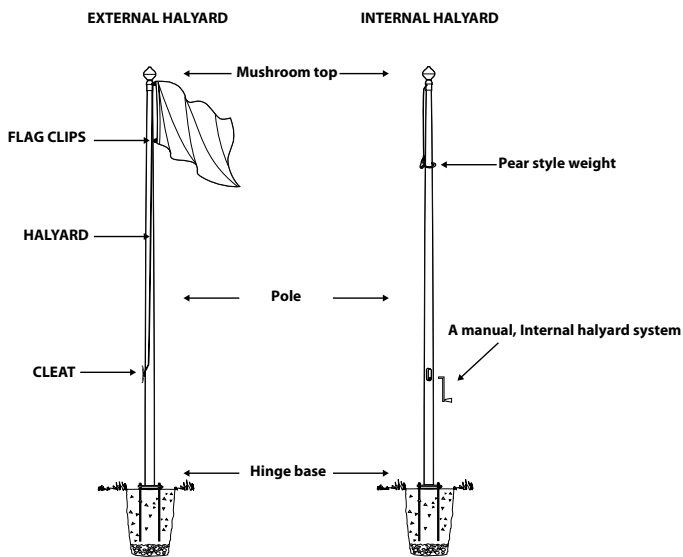

Total length	7000mm.
Total weight	17 Kg.
Total thickness bottom	29mm.
Total thickness top	23mm.
OD bottom	11mm.
OD top	65mm.

### External Halyard Pole



### Internal Halyard Pole

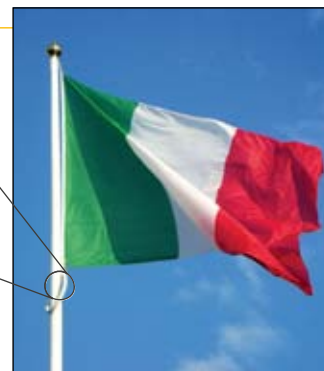
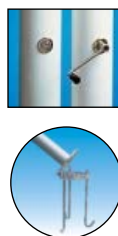

10.249 7000mm

10.758 7000mm

## Banner Arm System

7m

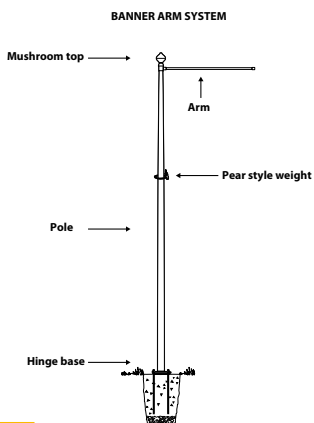
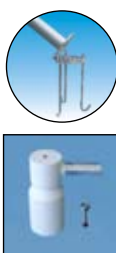

10.773 7000mm

## Car & Bike System Flag



Flag system for attaching to both cars and bikes.

**Material:** Plastic.

10.514	450mm	300x450mm	<input type="text"/>
10.515	500mm	300x450mm	<input type="text"/>
10.516	550mm	300x450mm	<input type="text"/>
10.517	300mm	200x300mm	<input type="text"/>

\*with bracket

\*Printing



## Indoor Pole System

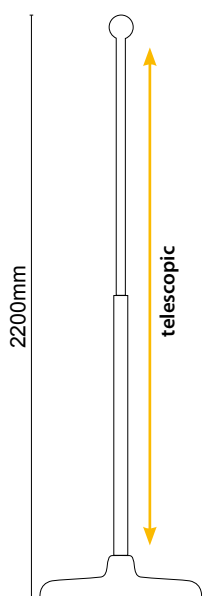

10.718

10.711

Telescopic aluminium flagpole with base.

**Material:** Aluminium.

10.711	Silver	<input type="text"/>	
10.718	Gold	<input type="text"/>	



## Wall Pole

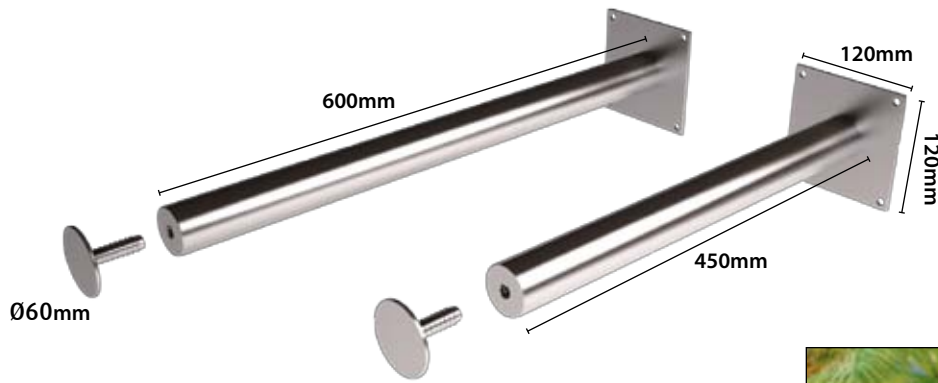

Stainless steel anchoring wall system.

**Material:** Stainless steel.

10.453	Ø40x450mm	
10.454	Ø40x600mm	

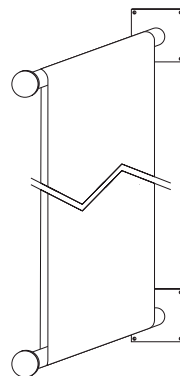

## Holder



Anchoring wall system.

**Material:** Aluminium or Nylon.

10.901	Ø 25.4mm	
10.902	Ø 28mm	
10.906	Ø 19mm	
10.985	Ø 25.4mm	



2



exhibitions solutions

## Panel Banner Vidago

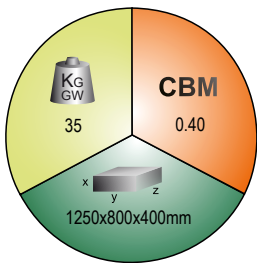

Magnetic Panel System. Using straight frames to which graphic panel can be attached by means of magnetic strips.

**Components:**

- 2 steel round base.
- 2 aluminum pole.
- 4 aluminum case (700x1000mm).
- 2 lights.
- 8 pcs PS panel.
- Connectors.

**Material:** Aluminium, plastic parts.



10.430

2100x2000mm





## Rennes

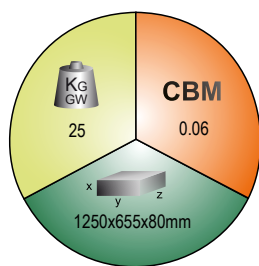
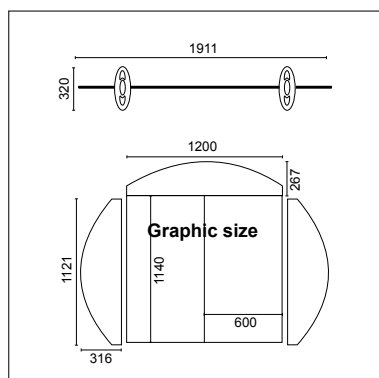

Exhibition table top system smart and stable. This system use form of pictorial graphic, legerity look, simple estructure and easy to install. The system can be use in presentations, marketing events and shows. Printing it's not includes.

**Includes:**

- Aluminium frame 1200x1140mm.
- Header board.
- Wings (2 units)-(L&R).
- Spotlights (2 units).
- Packing in carton box.

**Material:** Aluminium.

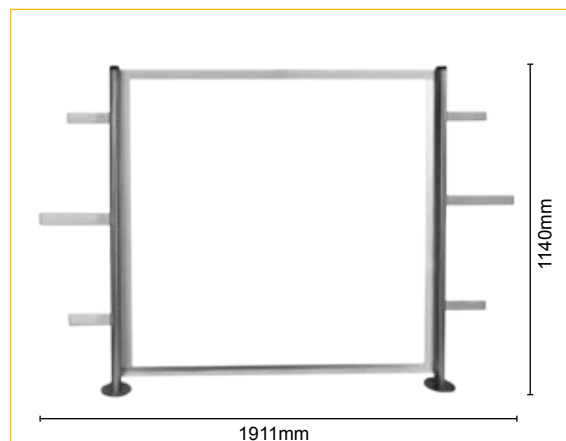

10.107

1911x1407mm



## Catania

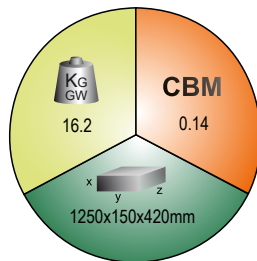
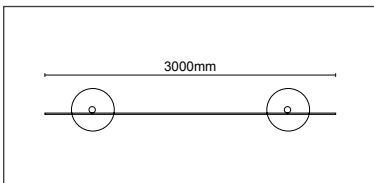
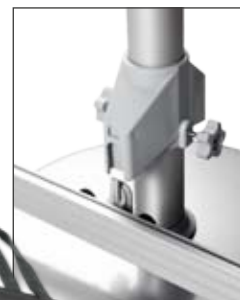

Portable Display Wall. The framework is made of aluminium. The construction makes it easy and fast to assemble. The system can be used in presentations, marketing events and shows. Printing and graphics it's not included.

Includes:

- Aluminium Profile, Base feet and two spotlight.
- Oxford Cloth bag: 1 unit.

**Material:** Aluminium, plastic parts.

10.647

3000x2000mm



## Perugia

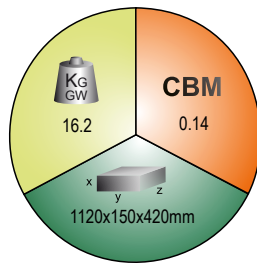
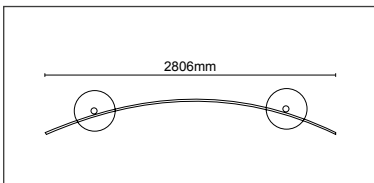
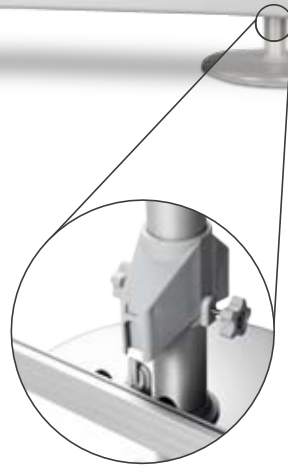

Portable display wall. The framework is made of aluminium. The construction makes it easy and fast to assemble. The system can be used in presentations, marketing events and shows. Printing and graphics it's not includes.

Includes:

- Aluminium profile, Base feet and two spotlight.
- Oxford Cloth bag: 1 unit.

**Material:** Aluminium, plastic parts.

10.648

3000x2000mm



## Rimini

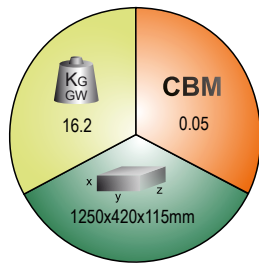
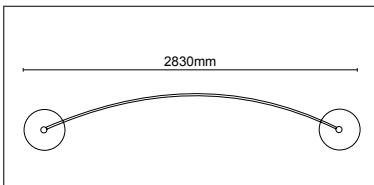

Portable Display Wall. The framework is made of aluminium. The construction makes it easy and fast to assemble. The system can be used in presentations, marketing events and shows. Printing and graphics it's not included.

**Includes:**

- Aluminium Profile, Base feet, brochure holder and two spotlight.
- Wheeled case: 1 unit.

**Material:** Aluminium, plastic parts.



10.649

2135x738mm x3



## Limoges

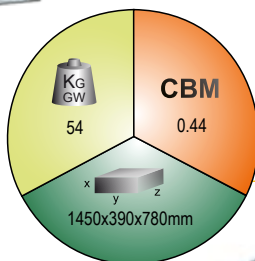
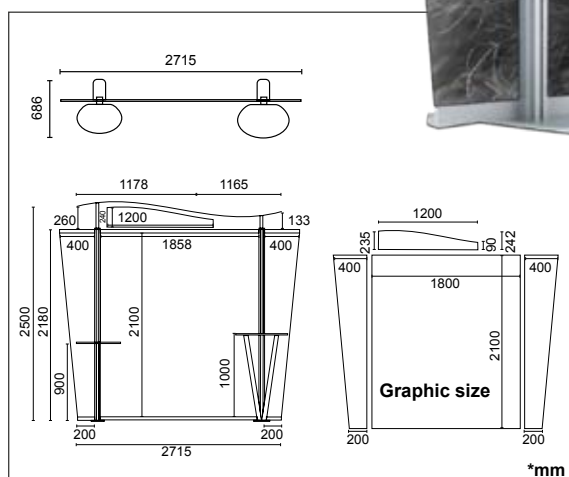

Exhibition system smart and stable. The system can be use in presentations, marketing events and shows. Easy to install. Printing it's not includes.

Includes:

- Aluminium frame 2000x2200mm.
- Header Board.
- Wings (2 units) (L&R).
- Shelves: 1
- "V" Shape Table: 1.
- Spotlights (2 units).
- Plastic Packing Case.

**Material:** Aluminium, plastic parts.

10.153



## Opole

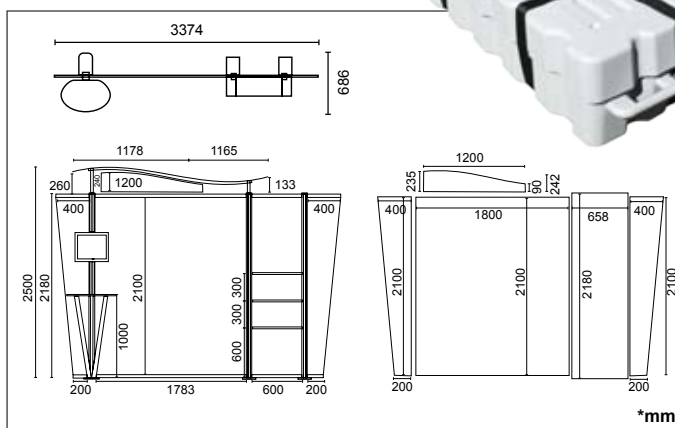
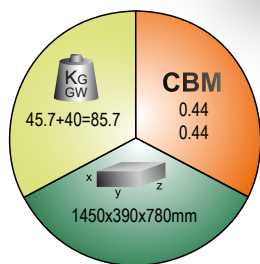

Exhibition system smart and stable. The system can be use in presentations, marketing events and shows. Easy to install. Printing it's not includes. TV not includes.

Includes:

- Aluminium frame 2850x2200mm.
- Header Board.
- Wings (2 units) (L&R).
- Shelves: 3.
- "V" Shape Table: 1.
- Spotlights (3 units).
- LCD fixer.
- Plastic Packing Case: 1.

**Material:** Aluminium, plastic parts.

10.192



\*TV not included

## Kassel

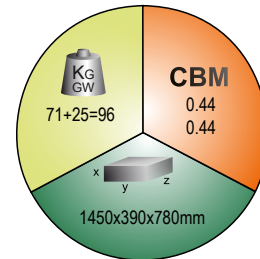

Exhibition system smart and stable. The system can be use in presentations, marketing events and shows. Easy to install. Printing and graphics it's not includes.

Includes:

- Aluminium frame 2824x2400mm.
- Counter.
- Header Board.
- Shelves: 3.
- Spotlights (3 units).
- Plastic Packing Case: 1 units.

**Material:** Aluminium, plastic parts.

10.364

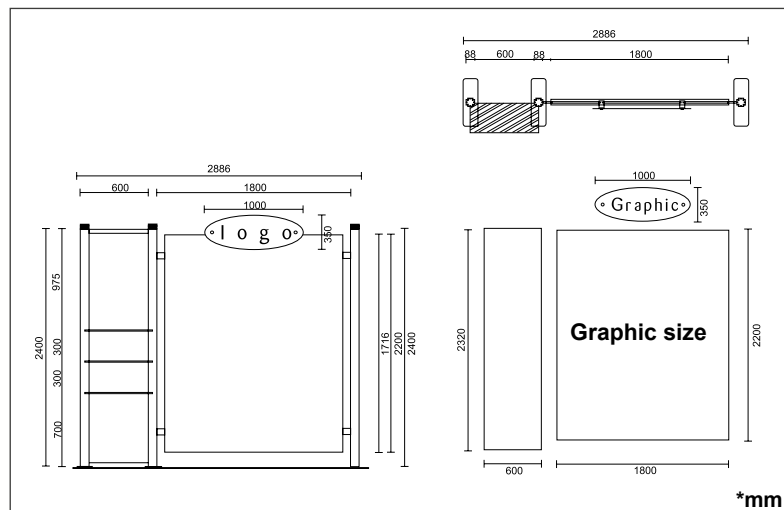

**Brescia**

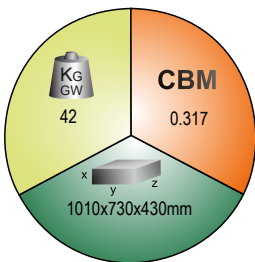

Flexible Pop Up wall system. The framework is made of aluminium. The construction makes it easy and fast to assemble. The system can be use in presentations, marketing events and shows. Printing and graphics it's not includes.

Includes:

- Pop Up Frame 3x1 straight x 3 sets.
- Corner accesiores: 3.
- Plastic Packing Case: 1 unit.

**Material:** Aluminium, plastic parts.

**10.415**

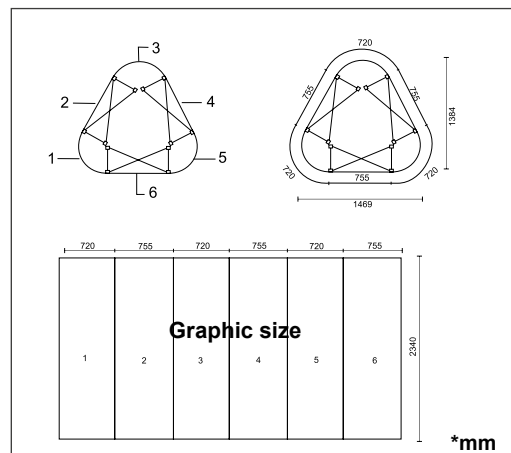



## Siena

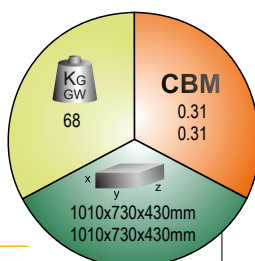

Flexible Pop Up wall system. The framework is made of aluminium. The construction makes it easy and fast to assemble. The system can be use in presentations, marketing events and shows. Printing and graphics it's not includes.

Includes:

- Pop Up Frame 3x3 curve x 2 sets.
- Spotlights: 4 units.
- Plastic Packing Case: 2 units.

**Material:** Aluminium, plastic parts.

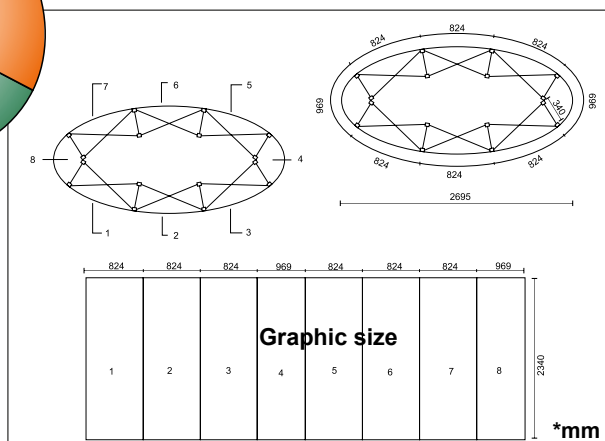

10.640



## Pescara

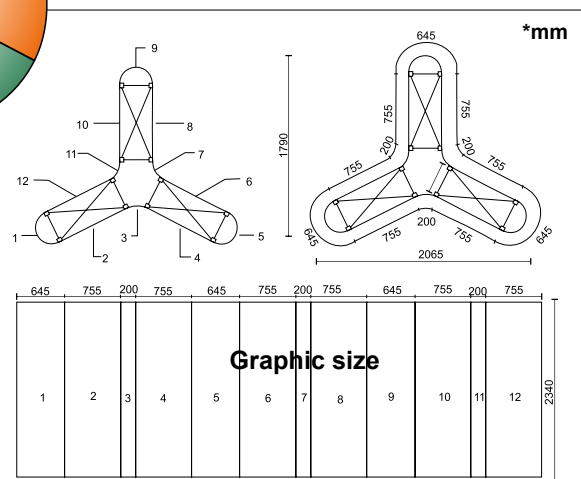
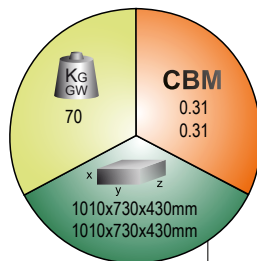
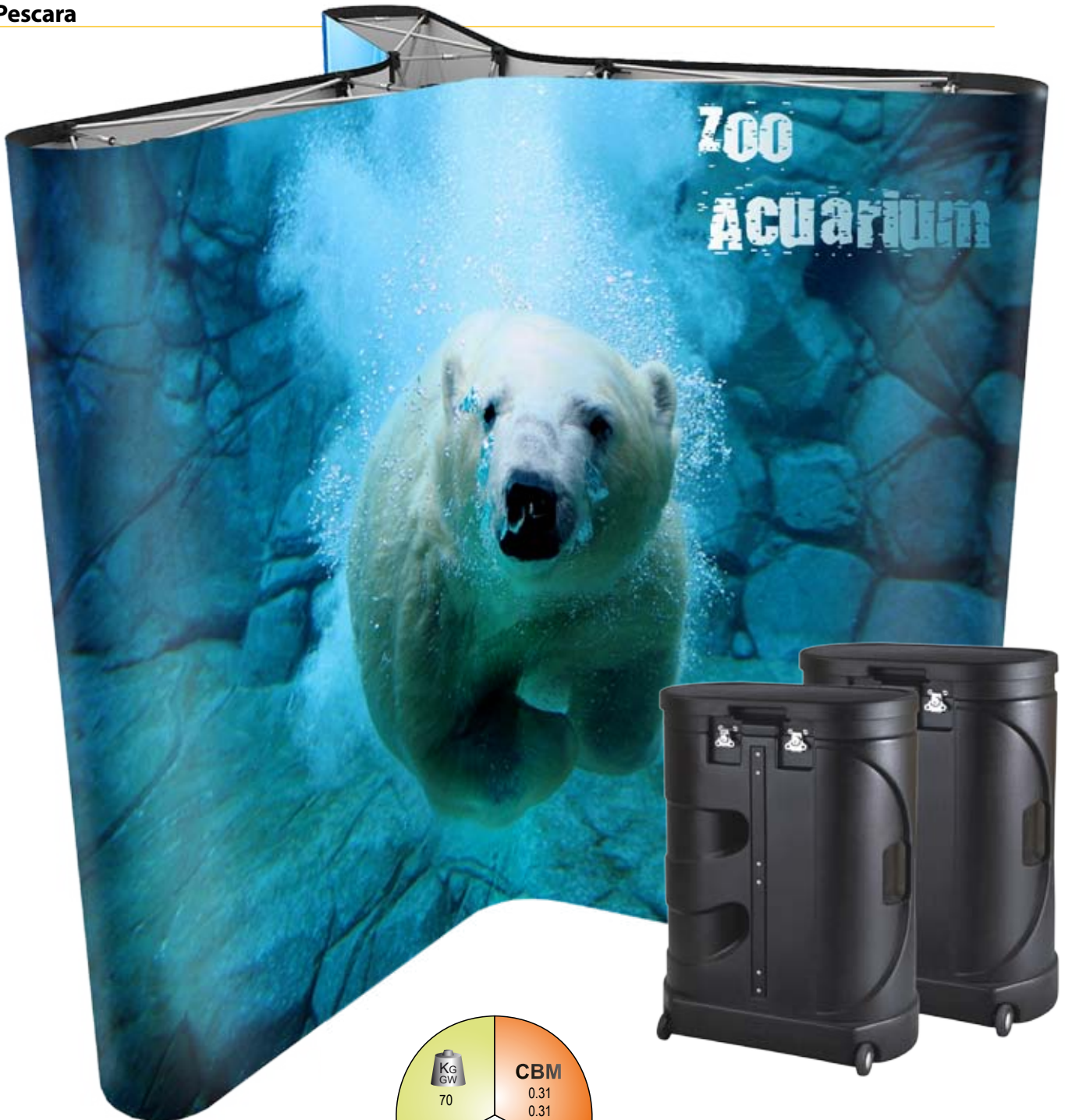

Flexible Pop Up wall system. The framework is made of aluminium. The construction makes it easy and fast to assemble. The system can be use in presentations, marketing events and shows. Printing and graphics it's not includes.

Includes:

- Pop Up Frame 3x1 straight x 3 sets.
- Corner accesiores: 3.
- Plastic Packing Case: 2 units.

**Material:** Aluminium, plastic parts.

10.639



## Pop-Up Teide 8x3 "S"

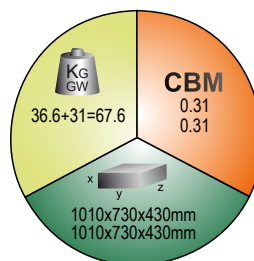
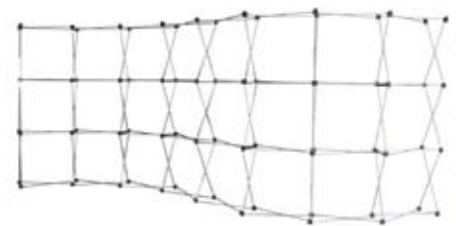
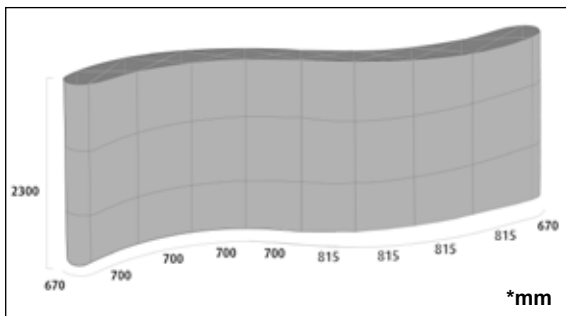

Flexible pop-up with structure in "S", double sided. The framework is made of aluminium. The construction makes it easy and fast to assemble the panels with graphics.

Includes:

- 2 Hard Trolley carry bag.
- Magnetic Strip Roll.
- Hangers / Magnetics bars.
- 4 Spot Light.

**Material:** Aluminium, plastic parts.

10.234



## Trento

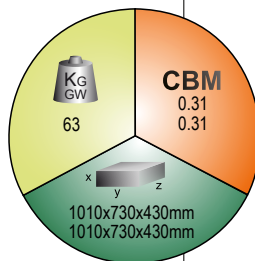
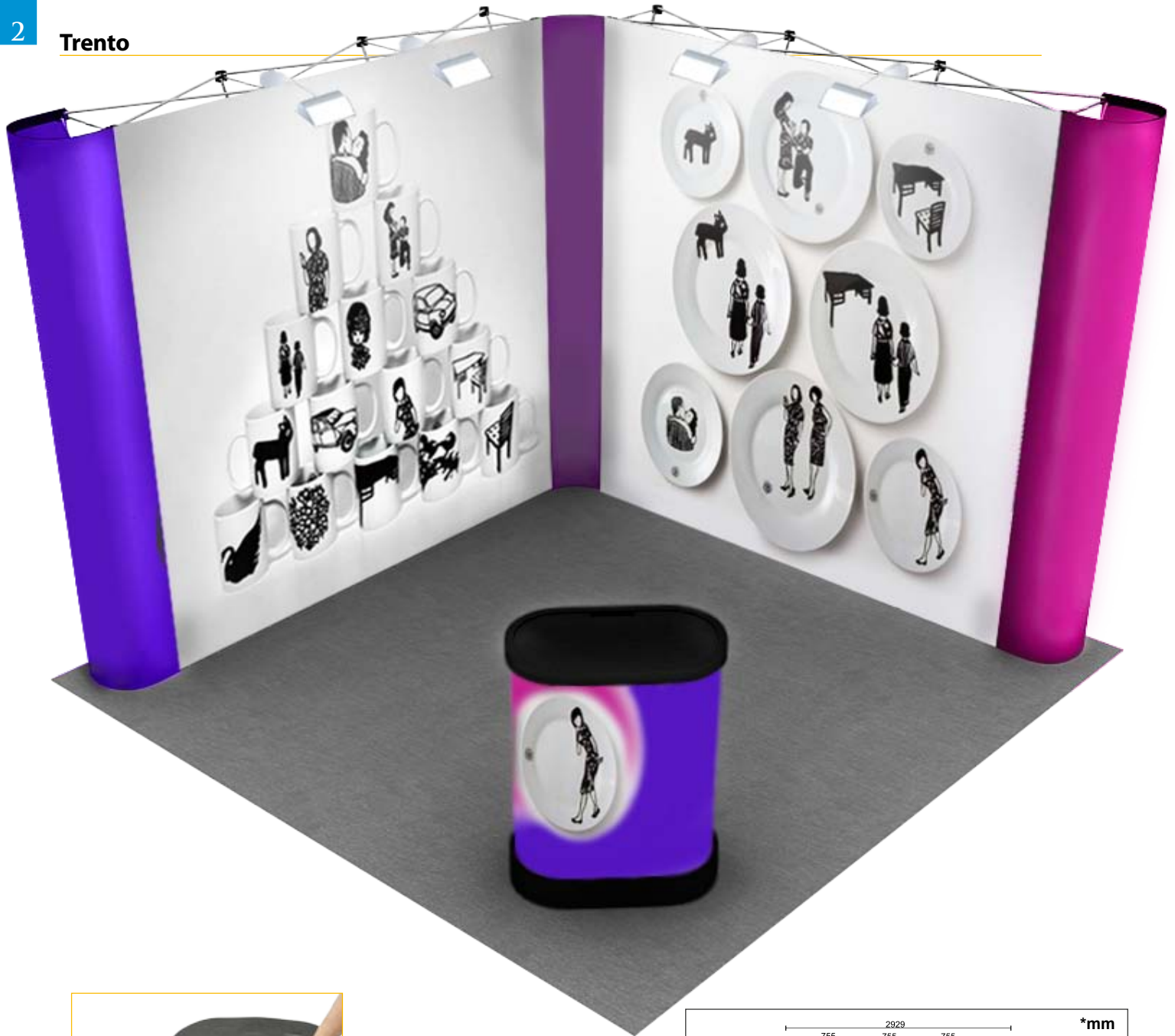

Flexible Pop Up wall system. The framework is made of aluminium. The construction makes it easy and fast to assemble. The system can be use in presentations, marketing events and shows. Printing and graphics it's not includes.

Includes:

- Pop Up Frame 3x3 straight x 2 sets.
- Corner accesiores: 1 set.
- Spotlights: 4 units.
- Plastic Packing Case: 2 units.

**Material:** Aluminium, plastic parts.

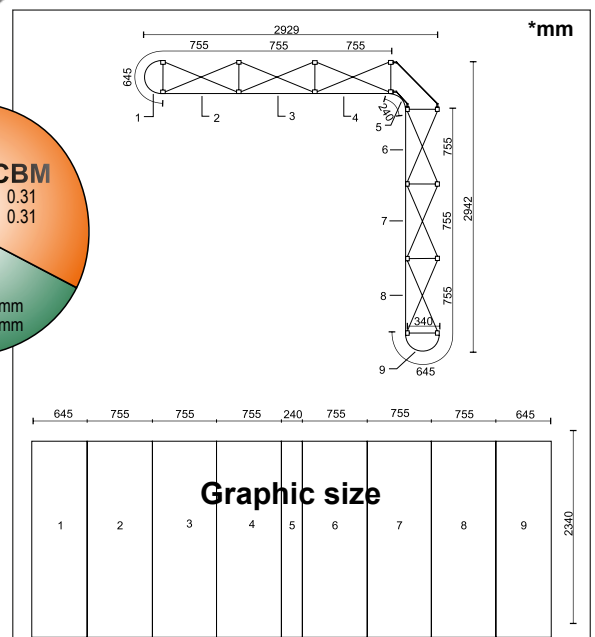

10.642



## Milán

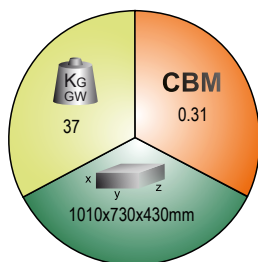

Flexible Pop Up wall system. The framework is made of aluminium. The construction makes it easy and fast to assemble. The system can be use in presentations, marketing events and shows. Printing and graphics it's not includes.

Includes:

- Pop Up Frame 4x3 straight.
- Plastic Packing Case: 1 unit.

**Material:** Aluminium, plastic parts.

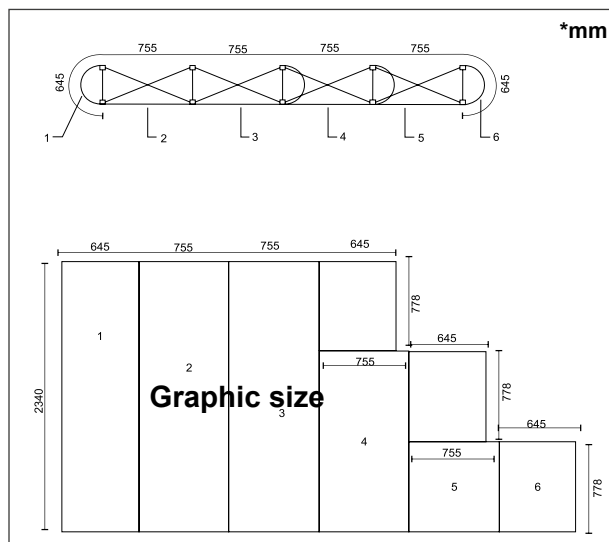

10.646



## Venecia

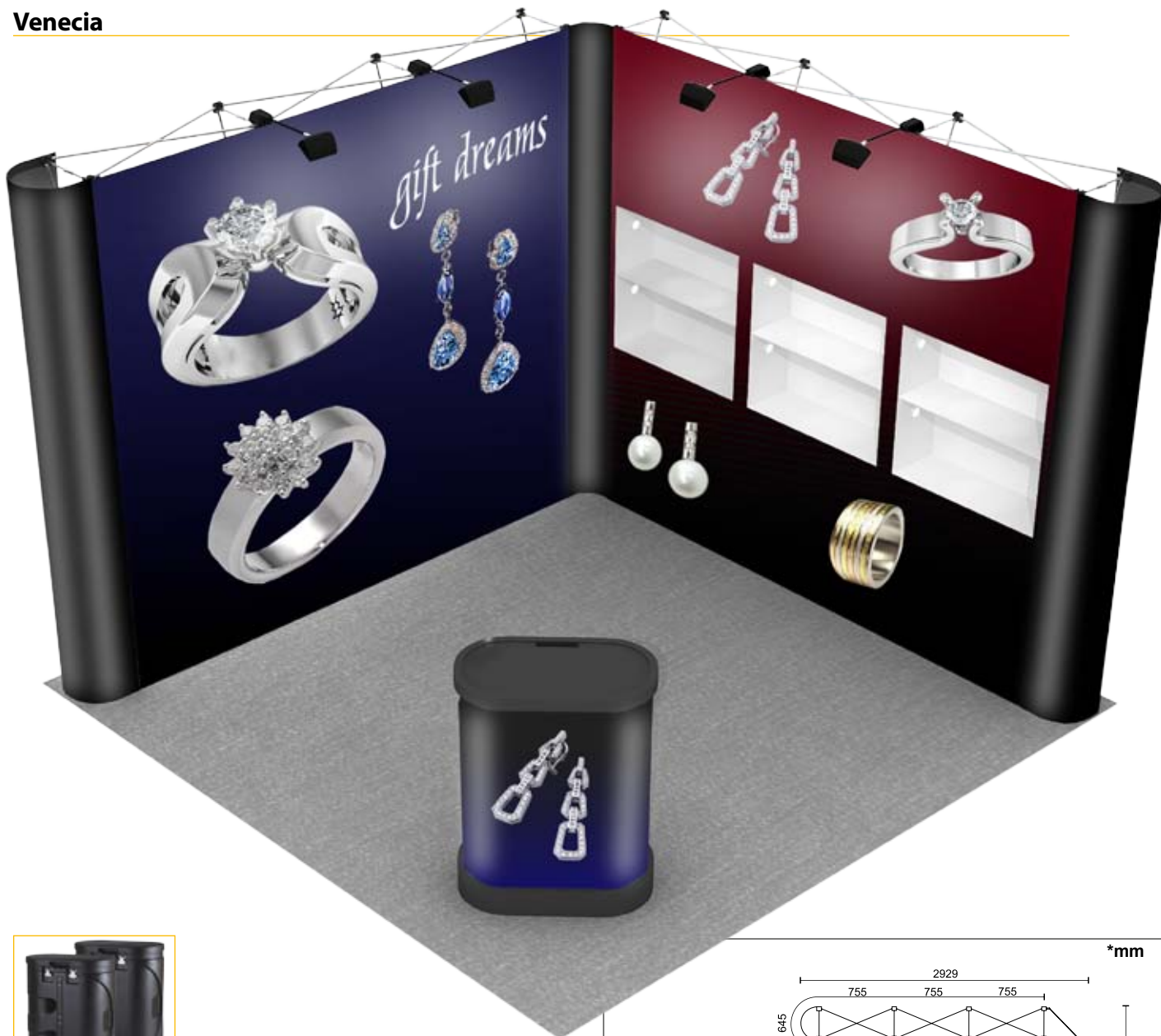

Flexible Pop Up wall system. The framework is made of aluminium. The construction makes it easy and fast to assemble. The system can be use in presentations, marketing events and shows. Printing and graphics it's not includes.

**Includes:**

- Pop Up Frame 3x3 straight x 2 sets.
- Pop Up Show Window x 3 sets.
- Corner accessoires: 2 set.
- Spotlights: 4 units.
- Plastic Packing Case: 2 units.

**Material:** Aluminium, plastic parts.

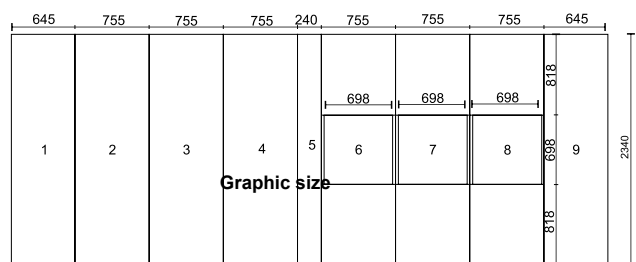
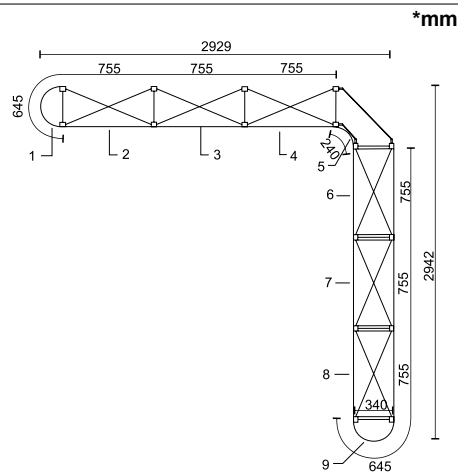
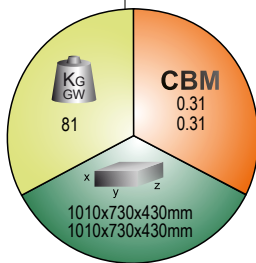

10.643



## Salerno

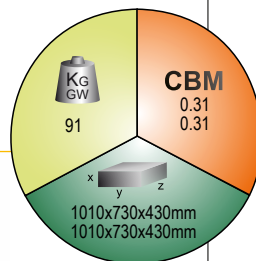

Flexible Pop Up wall system. The framework is made of aluminium. The construction makes it easy and fast to assemble. The system can be use in presentations, marketing events and shows. Printing and graphics it's not includes.

Includes:

- Pop Up Frame 3x3 straight x 1 / 3x2 straight x 2.
- Corner accessoires: 2 set.
- Spotlights: 4 units.
- Plastic Packing Case: 2 units.

**Material:** Aluminium, plastic parts.

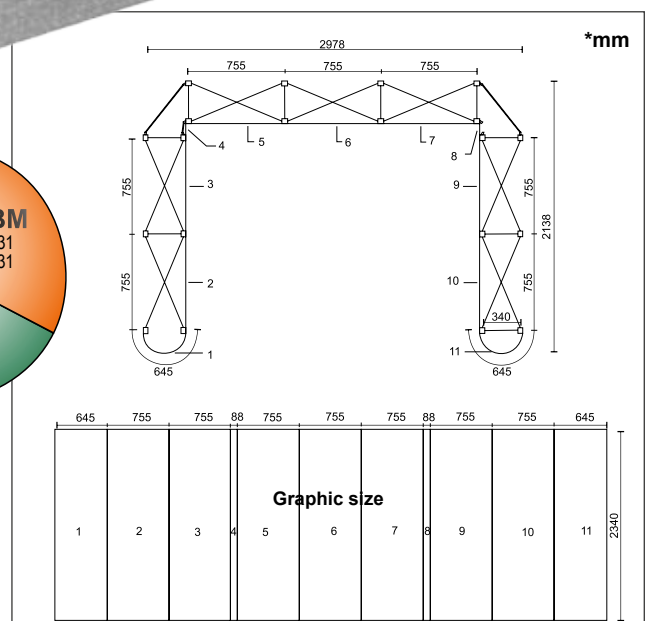

10.641



## Turin

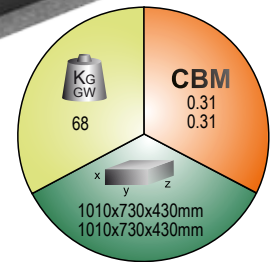

Flexible Pop Up wall system. The framework is made of aluminium. The construction makes it easy and fast to assemble. The system can be use in presentations, marketing events and shows. Printing and graphics it's not includes.

Includes:

- Pop Up Frame 3x1 straight x 4 sets.
- Corner accesiores: 6 sets.
- Spotlights: 2 units.
- Plastic Packing Case: 2 units.

**Material:** Aluminium, plastic parts.

10.645

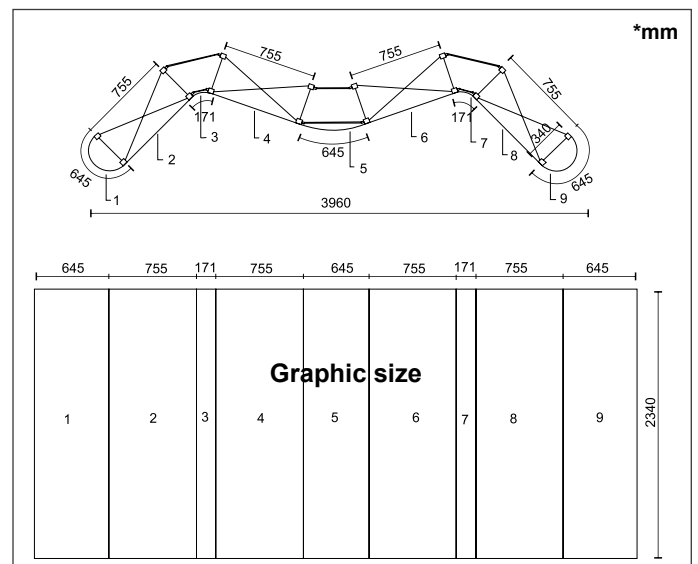



## Génova

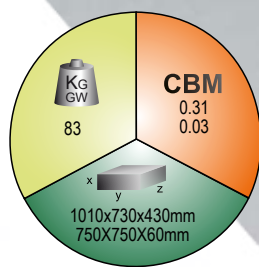

Flexible Pop Up wall system. The framework is made of aluminium. The construction makes it easy and fast to assemble. The system can be use in presentations, marketing events and shows. Printing and graphics it's not includes.

Includes:

- Pop Up Frame 3x3 straight x 1 / Pop Up 3x2 straight x 2.
- Corner accessoires: 3 set.
- Spotlights: 2 units.
- Plastic Packing Case: 2 units.

**Material:** Aluminium, plastic parts.

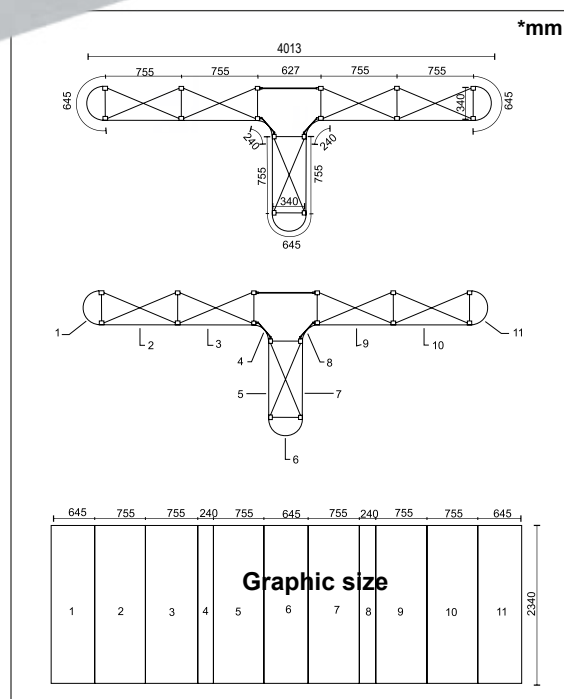

10.644



## Profile Stand

Aluminium profile for exhibitions stands.

**Material:** Aluminium.

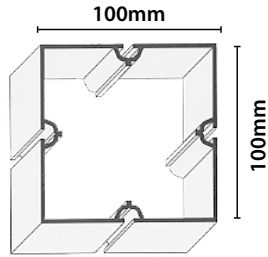
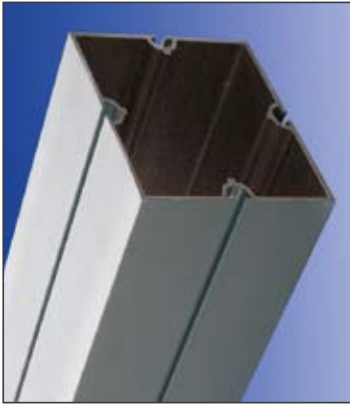

**15.116**      **100mm**

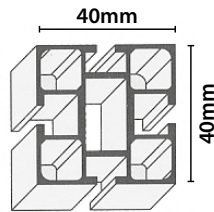

**15.118**      **40mm**



## Plastic Pieces for Tension Graphics



Plastic pieces for tension graphics in profile.

**Material:** Plastic, steel.



**15.723**      **Pack 10 Uni.**

## Aluminium Connector for Profile 100mm

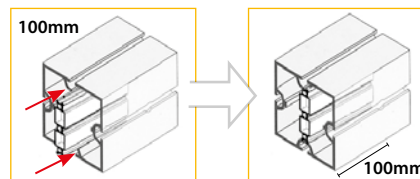

For 100mm profile you must use 2 locks and 1 for 40mm profile.

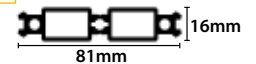

**Material:** Aluminium.



**15.117**      **Conector 100mm**

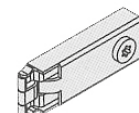
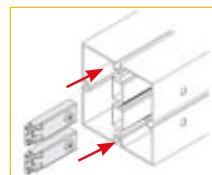

**15.119**      **Lock 100mm**

## Glass Wall

Glass wall systems are premium quality exhibit pieces that offer infinite versatility to help display your products or services. It's used with 100mm profile aluminium stand.

**Material:** Steel.

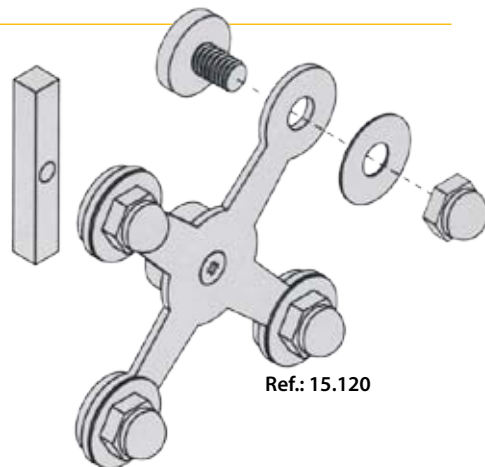

Ref.: 15.120

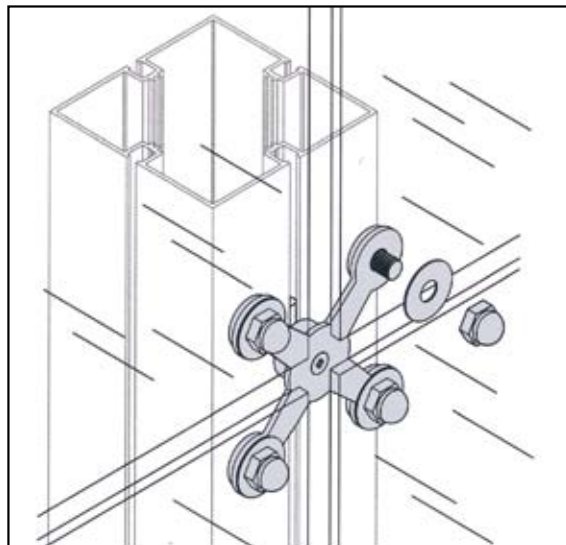

Front View

Top View

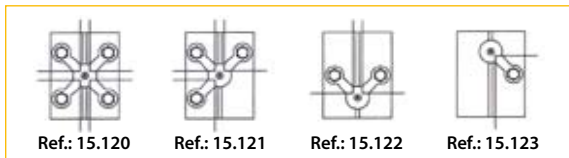
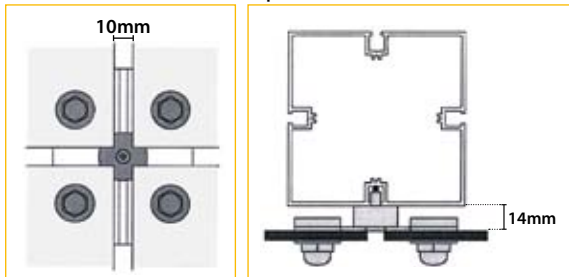

15.120	4 Parts	
15.121	3 Parts	
15.122	2 Parts	
15.123	1 Part	

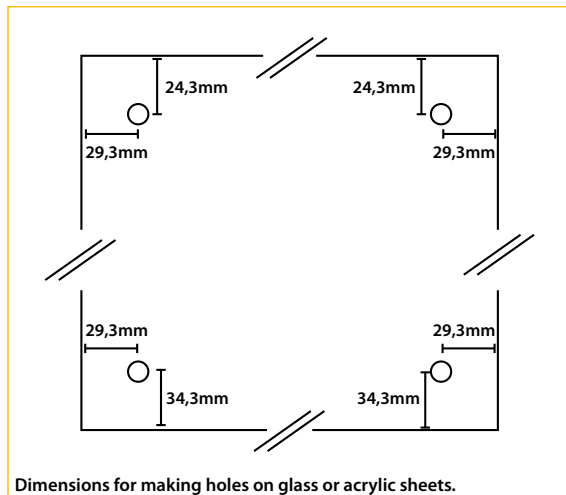

Dimensions for making holes on glass or acrylic sheets.

# ALUMINIUM TRUSS "EVENTS"

2

## Vertical Aluminium Truss

Lightweight. Easy and fast to assemble. Colour: natural silver.

**Material:** Aluminium.

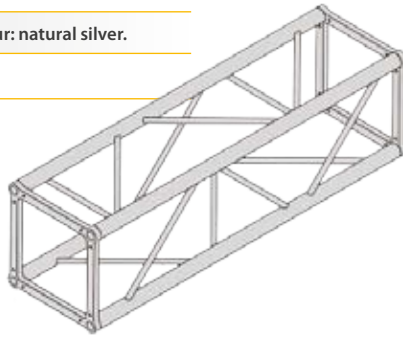

Code	Length	Width	Diagram	Diagram
15.000	1000mm	250mm		
15.001	1200mm	250mm		
15.002	1300mm	250mm		
15.003	1500mm	250mm		
15.004	1600mm	250mm		
15.005	1800mm	250mm		
15.006	2000mm	250mm		
15.007	2400mm	250mm		

## Curved Aluminium Truss

Easy and fast to assemble. Colour: natural silver.

**Material:** Aluminium.

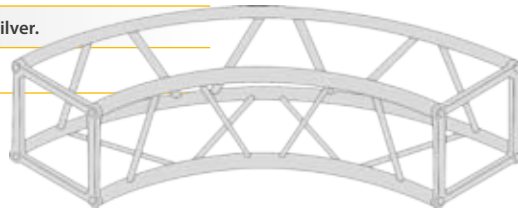

Code	Length	Width	Diagram	Diagram
15.015	2600mm - 45°	250mm		
15.016	1800mm - 60°	250mm		
15.017	1000mm - 90°	250mm		

## Aluminium Truss Connector

Aluminium truss connector square for vertical truss.

**Material:** Aluminium.

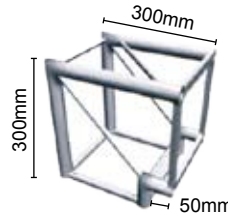

Ref.: 15.008



Ref.: 15.009

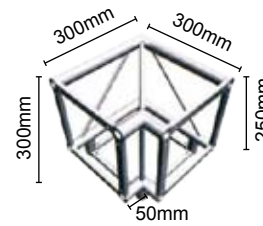

Ref.: 15.010

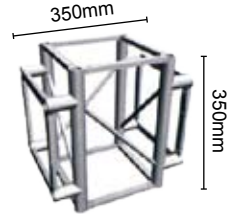

Ref.: 15.011



Ref.: 15.012

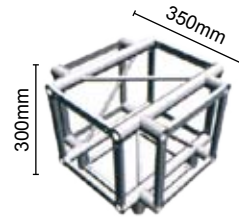

Ref.: 15.013

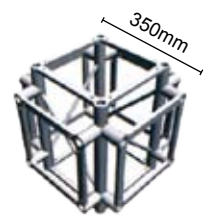

Ref.: 15.014

15.008	2 connection sides	<input type="checkbox"/>	
15.009	3 connection sides	<input type="checkbox"/>	
15.010	3 connection sides	<input type="checkbox"/>	
15.011	4 connection sides	<input type="checkbox"/>	
15.012	4 connection sides	<input type="checkbox"/>	
15.013	5 connection sides	<input type="checkbox"/>	
15.014	6 connection sides	<input type="checkbox"/>	

## Aluminium Connector Truss for Curves

Aluminium connector truss for curves.

**Material:** Aluminium.

15.018	45°	<input type="checkbox"/>
15.019	30°	<input type="checkbox"/>
15.020	60°	<input type="checkbox"/>

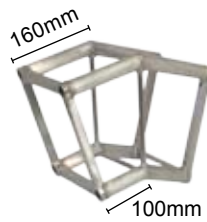

30°  
Ref.: 15.019

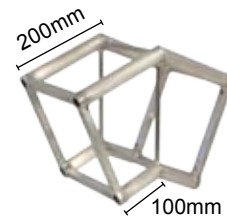

45°  
Ref.: 15.018

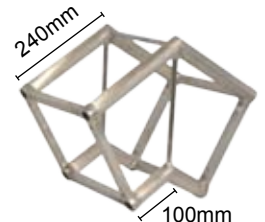

60°  
Ref.: 15.020



## Screws for Aluminium Truss

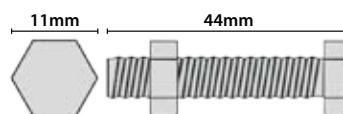

Steel screws for aluminium truss.

**Material:** Steel.

15.040	44x11mm	<input type="checkbox"/>
--------	---------	--------------------------



# ALUMINIUM TRUSS "SMALL SHOW"

2

## Vertical Aluminium Truss

Vertical aluminium truss, 32mm diameter. Ideal for producing and assembling a booth, venues, outdoor events, placing graphics, etc. It is characterized by its great resistance, lightweight and easy assembly. Colour: natural silver.

**Material:** Aluminium.



Code	Dimensions	Image	Length
15.170	500x150mm		5000mm
15.171	800x150mm		800mm
15.172	1000x150mm		1000mm
15.173	1200x150mm		1200mm
15.174	1500x150mm		1500mm

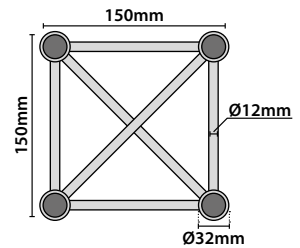

## Curved Aluminium Truss

Curved aluminium truss, 32mm diameter. Colour: natural silver.

**Material:** Aluminium.



15.175	1800mm - 45°	<input type="checkbox"/>
15.176	1200mm - 60°	<input type="checkbox"/>
15.177	1000mm - 90°	<input type="checkbox"/>
15.178	800mm - 90°	<input type="checkbox"/>

## Connector Truss

Connector aluminium truss 150x150x150mm. Colour: natural silver.

**Material:** Aluminium.



Ref.: 15.179

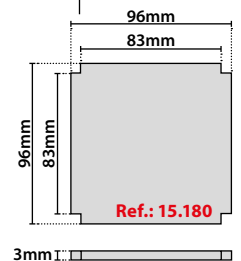
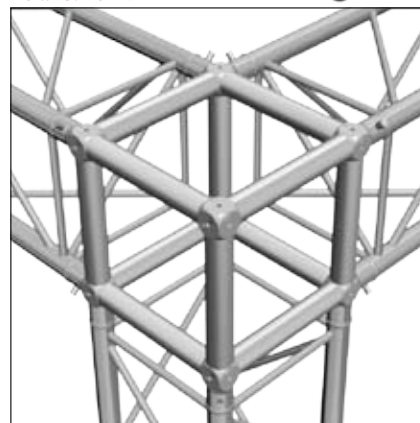

15.179	150x150x150mm	<input type="checkbox"/>
15.180	150x150x150mm	<input type="checkbox"/>

## ACCESORIES TO CONNECTING TRUSS "SMALL SHOW"

### Conical Connector

Conical connector.



**Material:** Aluminium.

15.148

### Half Conical Connector

Half conical connector



**Material:** Aluminium + bolt.

15.151

### Pin

Pin.



**Material:** Steel.

15.149

### Safety Clip

Safety clip.



**Material:** Steel.

15.150

### Base

Base.

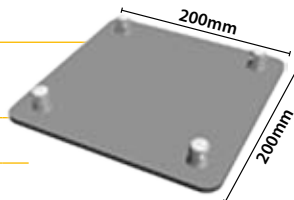

**Material:** Steel.

15.181

200x200mm

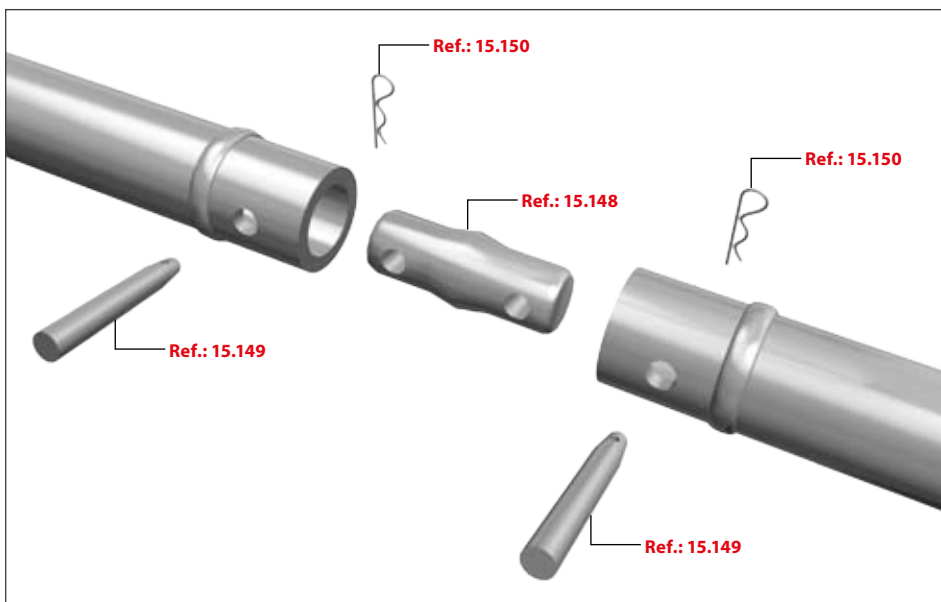

# ALUMINIUM TRUSS "SHOW"

2

## Vertical Aluminium Truss

Vertical aluminium truss, 32 mm diameter. Ideal for producing and assembling a booth, venues, outdoor events, placing graphics, etc. It is characterized by its great resistance, lightweight and easy assembly. Colour: natural silver.

**Material:** Aluminium.

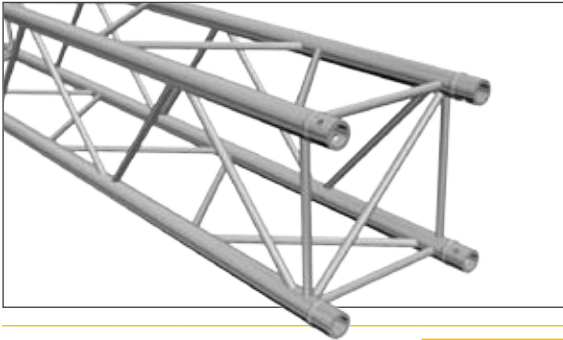

15.141	1000x250mm	<input type="checkbox"/>
15.142	1200x250mm	<input type="checkbox"/>
15.143	1500x250mm	<input type="checkbox"/>
15.144	1800x250mm	<input type="checkbox"/>
15.145	2000x250mm	<input type="checkbox"/>
15.146	2400x250mm	<input type="checkbox"/>

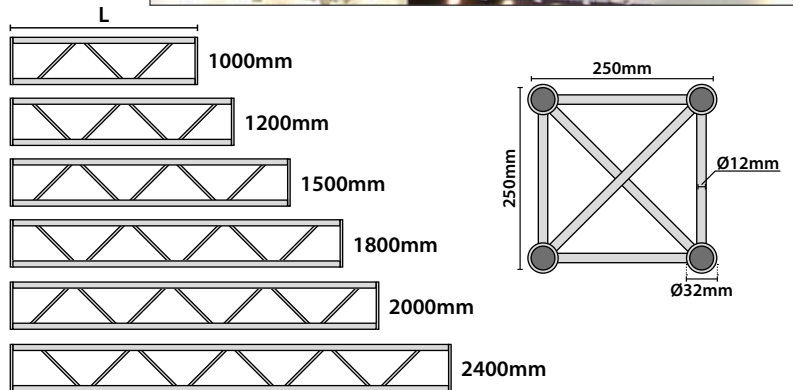

## Connector Truss

Connector aluminium truss. Colour: natural silver.

**Material:** Aluminium.

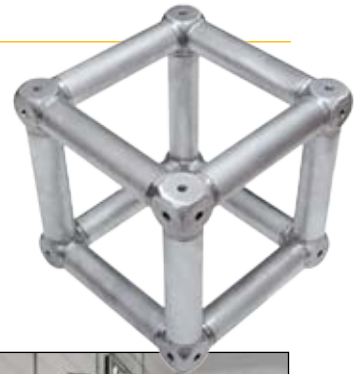
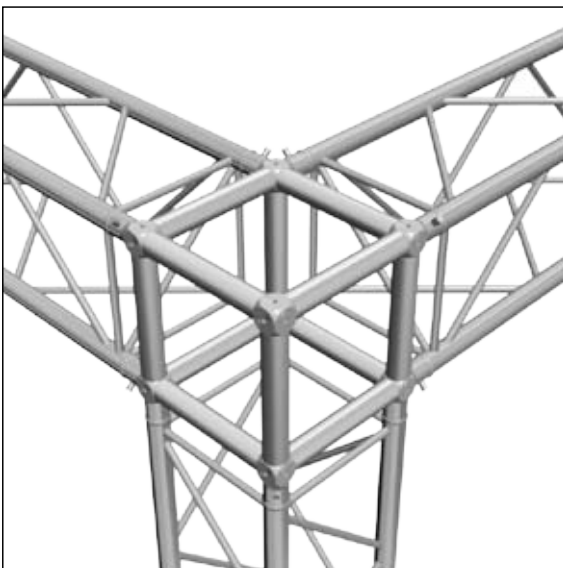

15.147	250x250x250mm	<input type="checkbox"/>
--------	---------------	--------------------------



## ACCESORIES TO CONNECTING TRUSS "SHOW"

### Conical Connector

Conical connector.

**Material:** Aluminium.



15.148

### Half Conical Connector

Half conical connector

**Material:** Aluminium + bolt.



15.151

### Pin

Pin.

**Material:** Steel.

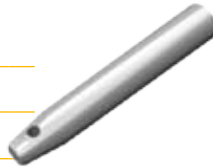

15.149

### Safety Clip

Safety clip.

**Material:** Steel.



15.150

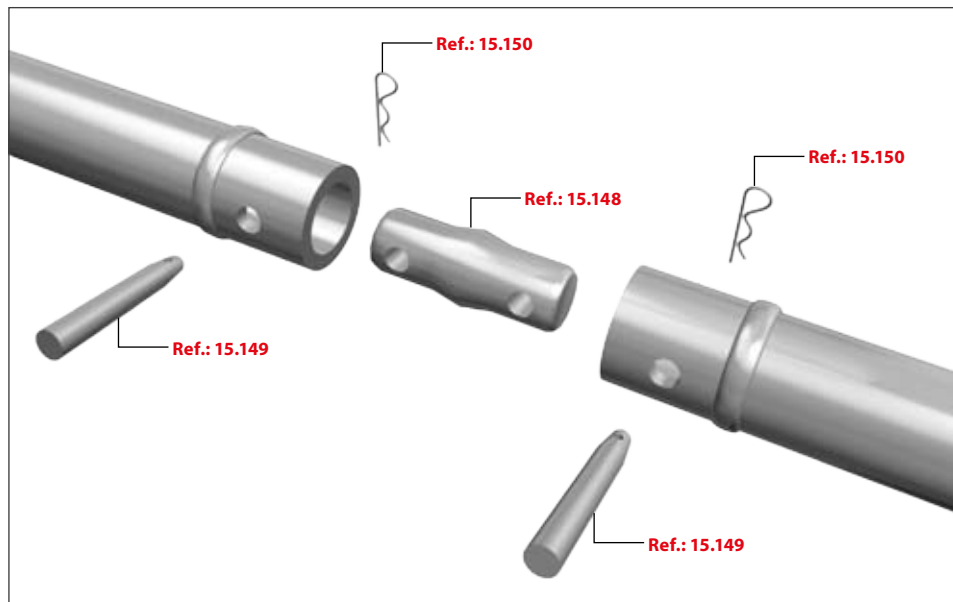
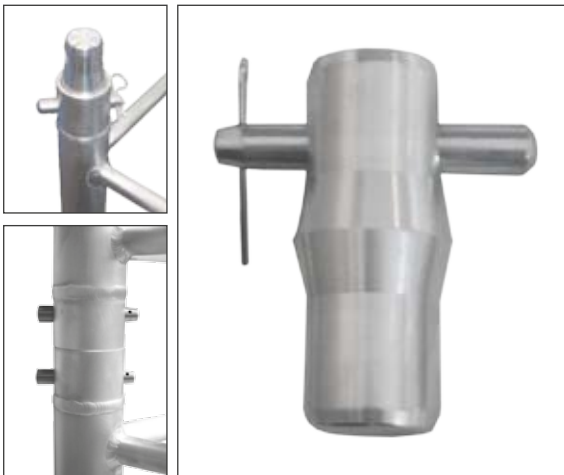

# ALUMINIUM TRUSS "BIG SHOW"

2

## Vertical Aluminium Truss

Vertical aluminium truss, 50 mm diameter. Ideal for producing and assembling a booth, venues, outdoor events, placing graphics, etc. It is characterized by its great resistance, lightweight and easy assembly. Colour: natural silver.

**Material:** Aluminium.

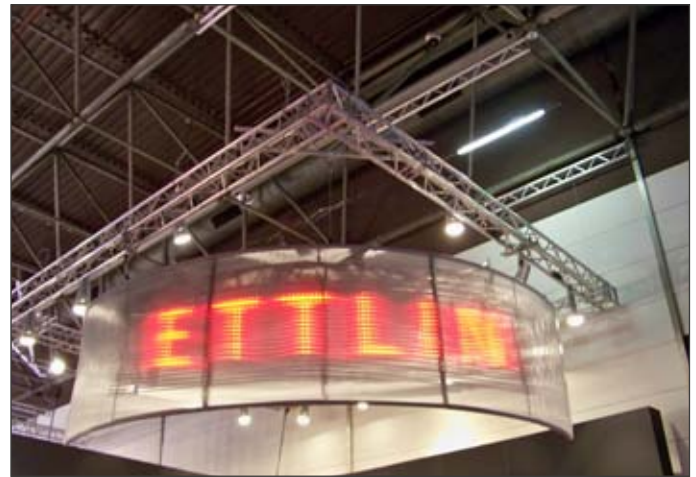
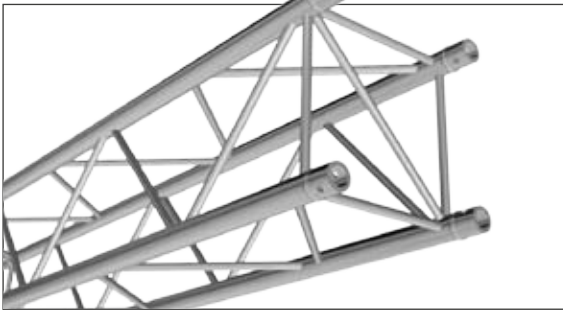

Code	Dimensions	Length (L)	Diagram
15.127	1000x300mm	1000mm	
15.128	1200x300mm	1200mm	
15.129	1500x300mm	1500mm	
15.130	1800x300mm	1800mm	
15.131	2000x300mm	2000mm	
15.132	2400x300mm	2400mm	

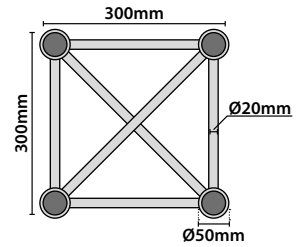

## Connector Truss

Connector aluminium truss. Colour: natural silver.

**Material:** Aluminium.

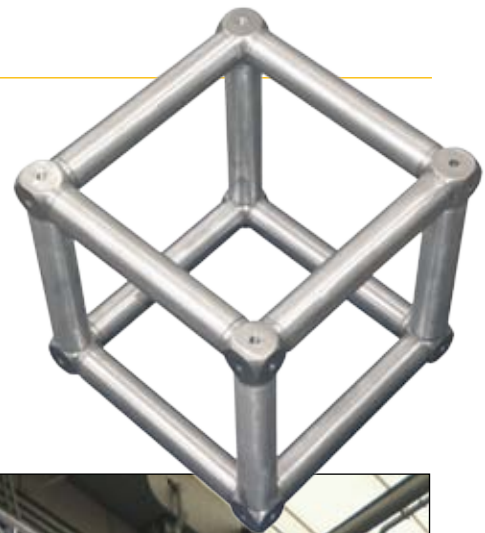
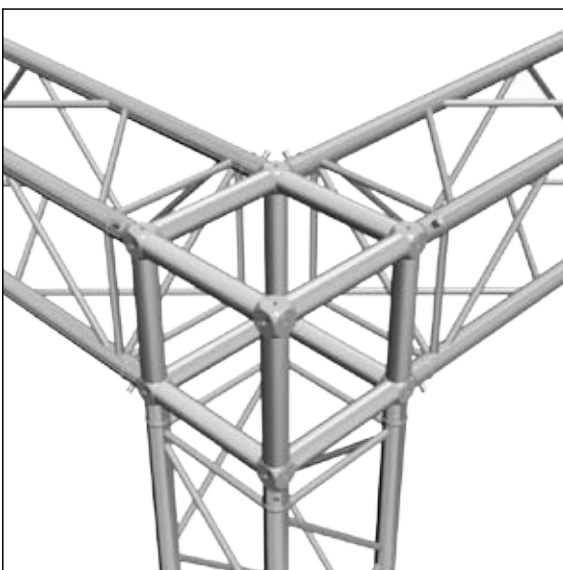

15.133	300x300x300mm	
--------	---------------	--

## ACCESORIES TO CONNECTING TRUSS "BIG SHOW"

### Conical Connector

Conical connector.



**Material:** Aluminium.

15.135

### Half Conical Connector

Half conical connector



**Material:** Aluminium + bolt.

15.138

### Pin

Pin.

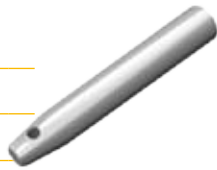

**Material:** Steel.

15.136

### Safety Clip

Safety clip.



**Material:** Steel.

15.137

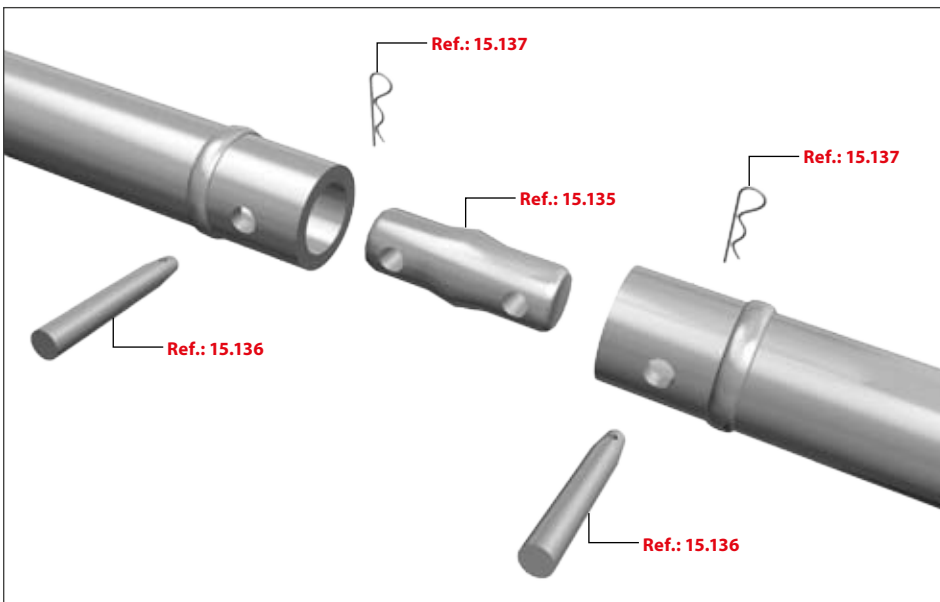
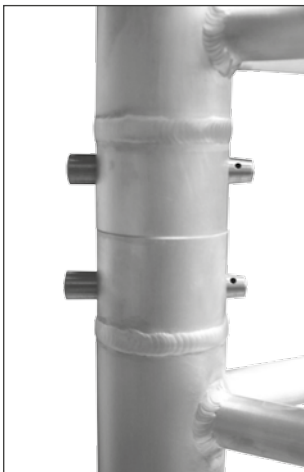

# ALUMINIUM TRUSS "TRIANGLE"

2

## Vertical "Triangle" Truss

Lightweight. Easy and fast to assemble. Colour: natural silver.

**Material:** Aluminium.

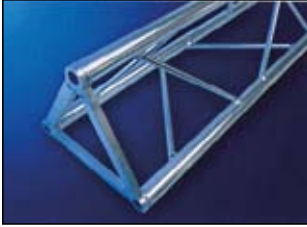

Code	Length (mm)	Width (mm)	Diagram
15.021	1000mm	250mm	
15.022	1200mm	250mm	
15.023	1300mm	250mm	
15.024	1500mm	250mm	
15.025	1600mm	250mm	
15.026	1800mm	250mm	
15.027	2000mm	250mm	
15.028	2400mm	250mm	

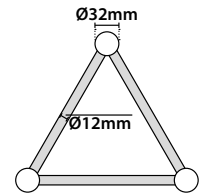
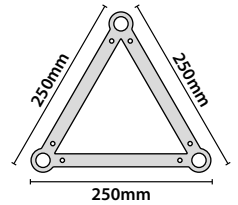

## Curved "Triangle" Truss

Easy and fast to assemble. Colour: natural silver.

**Material:** Aluminium.

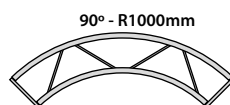
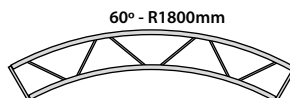
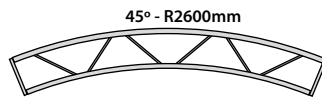
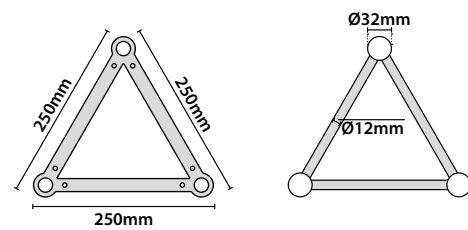
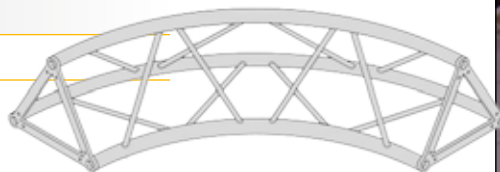









15.037	2600mm - 45°	
15.038	1800mm - 60°	
15.039	1000mm - 90°	



## Aluminium Triangle Truss Connector

Aluminium truss connector triangle for vertical truss.

**Material:** Aluminium.

15.029	2 connection sides	<input type="checkbox"/>	
15.140	2 connection sides	<input type="checkbox"/>	
15.030	3 connection sides	<input type="checkbox"/>	
15.031	3 connection sides	<input type="checkbox"/>	
15.032	4 connection sides	<input type="checkbox"/>	
15.033	4 connection sides	<input type="checkbox"/>	
15.034	4 connection sides	<input type="checkbox"/>	
15.035	5 connection sides	<input type="checkbox"/>	
15.036	6 connection sides	<input type="checkbox"/>	

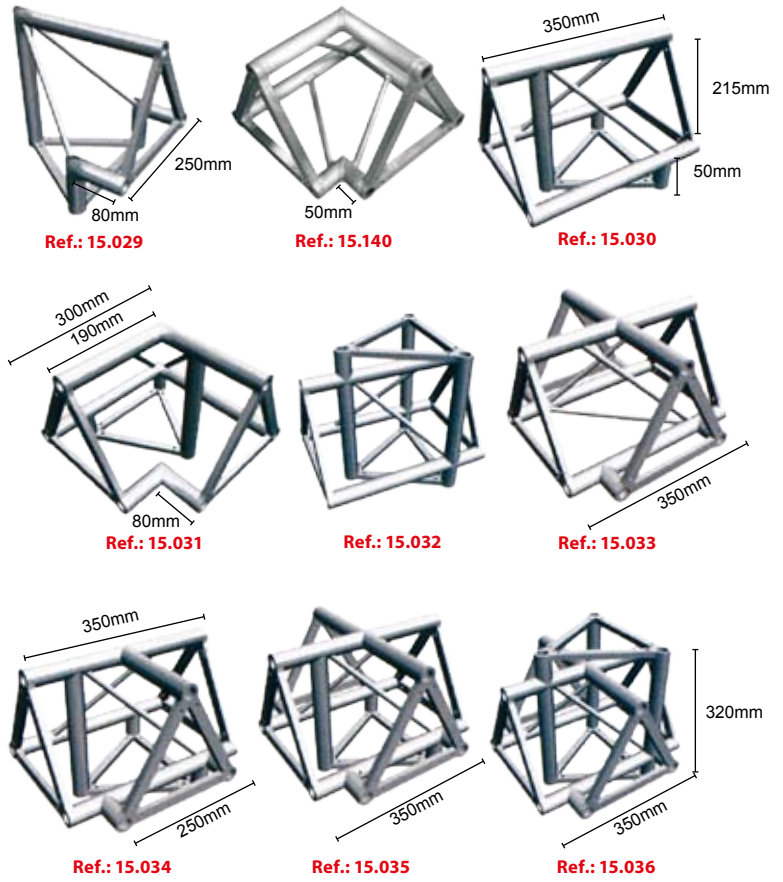

## Aluminium Connector Truss for Curves

Aluminium connector truss for curves.

**Material:** Aluminium.

15.124	30°	<input type="checkbox"/>
15.125	45°	<input type="checkbox"/>
15.126	60°	<input type="checkbox"/>



## Screws for Aluminium Truss

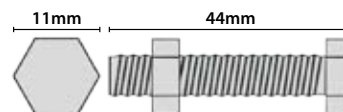

Steel screws for aluminium truss.

**Material:** Steel.

15.040 44x11mm

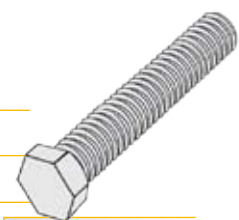

# ALUMINIUM TRUSS "DUO"

2

## Aluminium Truss "Duo"

Lightweight. Easy and fast to assemble. Colour: natural silver.

**Material:** Aluminium.

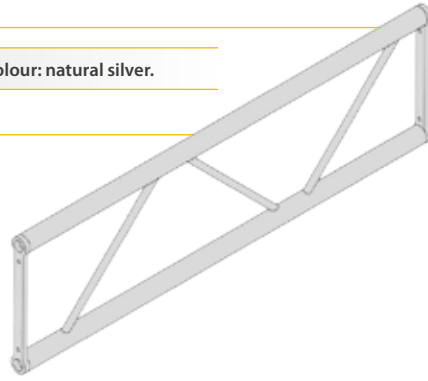
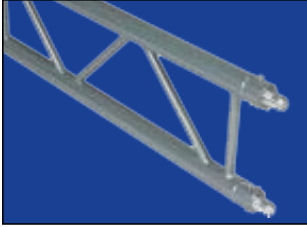

Code	Length	Diagram	Length
15.060	1000mm		1000mm
15.061	1200mm		1200mm
15.062	1300mm		1300mm
15.063	1500mm		1500mm
15.064	1600mm		1600mm
15.065	1800mm		1800mm
15.066	2000mm		2000mm
15.067	2400mm		2400mm

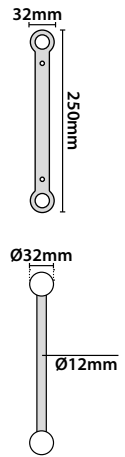

## Curved "Duo" Truss

Easy and fast to assemble. Colour: natural silver.

**Material:** Aluminium.

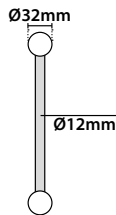
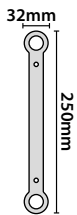
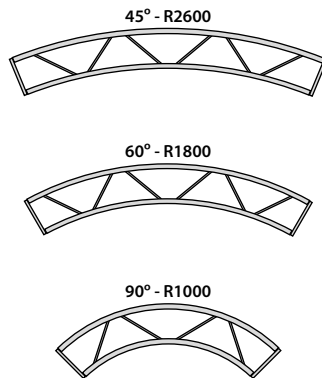
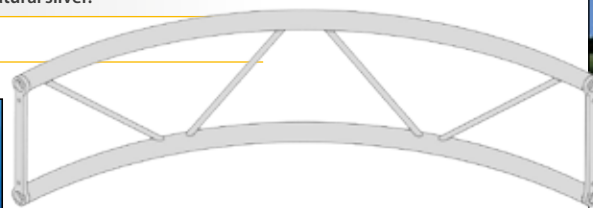
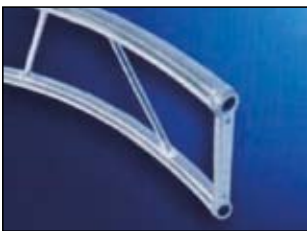

15.077	2600mm - 45°	<input type="checkbox"/>
15.078	1800mm - 60°	<input type="checkbox"/>
15.079	1000mm - 90°	<input type="checkbox"/>

## Aluminium "Duo" Truss Connector

Aluminium truss connector for vertical and horizontal "duo" truss.

**Material:** Aluminium.

15.068	2 connection sides	<input type="checkbox"/>	
15.069	3 connection sides	<input type="checkbox"/>	
15.070	3 connection sides	<input type="checkbox"/>	
15.071	3 connection sides	<input type="checkbox"/>	
15.072	3 connection sides	<input type="checkbox"/>	
15.073	4 connection sides	<input type="checkbox"/>	
15.074	4 connection sides	<input type="checkbox"/>	
15.075	5 connection sides	<input type="checkbox"/>	
15.076	6 connection sides	<input type="checkbox"/>	



Ref.: 15.068



Ref.: 15.069



Ref.: 15.070



Ref.: 15.071



Ref.: 15.072



Ref.: 15.073



Ref.: 15.074



Ref.: 15.075



Ref.: 15.076

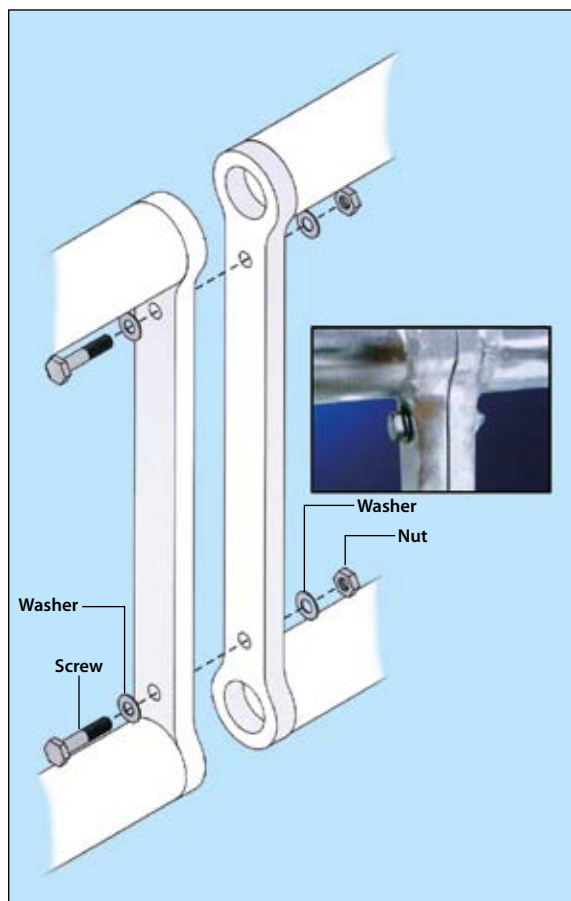

## Screws for Aluminium Truss

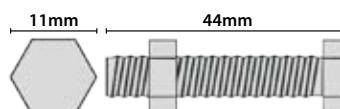

Steel screws for aluminium truss.

**Material:** Steel.

15.040 44x11mm

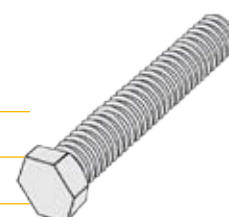

## Floor System

System platform using tongue and groove panels with graphic carrier. Made of different colors.

**Material:** Plastic.

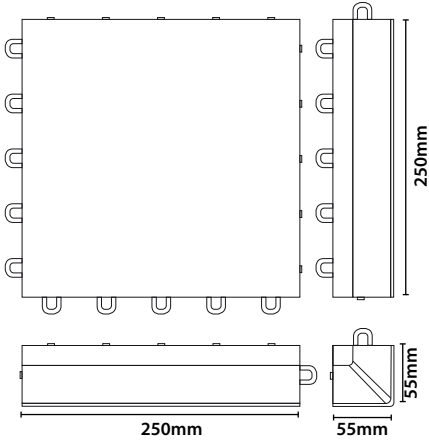

### Colour Floor System

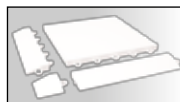
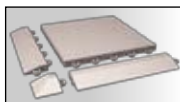
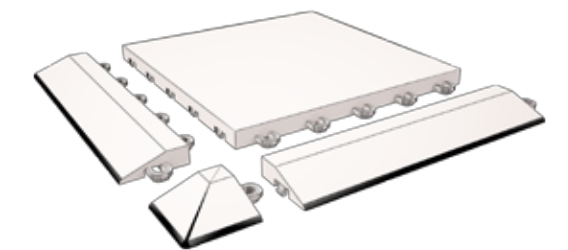
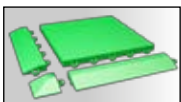
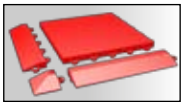
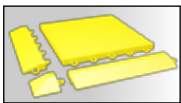
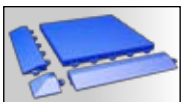

### Floor System Graphic Insert

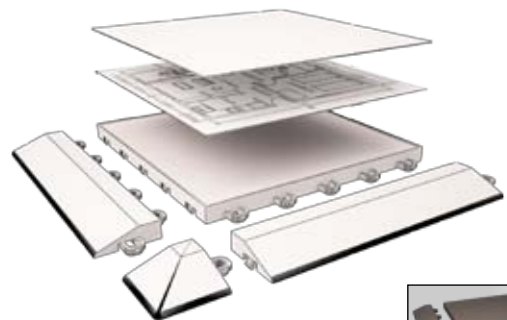



## Colour Floor System



Platform system using tongue and groove panels. Made of diferent colors.

**Material:** Plastic.

15.209 Packing 16 Uni. (1 mt<sup>2</sup>).

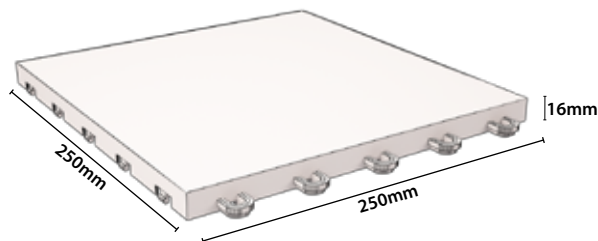

## Floor System Frame and Corner

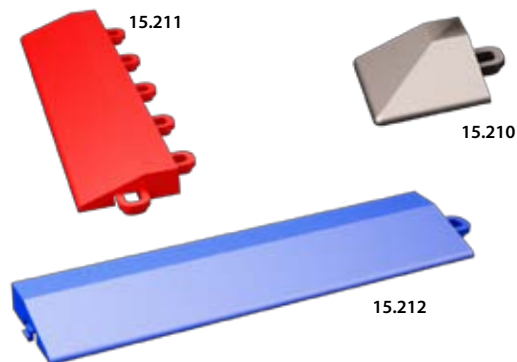

## Floor System Graphic Insert

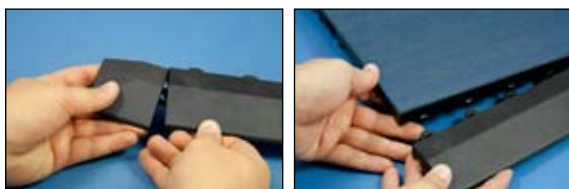

Platform system using tongue and groove panels. Made of diferent colors.

**Material:** Plastic.



15.210 Corner Packig 4 Uni.

15.211 Frame Male Packig 8 Uni.

15.212 Frame Female Packig 8 Uni.

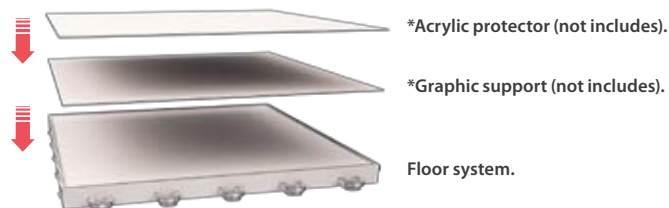
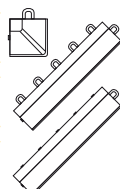

System platform using tongue and groove panels with graphic carrier. Made of diferent colors.

**Material:** Plastic.

15.199 Packing 16 Uni. (1 mt<sup>2</sup>). 248x248mm

\*Printing



2

## Flat Non Skid Profile

Flat aluminium profile for stands, floors, etc.

**Material:** Aluminium.

**15.197** Packing 5 Uni. x3m.

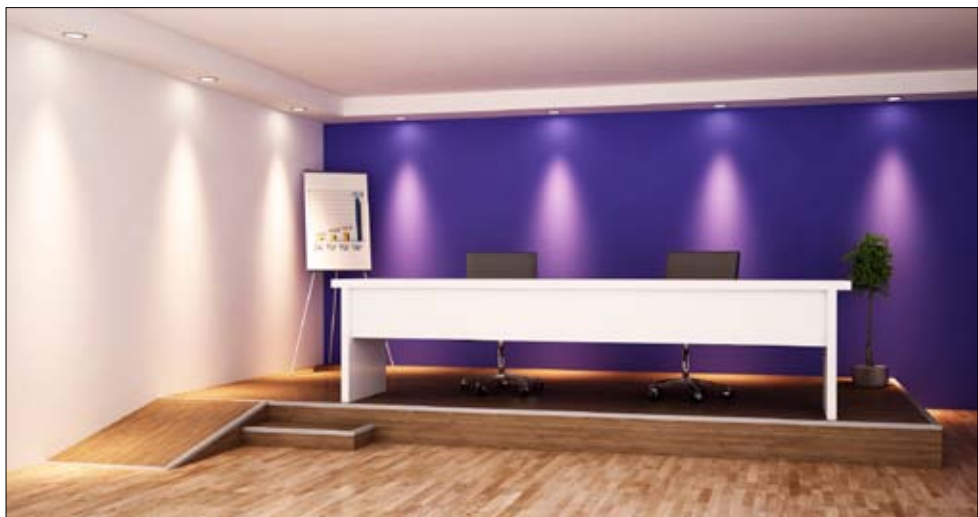
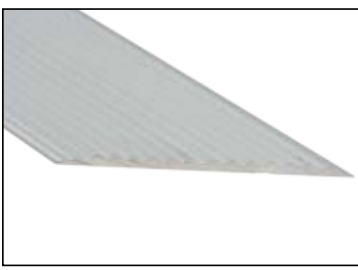
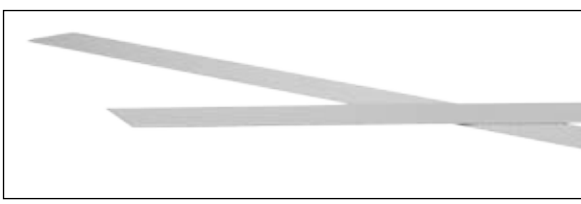
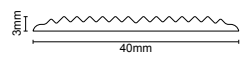

## Angle Non Skid Profile

Angle aluminium profile for stands, floors, etc.

**Material:** Aluminium.

**15.198** Packing 5 Uni. x3m.

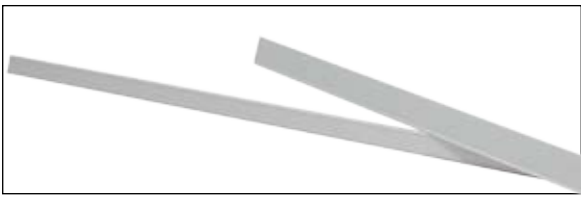
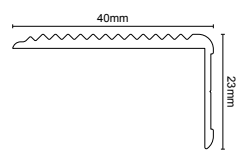

## Duccio



Plastic chair made of ABS and chromed steel frame.

	QTY	N.W	C.B.M.	Size(mm)
Packing	4	5.5	0.26	760x630x550

- 31.152 ■
- 31.153 ■

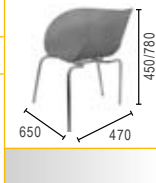

## Naldini



Plastic chair made of ABS and chromed steel frame.

	QTY	N.W	C.B.M.	Size(mm)
Packing	4	7	0.14 0.15	455x590x520 600x530x480

- 31.132 ■
- 31.133 ■
- 31.134 □

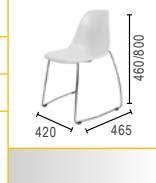

## Cézanne



Resistant high chair made of plastic.

	QTY	N.W	C.B.M.	Size(mm)
Packing	4	16.8	0.27	840x665x490

- 31.238 ■
- 31.237 □

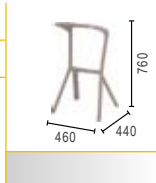

## Pels



High Bar stool of chromed structure and ABS plastic seat.

	QTY	N.W	C.B.M.	Size(mm)
Packing	1	11.4	0.1	570x400x400

- 31.086 ■
- 31.087 ■
- 31.115 □

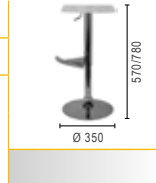

## Fouquet



Chair made of ABS plastic and chromed structure.

	QTY	N.W	C.B.M.	Size(mm)
Packing	2	17.2	0.27	580x780x580

- 31.070
- 31.072
- 31.071



## Stylus



Chair made of ABS plastic and chromed structure.

	QTY	N.W	C.B.M.	Size(mm)
Packing	2	13.6	0.11	590x415x460

- 36.028
- 36.029



## VanDick



High Bar stool of chromed structure and ABS plastic seat.

	QTY	N.W	C.B.M.	Size(mm)
Packing	2	14.8	0.08	420x520x350

- 31.047
- 31.063



## Chagall



High Bar stool of chromed structure and seat with rubber coating.

	QTY	N.W	C.B.M.	Size(mm)
Packing	2	14	0.13	420x640x480

- 31.196
- 31.198
- 31.197



## Sisley



High Bar stool with chromed structure and seating upholstered of PVC.

	QTY	N.W	C.B.M.	Size(mm)
Packing	2	13.7	0.08	420x520x370

**31.080**

**31.113**

## Calviño



High Bar stool with seating upholstered of artificial leather and chromed structure.

	QTY	N.W	C.B.M.	Size(mm)
Packing	1	9.5	0.08	430x500x370

**31.094**

**31.096**

## Swan



Chair made of ABS plastic and chromed structure.

	QTY	N.W	C.B.M.	Size(mm)
Packing	2	13.5	0.10	590x415x410

**36.030**

**36.031**

## Caron



Adjustable chair in height, made of artificial leather and chromed structure.

	QTY	N.W	C.B.M.	Size(mm)
Packing	1	14.8	0.24	410x760x760

**31.227**

**31.226**

**31.229**

**31.228**

**31.230**

## Prostool



36.027

High Bar stool with seating manufacturing in PVC and chromed structure.

	QTY	N.W	C.B.M.	Size(mm)
Packing	2	15	0.207	535x475x815

36.027 ■

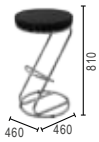

## Borneo



36.018

Chair gray structure folding and wooden seat.

	QTY	N.W	C.B.M.	Size(mm)
Packing	4	13	0.104	900x505x230

36.018 ■



## Director



36.026

Chair gray structure folding and Nylon seat.

	QTY	N.W	C.B.M.	Size(mm)
Packing	4	17.5	0.144	810x380x470

36.025 ■

36.026 ■

36.044 ■

36.045 ■



## Mavick



36.020

Chair gray structure folding and PVC seat.

	QTY	N.W	C.B.M.	Size(mm)
Packing	6	22	0.113	900x280x450

36.019 ■

36.020 ■

36.022 ■

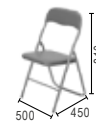

## Swanp



36.033

High Bar stool with chromed structure and seating upholstered of PVC.

	QTY	N.W	C.B.M.	Size(mm)
Packing	2	13.5	0.10	590x415x410

- 36.032
- 36.033

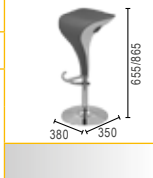

## Lotto



31.041

31.040



31.042

High Bar Table of chromed structure, ABS plastic and come with footrest.

	QTY	N.W	C.B.M.	Size(mm)
Packing	2	23.4	0.37	650x770x735

- 31.041
- 31.042
- 31.040



## Bertram



31.186



31.188



31.187

Low table made of ABS plastic and tempered glass.

	QTY	N.W	C.B.M.	Size(mm)
Packing	1	9.8	0.13	530x530x450

- 31.186
- 31.187
- 31.188

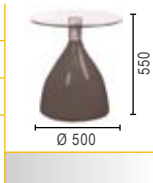

## Sanzio



31.191

31.190

High folding Table made of ABS plastic with metallic structure.

	QTY	N.W	C.B.M.	Size(mm)
Packing	1	9	0.058 0.006	620x620x150 920x80x80

- 31.190
- 31.191
- 31.189

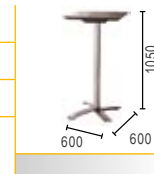

## Baldung



Adjustable height coffee table. Structure chrome and tempered glass.

	QTY	N.W	C.B.M.	Size(mm)
Packing	1	8.5	0.2	535x535x700

31.255

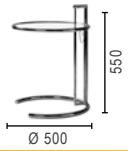

## Nisart



Low table made of ABS plastic.

	QTY	N.W	C.B.M.	Size(mm)
Packing	1	15.5	0.06 0.17	930x930x600 470x470x740

31.185

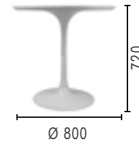

## Ottino



31.083

31.082

Bar table. Ideal for shows and exhibitions. PVC and steel chrome.

	QTY	N.W	C.B.M.	Size(mm)
Packing	1	9.5	0.076 0.321	620x620x200 180x180x990

31.182



31.083



## Gauguin



31.027

Folding round table. Material: Aluminium frame and plastic table. Diferents colours.

	QTY	N.W	C.B.M.	Size(mm)
Packing	1	9.5	0.1	150x820x820

31.025



31.026



31.027





## Poussin



31.030

Folding square table. Material: Aluminium frame and plastic table.

	QTY	N.W	C.B.M.	Size(mm)
Packing	1	8.5	0.06	160x620x620

- 31.028
- 31.029
- 31.030



## Rubens



31.037

31.039

Bar table. Ideal for shows and exhibitions. PVC and steel chrome.

	QTY	N.W	C.B.M.	Size(mm)
Packing	1	8.1	0.48	680x700x1000 990x180x180

- 31.038
- 31.039
- 31.037

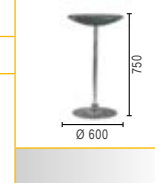

## Vives



31.046

31.062

High table with chrome frame and wooden board.

	QTY	N.W	C.B.M.	Size(mm)
Packing	1	10.57	0.06	620x620x170 965x180x180

- 31.046
- 31.062



## Tito



Computer desk metal frame and removable shelf.

	QTY	N.W	C.B.M.	Size(mm)
Packing	1	11	0.41	840x515x950

- 36.034
- 36.035

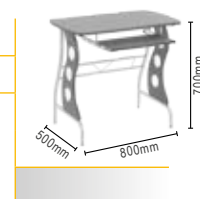



3



click frame stands  
and brochure stands

# ALUMINIUM FRAMES





3

## Lima

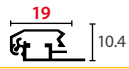

Frames for wall mount or hang from ceiling. Easy exchange of graphic thanks to its snap-clips on all four sides. Antireflection film. Strong and durable. Includes hanging accessories. Interior or exterior use.

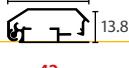
**Material:** Anodised aluminium.

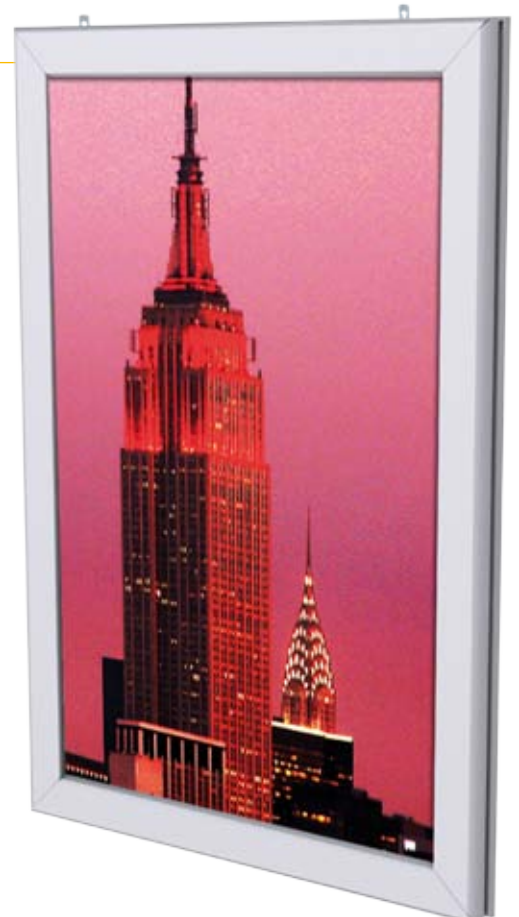

A4	A3	A2	A1	A0	500x700	700x1000	1000x1400	Size(mm)
10.210	10.209	10.208			10.211			 19 10.4
10.260	10.259	10.258			10.261			 25 11.5
	10.262	10.263	10.264		10.266	10.267		 32 13.8
				10.270		10.272	10.268	 42 13.8

## Lima Double Sided

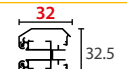

Frames made to be hang from the ceiling, double sided, easy exchange of graphic thanks to its snap-clips on all four sides. Antireflection film. Strong and durable. Interior or exterior use.

**Material:** Anodised aluminium.

A3	A2	A1	A0	500x700	700x1000	Size(mm)
10.563	10.564	10.565		10.289		 32 32.5
			10.257		10.560	 42 32.5

## Lima Lockable



42mm

Frames for wall mount or hang from ceiling. Easy exchange of graphic thanks to its snap-clips on all four sides. Antireflection film. Strong and durable. Interior or exterior use. One of the frames is close tight with a special screw.

**Material:** Anodised aluminium.

A1	A0	500x700	700x1000	1000x1400	Size(mm)
10.280	10.281	10.282	10.283	10.278	



## Lima Waterproof



42mm

Frames for wall mount or hang from ceiling. Easy exchange of graphic thanks to its snap-clips on all four sides. Antireflection film. Strong and durable. Interior or exterior use. Design to prevent water from going inside the frame.

**Material:** Anodised aluminium.

A1	A0	500x700	700x1000	1000x1400	Size(mm)
10.285	10.286	10.287	10.288	10.561	



# ALUMINIUM FRAMES

3

## Anadia



Frames for wall mount or hang from ceiling. Easy exchange of graphic thanks to its snap-clips on all four sides. Antireflection film. Strong and durable. Includes hanging accessories. Interior or exterior use.

**Material:** Anodised aluminium.

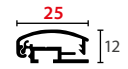
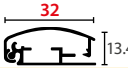
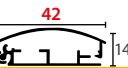
A4	A3	A2	A1	A0	500x700	700x1000	1000x1400	Size(mm)
10.214	10.213	10.212			10.215			 25 12
	10.290	10.291	10.292		10.293	10.294		 32 13.4
				10.296		10.295	10.297	 42 14.5

## Anadia Double Sided

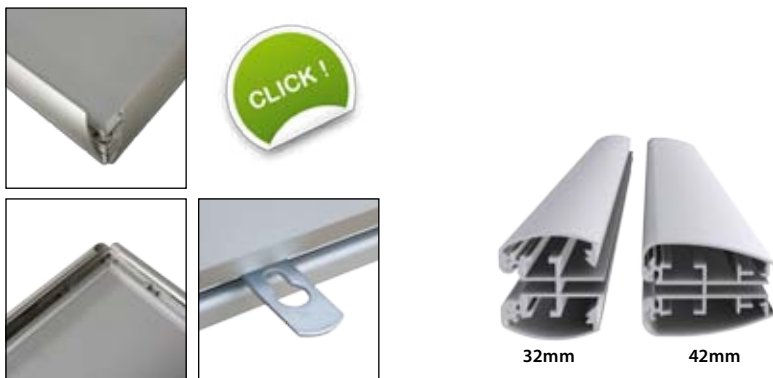

Frames made to be hang from the ceiling, double sided, easy exchange of graphic thanks to its snap-clips on all four sides. Antireflection film. Strong and durable. Interior or exterior use.

**Material:** Anodised aluminium.

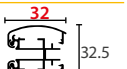
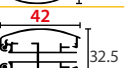
A3	A2	A1	A0	500x700	700x1000	Size(mm)
10.299	10.300	10.302		10.303		 32 32.5
			10.562		10.566	 42 32.5

## Serena



32mm



Frames for wall mount or hang from ceiling. Easy exchange of graphic thanks to its snap-clips on all four sides. Antireflection film. Strong and durable. Includes hanging accessories. Interior or exterior use.

**Material:** Anodised aluminium, plastic parts.

A4	A3	A2	500x700	700x1000	Size(mm)
10.405	10.404	10.403	10.408	10.163	



## Trujillo



32mm



Frames for wall mount or hang from ceiling. Easy exchange of graphic thanks to its snap-clips on all four sides. Antireflection film. Strong and durable. Interior or exterior use.

**Material:** Anodised aluminium, plastic parts.

A3	A2	A1	A0	500x700	700x1000	Size(mm)
10.131	10.132	10.133	10.134	10.135	10.136	
10.139	10.140	10.141	10.142	10.143	10.144	



# ALUMINIUM FRAMES

3

## Lublin



Anodised aluminium frame for wall mount. Easy exchange of graphic thanks to open by short side. Antireflection film. Strong and durable.

**Material:** Anodised aluminium.

A4	A3	A2	A1	Size(mm)
10.594	10.593	10.592	10.591	
10.590	10.589	10.588	10.587	



## Gavarnie



Exhibition frame for graphics. Frame made of aluminium and plastic clips to hold the graphic in place. Includes two hanging pieces.

**Material:** Aluminium, plastic parts.

A4	A3	A2	A1	A0
10.508	10.507	10.506	10.505	10.509



## Bayonne

"A" snapframe. Double sided, frame announcement board with durable aluminium clip frame. Folding for posters presentation. Poster or sheets are protected by a thin laminated plastic for a quality look.

**Material:** Aluminium, plastic parts.

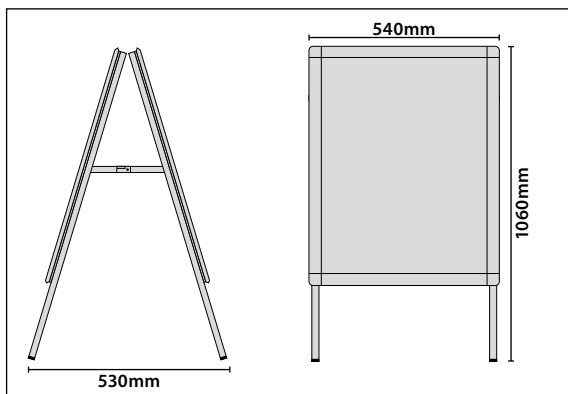

**10.804**    **500x700mm**

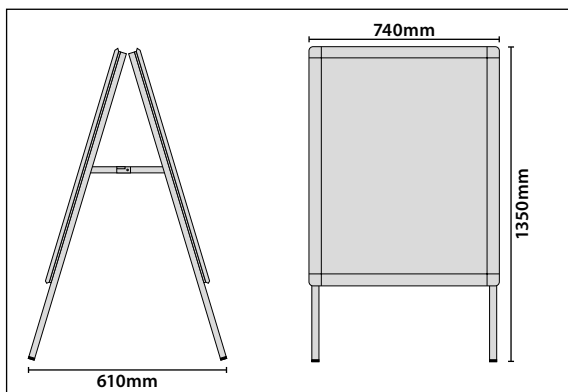
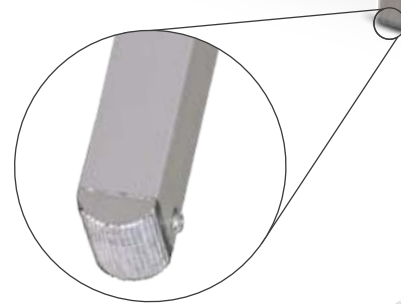

**10.805**    **700x1000mm**



## Antireflection Sheet

Antireflection sheet for snapframe.

**10.952**    **500x700mm**

**10.953**    **700x1000mm**



# ALUMINIUM FRAMES

3

## Niza



**ECONOMIC!**



One sided poster frame aluminium stand. Poster or sheets are protected by a thin anti-reflex cover. Indoor / Outdoor use.

**Material:** Aluminium, plastic parts.

10.808

500x700mm



## Merida



Double sided, frame announcement board with durable aluminium clip frames and plastic rounded on corners. Folding for posters presentation. Poster or sheets are protected by a thin laminated plastic for a quality look. Different colours are available.

**Material:** Aluminium, plastic parts.



A1	500x700	700x1000
10.337	10.338	10.339
10.119	10.122	10.124
10.120	10.123	10.125



## Grenoble

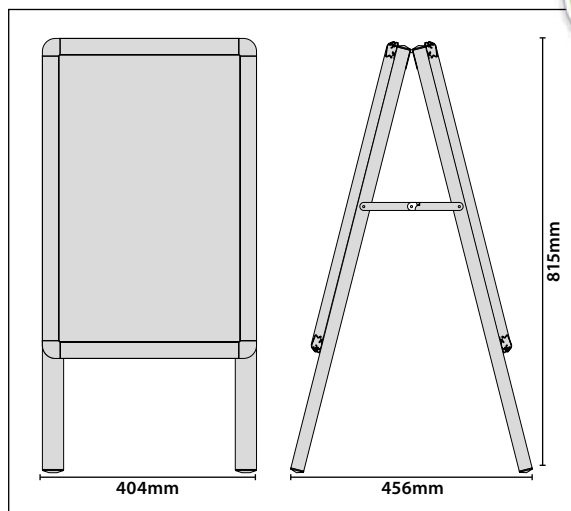

Double sided, frame announcement board with durable aluminium clip frames and plastic rounded on corners. Folding for posters presentation. Poster or sheets are protected by a thin laminated plastic for a quality look.

**Material:** Aluminium, plastic parts.



32mm

	QTY	N.W(kg)	G.W(kg)	C.B.M.	Size(mm)
Packing	1	4.3	5	0.0374	880x425x100
<b>10.942</b>		<b>360x560mm</b>			



## Poznan

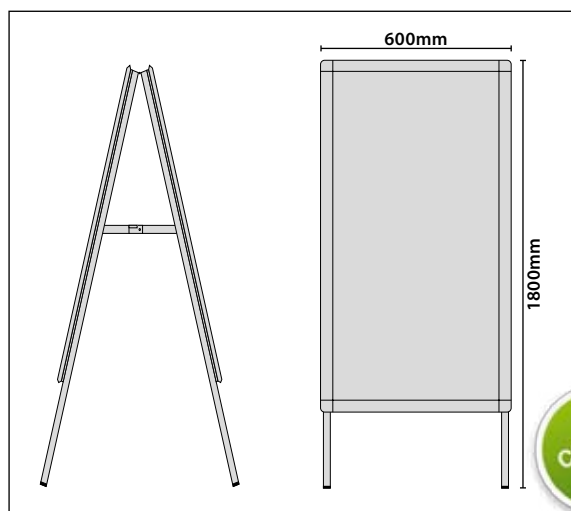

32mm



Double sided, frame announcement board with durable aluminium clip frames and plastic rounded on corners. Folding for posters presentation. Poster or sheets are protected by a thin laminated plastic for a quality look.

**Material:** Aluminium, plastic parts.

	QTY	N.W(kg)	G.W(kg)	C.B.M.	Size(mm)
Packing	1	12.6	15	0.177	705x135x1860
<b>10.343</b>		<b>600x1500mm</b>			



# ALUMINIUM FRAMES

3

## Dijon

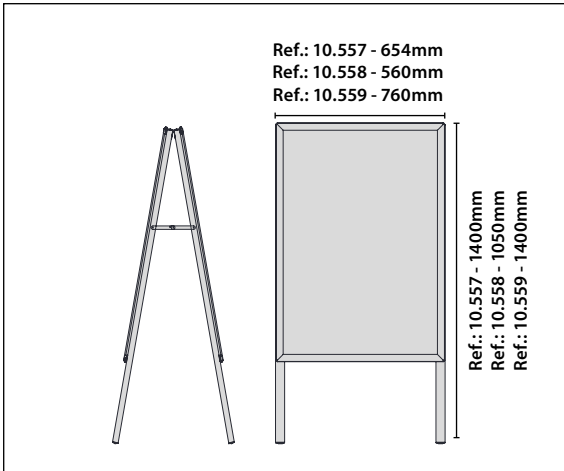

Double sided, frame announcement board with durable aluminium clip frames. Folding for posters presentation. Poster or sheets are protected by a thin laminated plastic for a quality look.

**Material:** Aluminium, plastic parts.

10.557	A1		
10.558	500x700mm		
10.559	700x1000mm		



## Toulouse

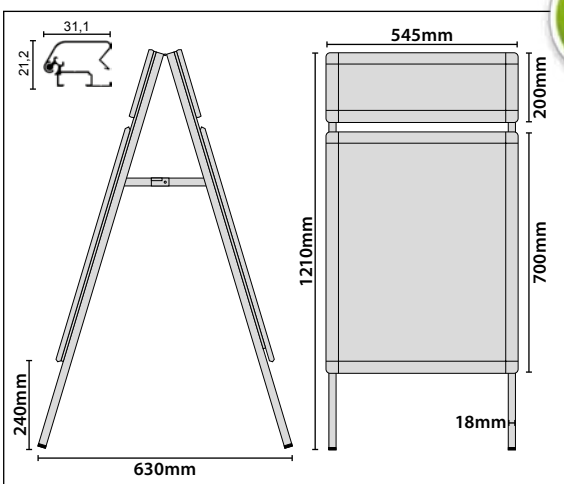

Double sided, frame announcement board with durable aluminium clip frame. Includes two frames of 500x700mm and two headframes of 500x200mm. Poster or sheets are protected by a thin anti-reflex cover.

**Material:** Aluminium, plastic parts.

10.806	500x700mm 500x200mm		
--------	------------------------	--	--



## Belmez

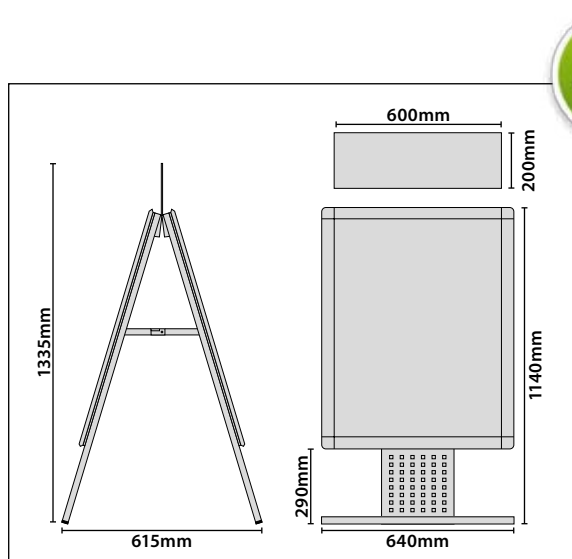

Double sided, frame announcement board with durable aluminium clip frame steel feet. Poster or sheets are protected by a thin anti-reflex cover for a quality look. Headboard included. Headboard size: 600x200mm.

**Material:** Aluminium, steel, plastic parts.

10.235

A1



## Montánchez

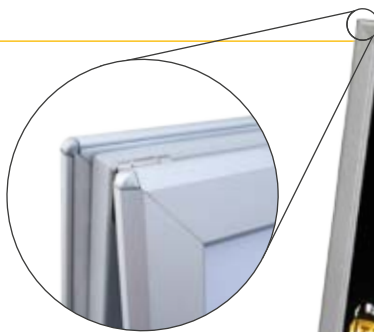
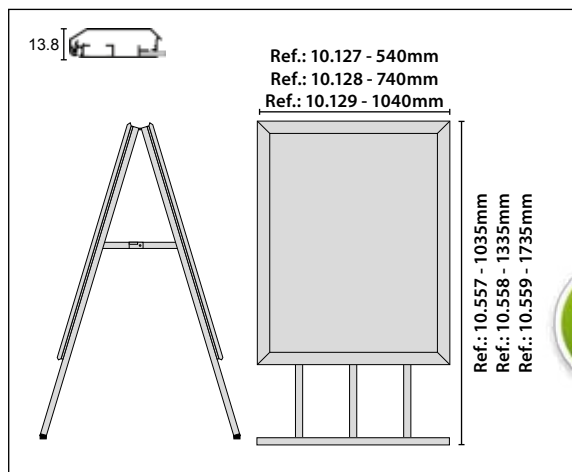

"A" Snapframe stand. Double sided poster stand for indoor or outdoor use. Aluminium click frame.

**Material:** Aluminium, steel, plastic parts.

10.127

500x700mm



10.128

700x1000mm



10.129

1000x1400mm



42mm

## Ibahernando

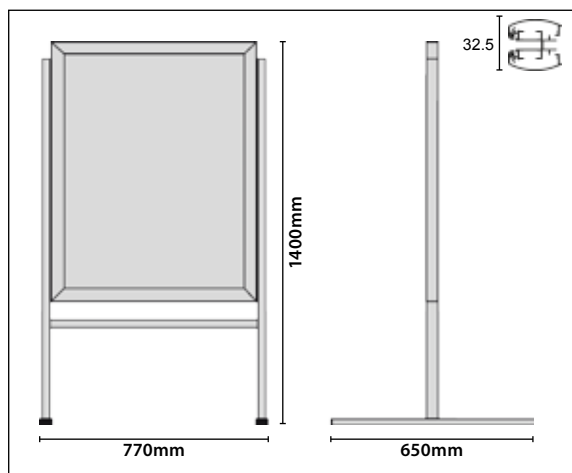

Revolving snapframe stand. Double sided poster stand for outdoor use, aluminium click frame, which swings back and forth in the wind.

**Material:** Aluminium, plastic parts.

	QTY	N.W(kg)	G.W(kg)	C.B.M.	Size(mm)
Packing	1	9.6	11.8	0.141	875x105x1535

10.165

700x1000mm



32mm

Tilting



## Almendralejo

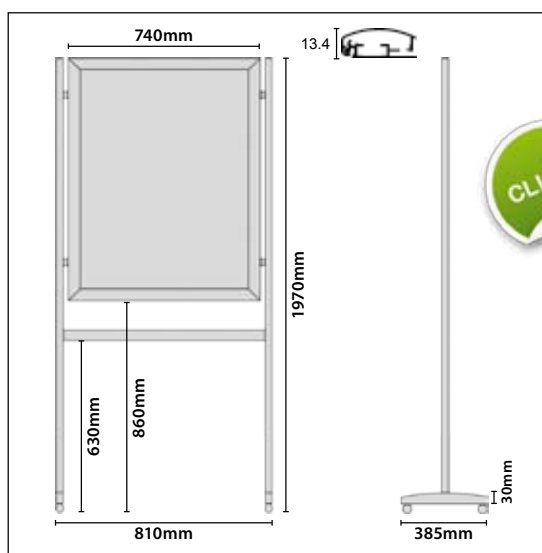

Poster stand with leaflet dispensers. For indoor use. One sided silver anodised aluminium click frame with rounded corners. Available with: 6 leaflet A6 or 4 leaflet A5 or 3 leaflet A4.

**Material:** Aluminium, plastic parts.

	QTY	N.W(kg)	G.W(kg)	C.B.M.	Size(mm)
Packing	1	7.5	12.1	0.125	860x75x1950

10.160

700x1000mm



Option 1  
A6  
x6

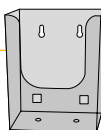

Option 2  
A5  
x4

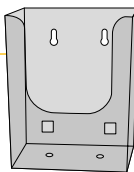

Option 3  
A4  
x3

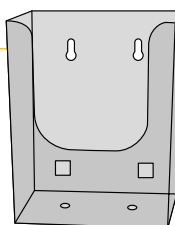

32mm



## Boal

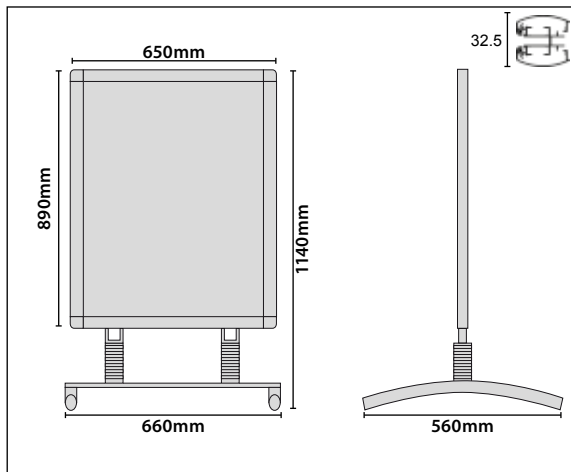

Double sided aluminium snapframe for indoor or outdoor use. Highly effective advertising combined with stability via spring attachment of board to base.

**Material:** Aluminium, steel, plastic parts.

10.166

605x860mm



## Hervas

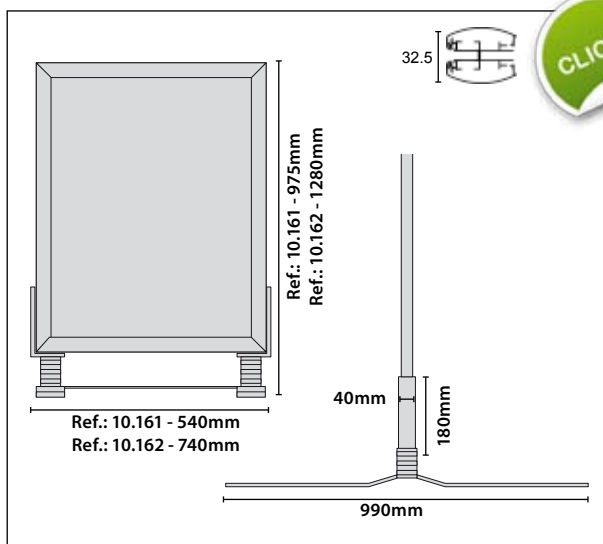

Poster stand. Highly effective advertising combined with stability via spring attachment of board to base. Sturdy steel and aluminium construction ensures durability of this two sided stand.

**Material:** Aluminium, steel, plastic parts.

10.161

500x700mm



10.162

700x1000mm



## Arcachón

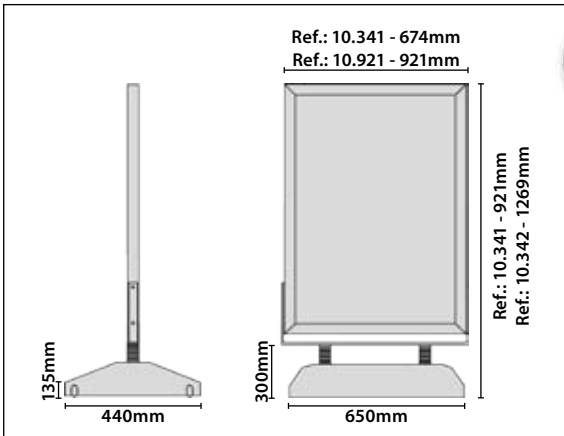

42mm

17 kgs Water



Double sided aluminium snapframe for indoor or outdoor use. Highly effective advertising combined with stability via spring attachment of water filled tank.

**Material:** Aluminium, steel, plastic parts.

10.341	A1		
10.342	A0		
10.115	500x700mm		
10.116	700x1000mm		

## Serradilla

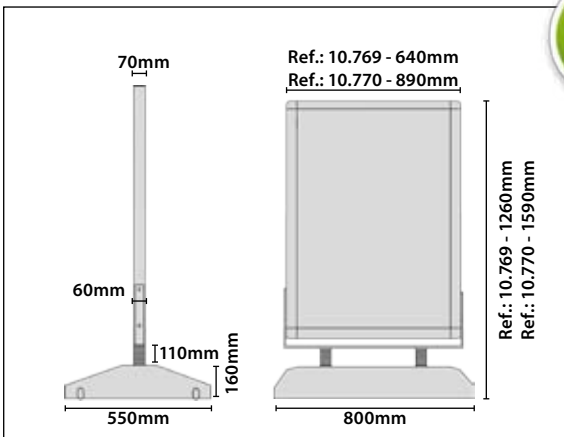

17-35 kgs Water



Wind Resistant. A0, A1 portrait snapframe. Weather resistant, spring loaded outdoor display. Base fills with water for stability and has integrated rollers for easy transportation. Rounded chrome finish corners. Brushed aluminium snapframe.

**Material:** Aluminium, steel, plastic parts.

10.769	A1	35 Kgs water		
10.770	A0	35 Kgs water		
10.164	A1	17 Kgs water		



## Mota

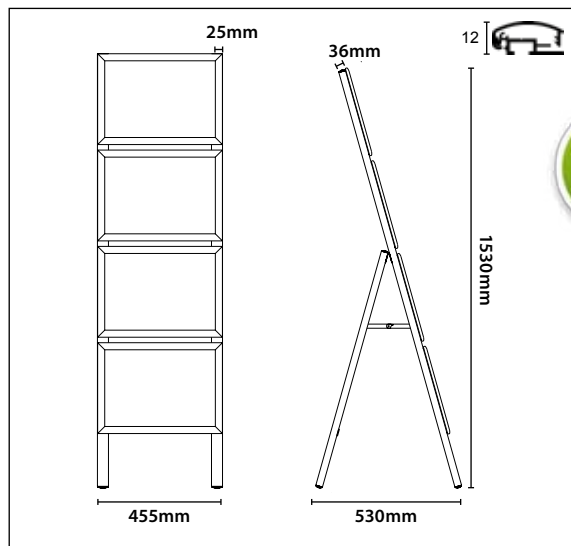

Poster aluminium stand one sided high quality silver anodised aluminium stand with 4 frames.

**Material:** Anodised aluminium.

10.216

A3



25mm

## Guadalupe

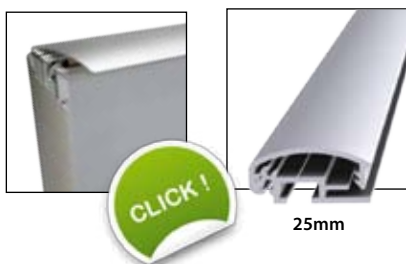

Poster "click" aluminium stand. One or two sided with 3 (A3) or 4 (A4) frames, aluminium click frame with silver anodised profile and UV - stabilised anti-reflective sheet.

**Material:** Aluminium, steel, plastic parts.

	QTY	N.W(kg)	G.W(kg)	C.B.M.	Size(mm)	
Packing	1	2.8	3.6	0.012	80x80x1920	x2
		9.55	10	0.015	465x465x72	
10.154		A4				
10.155		A3				
Packing	1	2.8	3.6	0.012	80x80x1920	x2
		9.55	10	0.015	465x465x72	
10.156		A4				
10.157		A3				

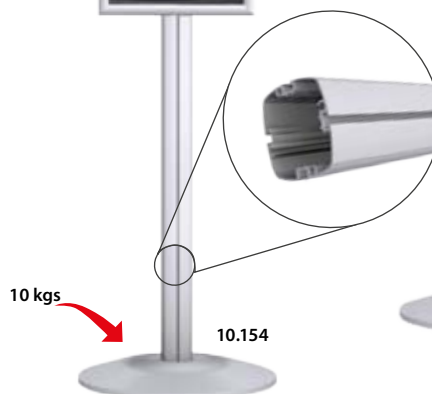
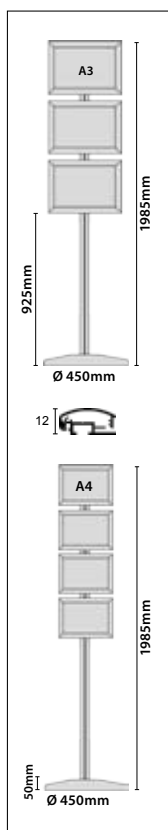

10.155

10.154

# ALUMINIUM FRAMES

3

## Plasencia



Poster "click" aluminium stand. One or two sided, aluminium click frame with silver anodised profile and UV - stabilised antireflective sheet.

**Material:** Aluminium, steel, plastic parts.

	QTY	N.W(kg)	G.W(kg)	C.B.M.	Size(mm)	
<b>Packing</b>	1	2.8	3.6	0.012	80x80x1920	x2
		9.55	10	0.015	465x465x72	
<b>10.147</b>		<b>500x700</b>				
<b>10.148</b>		<b>700x1000</b>				
<b>Packing</b>	1	2.8	3.6	0.012	80x80x1920	x2
		9.55	10	0.015	465x465x72	
<b>10.151</b>		<b>500x700</b>				
<b>10.152</b>		<b>700x1000</b>				

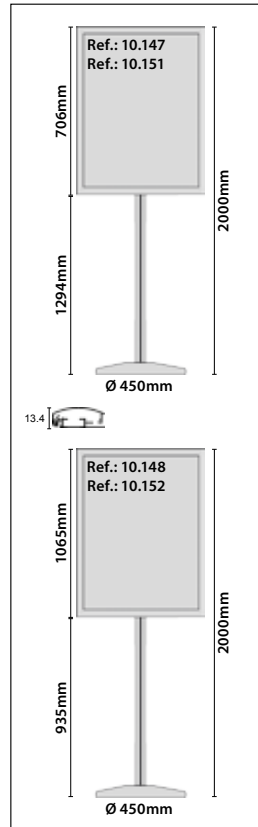

## Leinster

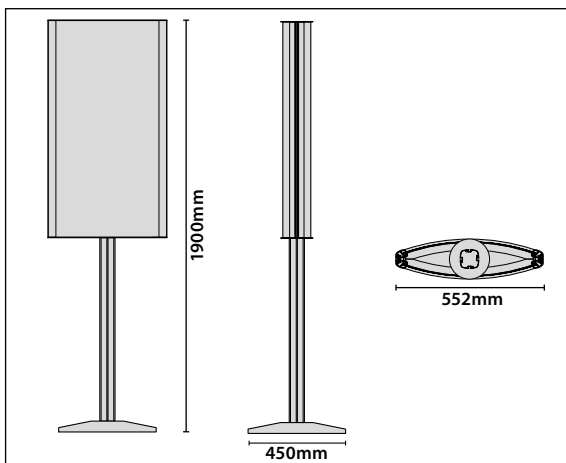

Double face display for indoor use. By the aid of snaps & hinged cover, one can easily change the poster on both sides. Brochure shelves can be added. Convex elegant look at eye-level to present your message.

**Material:** Aluminium, steel, plastic parts.

<b>10.980</b>		<b>500x700mm</b>				
<b>10.979</b>		<b>500x1000mm</b>				
<b>10.940</b>		<b>500x700mm</b>				
<b>10.941</b>		<b>500x1000mm</b>				



## Miravalles

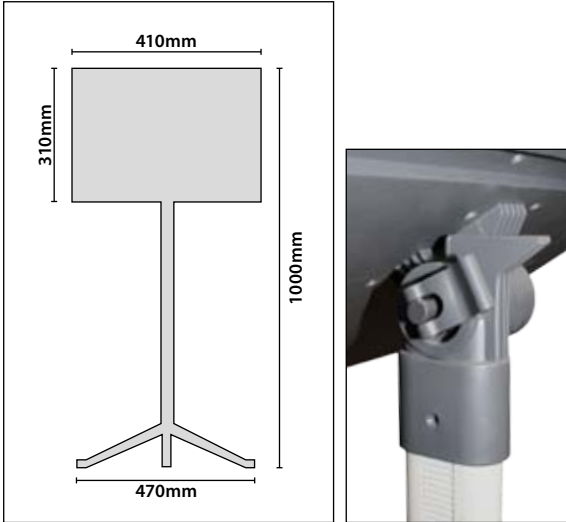

Extendible lectern for catalogues. Adjustable in height from 600mm to 900mm. Adjustable in angle from 0° to 90°. Height: 875mm.

**Material:** Aluminium, plastic.

10.052



## Solana

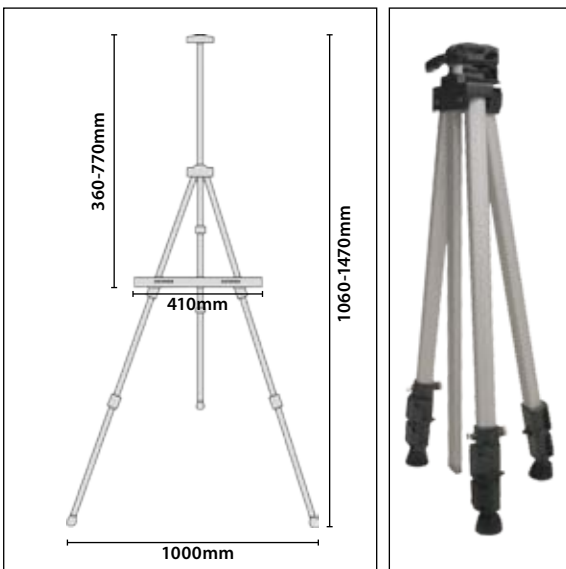

Adjustable tripod support frame. Metal adjustable tripod easel. Bottom tray for boards, panels, frames.

**Material:** Aluminium, plastic.

10.816

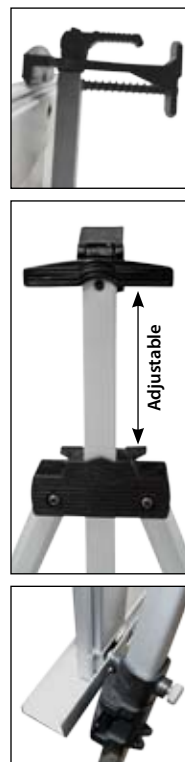

# MENU BOARD

3

## Zafra



Menu board. Available in A3 and A4 sizes both in landscape and portrait positions. Plastic base.

**Material:** Aluminium, plastic parts.

	QTY	N.W(kg)	G.W(kg)	C.B.M.	Size(mm)
Packing	1	0.75	0.85	0.0047	930x85x60
		1.65	1.76	0.0034	355X275X35



10.158                      A4                     

10.159                      A3                     



## Ulster

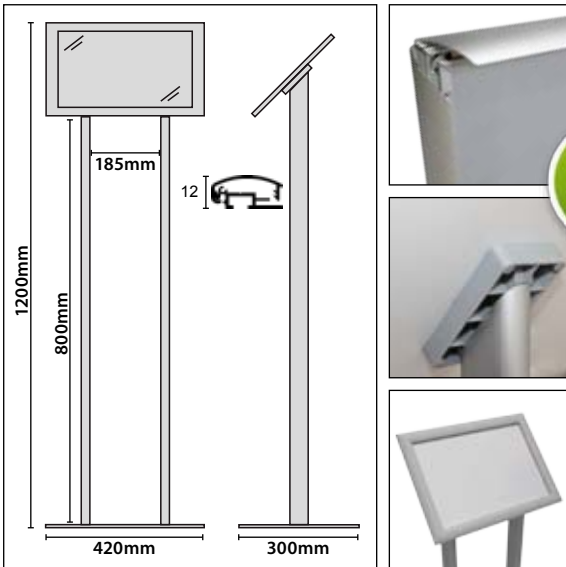

Menu board. Available in A3 size in landscape position. Plastic base.

**Material:** Aluminium, plastic parts.

	QTY	N.W(kg)	G.W(kg)	C.B.M.	Size(mm)
Packing	2	5	5.3	0.006	480x365x35
		2.15	2.5	0.010	1170x145x60



10.982                      A3                     



25mm

## Sligo



10.983



10.984

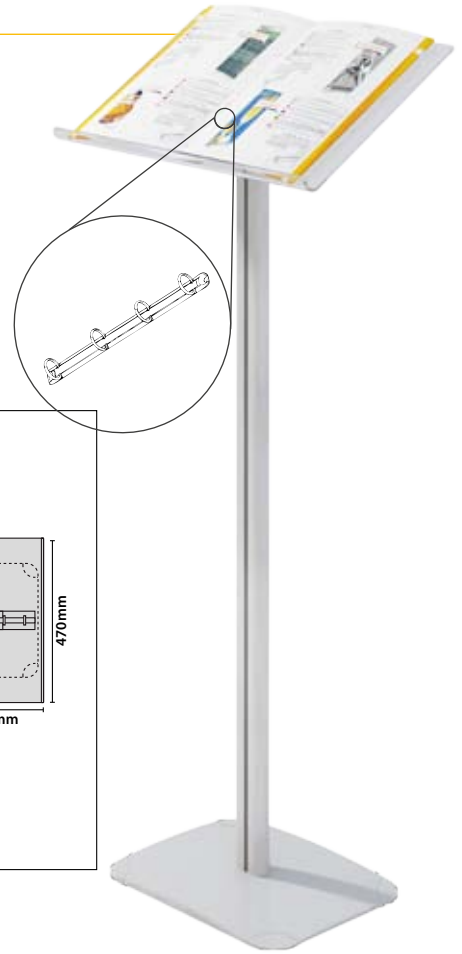

Folder Menuboard with its transparent acrylic or metallic self. With a ring binder available to hold 2x A4 individual menu pages. With the usage of the channeled alips profile any acrylic or steel shelf, even a frame can let the product have advantages.

**Material:** Aluminium, plastic parts.



	QTY	N.W(kg)	G.W(kg)	C.B.M.	Size(mm)
<b>Packing</b>	1	4.3	4.7	0.010	500x330x65
		1.15	1.3	0.002	1070x65x40

**10.984**      **Metalic**

<b>Packing</b>	1	2.75	3	0.010	500x330x65
		1.15	1.3	0.002	1070x65x40

**10.983**      **Acrylic**

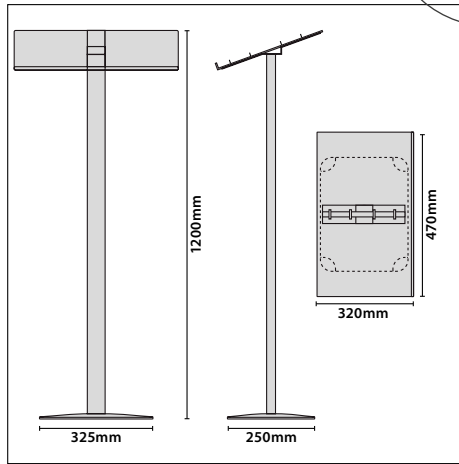

## Tomar



Allows signage to be displayed either portrait or landscape. Holds signage up to 8 1/2" W x 11" H (216 x 279mm). Rear pocket holds additional literature. Clear magnetic sign panel makes signage changes easy. No tools required for assembly. Weighted steel base.

**Material:** Aluminium, steel, plastic parts.

**13.102**      **216x279mm**

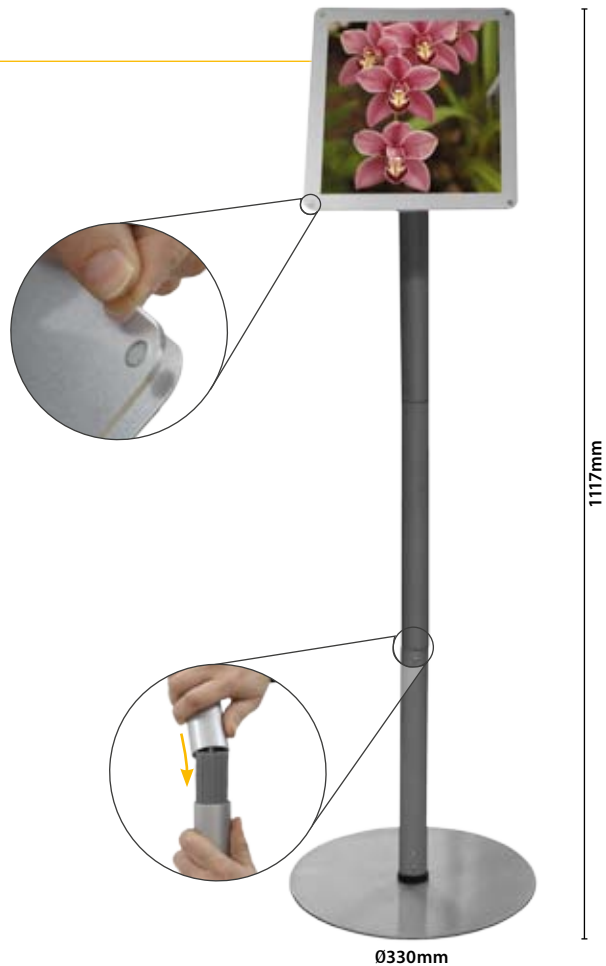

# MENU BOARD

3

## Combi

Diferent possibility for aluminium stand. Easy to assembly.

**Material:** Aluminium, steel, plastic parts.

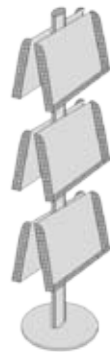
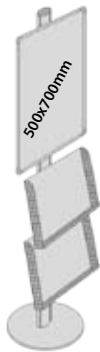
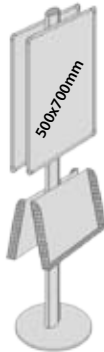
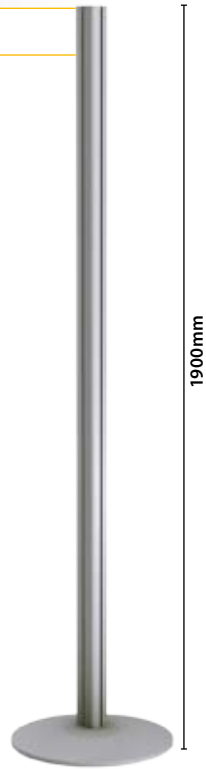
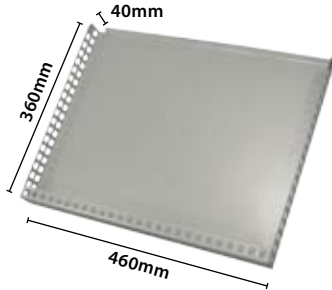

10.479 Combi One - 1

10.480 Combi One - 2

10.485 Combi Two - 1

10.486 Combi Two - 2

10.483 Combi Three - 1

10.484 Combi Three - 2

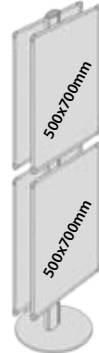

10.481 Combi Four - 1

10.482 Combi Four - 2

10.487 Combi Mix - 1

10.488 Combi Mix - 2

10.489 Combi Frame - 1

10.490 Combi Frame - 2

## Melgar

Showcard stand, can exhibit one or two graphics vertical or horizontal.

**Material:** Aluminium, plastic parts.

12



25mm

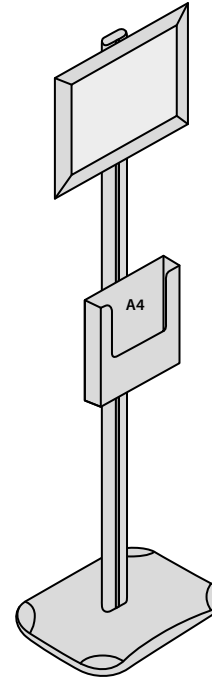
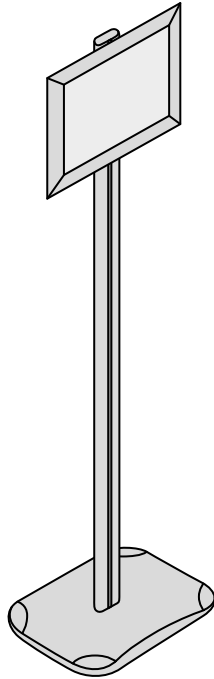

10.344      A4     

10.579      A3     

10.349      A4      x1 - A4     

10.583      A3      x1 - A4     

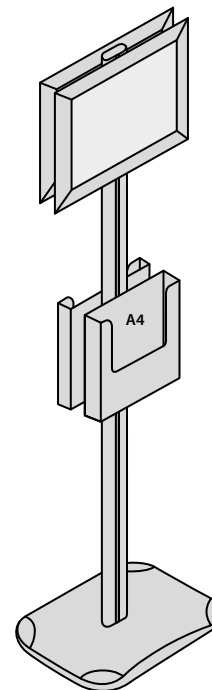
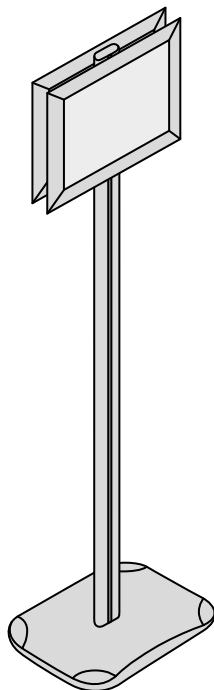

10.345      A4     

10.580      A3     

10.549      A4      x2 - A4     

10.584      A3      x2 - A4

## Kerry

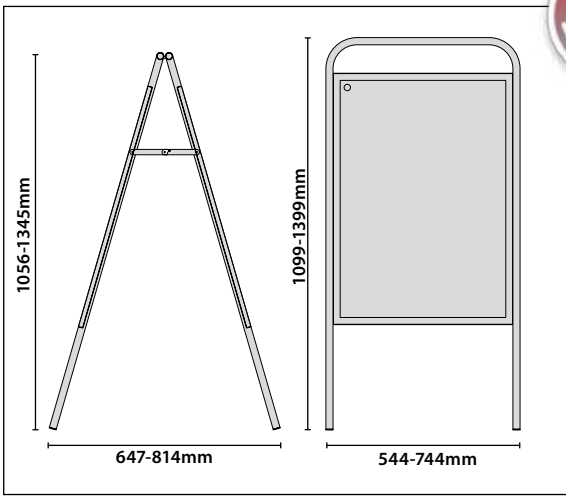

Stable & heavy pavement sign, used double sided. There is a magnetic cover placed over the poster. Suitable for crowded, outdoor public areas. Round steel tubing.

**Material:** Steel, plastic. **Colour:**

**10.691**      **500x700mm**     

**10.692**      **700x1000mm**     

## Cork

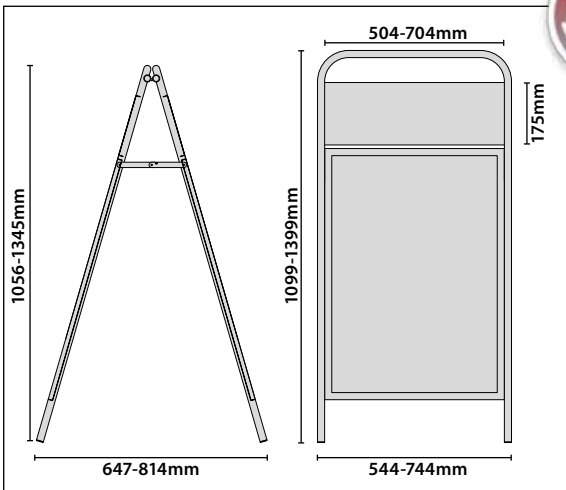

Stable & heavy pavement sign, used double sided. There is a magnetic cover placed over the poster. Suitable for crowded, outdoor public areas. Round steel tubing.

**Material:** Steel, plastic. **Colour:**

**10.695**      **500x700mm - 175x504mm**     

**10.696**      **700x1000mm - 175x704mm**



## Monaghan

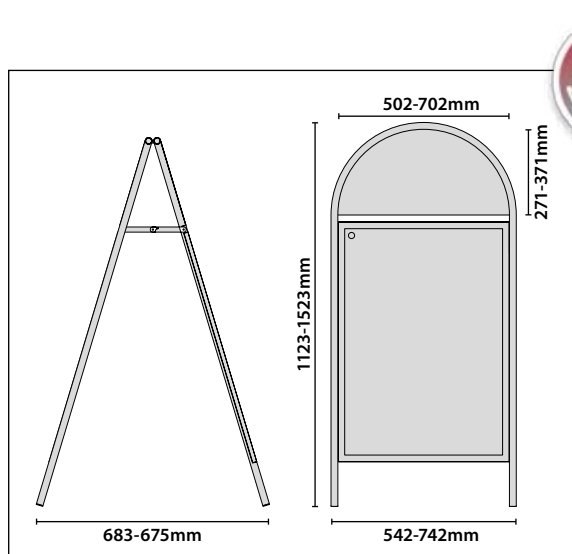

Stable & heavy pavement sign, used double sided. There is a magnetic cover placed over the poster. Suitable for crowded, outdoor public areas. Round steel tubing.

**Material:** Steel, plastic.

**Colour:**

**10.699** 500x700mm - 256x514mm



**10.700** 700x1000mm - 357x714mm



## Lifford

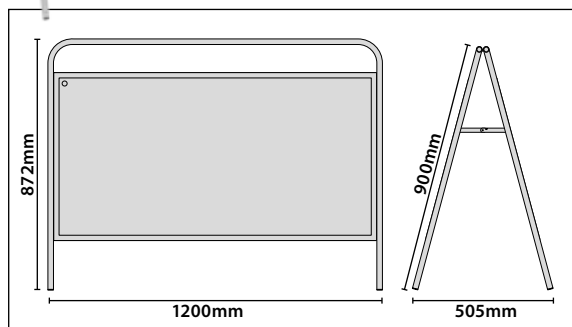

Stable & heavy pavement sign, used double sided. There is a magnetic cover placed over the poster. Suitable for crowded, outdoor public areas. Round steel tubing.

**Material:** Steel, plastic.

**Colour:**

**10.701** 1156x600mm

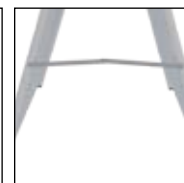

## Outdoor Poster Stand



Outdoor poster stand. Double sided stand steel profile. Available in six different colours.

**Material:** Steel.

10.167	600x1000mm		
10.168	Whiteboard - 590x995mm		

## Dover

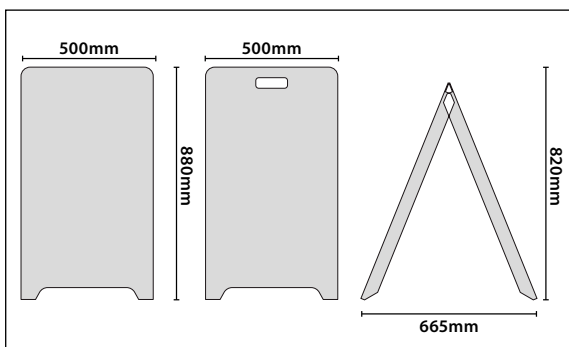

Simple plastic pavement board for all kind of purpose. Approximate visual area is 500x700mm. PS display is suitable for inkjet printing and adhesive folio. Easy to move and store. Can be delivered with black chalkboard for writing with chalkpen.

**Material:** PVC.



	QTY	N.W(kg)	G.W(kg)	C.B.M.	Size(mm)
Packing	1	1.5	2.1	0.025	885x520x55

13.129	480x815mm	
13.130	480x815mm	
13.131	Blackboard - 480x815mm	

## Évora

LED light box. They can stand or hanging vertical or horizontal. Silver or black plastic frame for A4 and A3. B6 colour silver. AC power supply included.



**Material:** Plastic.

10.240	<input type="checkbox"/>	B6		
10.242	<input type="checkbox"/>	A4		
10.243	<input checked="" type="checkbox"/>	A4		
10.244	<input type="checkbox"/>	A3		
10.245	<input checked="" type="checkbox"/>	A3		



## Pavia



Alu light box single side. With clamp profile, silver anodised. Included cable and plug.

**Material:** Aluminium, plastic parts.

10.246	<input type="checkbox"/>	A4		
10.247	<input type="checkbox"/>	A3		



## Lisboa



Alu light box, single or double sided. With clamp profile, silver anodised. Includes cable and plug. Excellent distribution of light, no hot spot.

**Material:** Aluminium, plastic parts.

10.200	<input type="checkbox"/>	700x1000mm		
10.201	<input type="checkbox"/>	500x700mm		
10.763	<input type="checkbox"/>	700x1000mm		
10.764	<input type="checkbox"/>	500x700mm		



# LIGHT BOX

3

## Durango



LED light box. Silver colour. AC power supply included.

**Material:** Plastic.

13.181

A4

1.2 Kg



## Yucatán

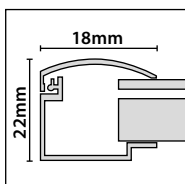

LED light box. With clamp profile, silver anodised aluminium. AC power supply included.

**Material:** Aluminium, plastic parts.

13.207

A0

10.2 Kg



13.208

A1

5.2 Kg



13.209

A2

2.7 Kg



13.210

A3

1.7 Kg



13.211

A4

0.75 Kg



## Artega

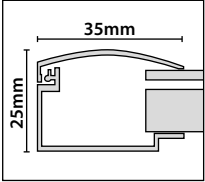

Aluminium light box single side. Clamp profile, silver anodised. Includes AC power supply.

**Material:** Aluminium, plastic parts.

13.202	A0	15.8 Kg		
13.203	A1	9.3 Kg		
13.204	A2	6.2 Kg		
13.205	A3	3.5 Kg		
13.206	A4	2.5 Kg		

## Tepic

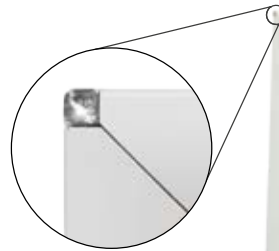
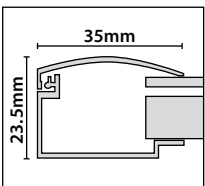

Aluminium light box single side. Clamp profile, silver anodised. Includes AC power supply.

**Material:** Aluminium, plastic parts.

13.182	A0	17 Kg		
13.183	A1	10 Kg		
13.184	A2	7 Kg		
13.185	A3	4 Kg		
13.186	A4	3 Kg		

# LIGHT BOX

3

## Campeche

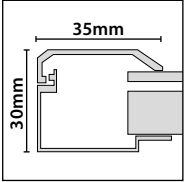

Includes clamp profile. Poster or sheets are protected by a thin laminated plastic for a quality look. AC power supply included.

**Material:** Aluminium, plastic parts.

13.217	A0	21.2 Kg		
13.218	A1	12.2 Kg		
13.219	A2	7.7 Kg		
13.220	A3	4.3 Kg		
13.221	A4	2.9 Kg		

## Nogales

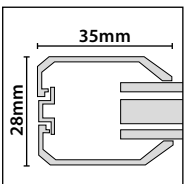

Aluminium light box double side. Clamp profile, silver anodised. Includes AC power supply.

**Material:** Aluminium, plastic parts.

13.190	A0	17.7 Kg		
13.191	A1	10.4 Kg		
13.192	A2	6.9 Kg		
13.193	A3	4.7 Kg		
13.194	A4	2.8 Kg		

## Quintin

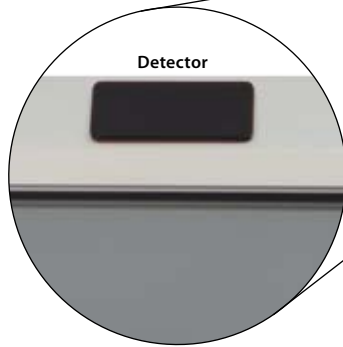
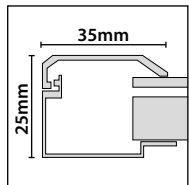

Aluminium light/mirror light box. The frame stays lit up when the presence detector is transformed into a mirror.

**Material:** Aluminium, plastic parts.

13.198	A0	15.8 Kg		
13.199	A1	9.3 Kg		
13.200	A2	7.5 Kg		
13.201	A3	4.1 Kg		

## Jalisco

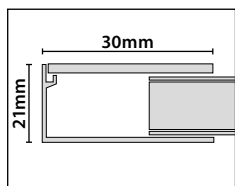

LED light box magnetic system open. Easy and quick to change graphics. Black border and aluminium frame.

**Material:** Aluminium, plastic parts.

13.212	A0	21 Kg		
13.213	A1	13 Kg		
13.214	A2	10 Kg		
13.215	A3	4 Kg		
13.216	A4	3 Kg		

# LIGHT BOX

3

## Tampico



The Tampico LED light outdoor box is shown in an open state, revealing its internal components. A close-up inset shows the hinge mechanism. A technical drawing indicates a depth of 48mm and a height of 38mm. A 'WATERPROOF' icon with an umbrella symbol is present. A 'Technology LED!' badge is also shown. The main image displays the box with a landscape photograph of a mountain valley.

LED light outdoor box. Easy and quick to open. AC power supply included.

**Material:** Aluminium, plastic parts.

13.195	A0	15.8 Kg		 
13.196	A1	9.3 Kg		 
13.197	A2	6.2 Kg		 

## Belize



The Belize LED light outdoor box is shown with a hand opening the door. A close-up inset shows the hinge mechanism. A technical drawing indicates a depth of 78mm and a height of 50mm. A 'WATERPROOF' icon with an umbrella symbol is present. A 'Technology LED!' badge is also shown. The main image displays the box with a close-up photograph of a lion's face.

LED light outdoor box. Resistant and elegant frame system. AC power supply included.

**Material:** Aluminium, plastic parts.

13.187	A0	39.3 Kg		 
13.188	A1	21.6 Kg		 
13.189	A2	12.3 Kg		 



## Totem Wall Light Box Genova

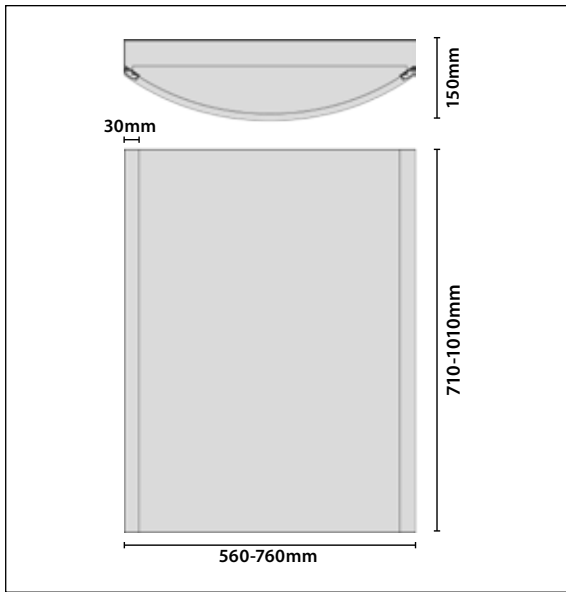

Single sided lightbox it has a click/snap system for fast and easy exchange of graphic.

**Material:** Aluminium, plastic parts.

10.117	500x700mm		
10.348	700x1000mm		

## Obidos

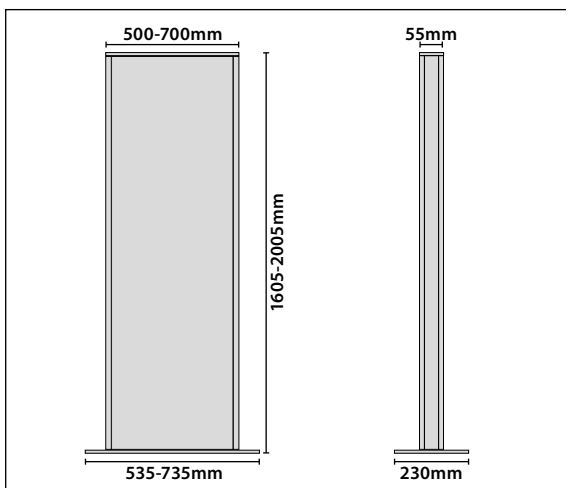

Curved lightbox. Profile double sided totem with durable aluminium frame. The interior of the totem contains all the electric and fluorescent system. A metallic base allows you to place boards whenever you like such as hallways, building, hotels.

**Material:** Aluminium, steel, plastic parts.

10.221	500x1600mm		
10.222	600x1800mm		
10.223	700x2000mm		



## Nantes



Double face curved lightbox it has a click/snap system for fast and easy exchange of graphic metal frame and steel base.

**Material:** Aluminium, steel.

	QTY	N.W(kg)	G.W(kg)	C.B.M.	Size(mm)
<b>Packing</b>	1	22.8	24	0.399	1660x660x365

<b>10.464</b>	<b>500x1600mm</b>		
---------------	-------------------	--	--

<b>Packing</b>	1	27	28.5	0.551	1860x760x390
----------------	---	----	------	-------	--------------

<b>10.465</b>	<b>600x1800mm</b>		
---------------	-------------------	--	--

<b>Packing</b>	1	30.4	32	0.751	1860x860x470
----------------	---	------	----	-------	--------------

<b>10.556</b>	<b>700x1800mm</b>		
---------------	-------------------	--	--

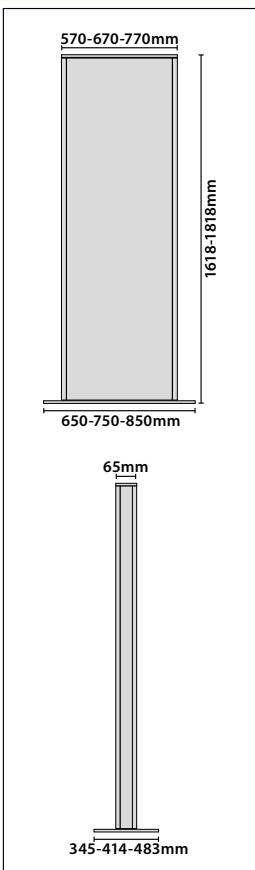

## Cascais

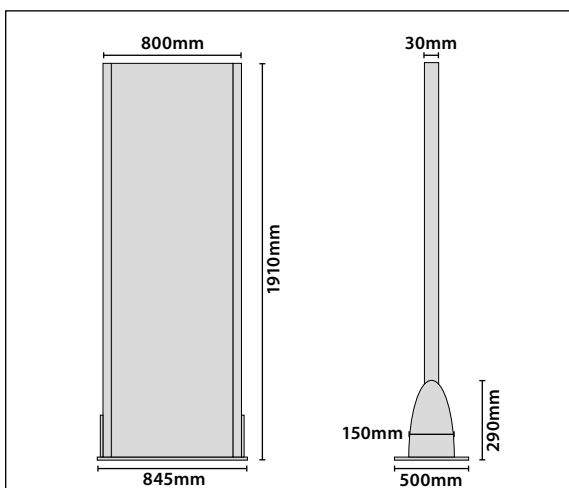

Straight, profile double sided totem with durable aluminium snap frame. Available with light.

**Material:** Aluminium, steel, plastic parts.

<b>10.354</b>	<b>700x1900mm</b>		
---------------	-------------------	--	--

<b>10.356</b>	<b>700x1900mm</b>		
---------------	-------------------	--	--



## Sintra

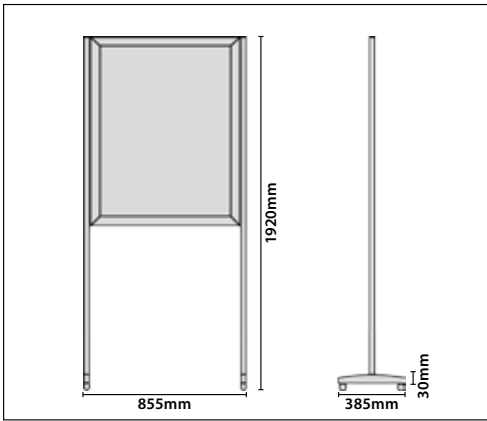

Alu light box, single or double sided. With clamp profile, silver anodised.

**Material:** Aluminium, acrylic.

	QTY	N.W(kg)	G.W(kg)	C.B.M.	Size(mm)
Packing	1	17	20	0.155	940x85x1950

**10.765**      **700x1000mm**



Packing	1	18.4	21.5	0.155	940x85x1950
---------	---	------	------	-------	-------------

**10.767**      **700x1000mm**



## Blasimón

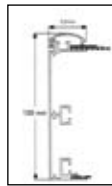
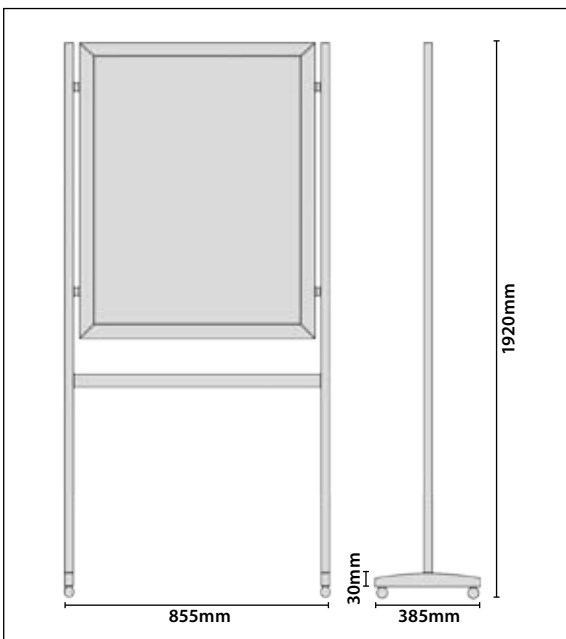

32mm



Alu light box, with castors. With clamp profile, silver anodised.

**Material:** Aluminium, plastic parts.

13.4

**10.567**      **700x1000mm**



## Sagres



Brochure stand for A4 brochures made with a heavy foot. The shelf is made of strong Polycarbonate or Steel. Height: 1000mm.

**Material:** Aluminium, acrylic.

	QTY	N.W(kg)	G.W(kg)	C.B.M.	Size(mm)
Packing	1	2.9	3.6	0.032	910x295x120

**10.473 Acrylic**

	QTY	N.W(kg)	G.W(kg)	C.B.M.	Size(mm)
Packing	1	2.4	3.45	0.032	910x295x120

**10.474 Steel**

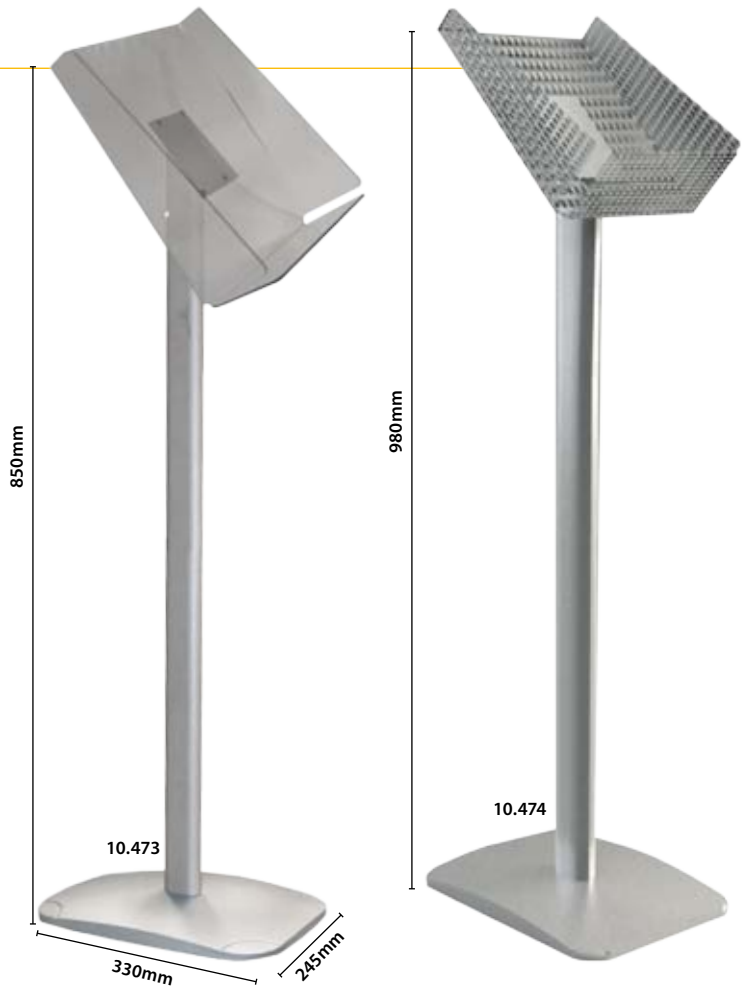

## Bari

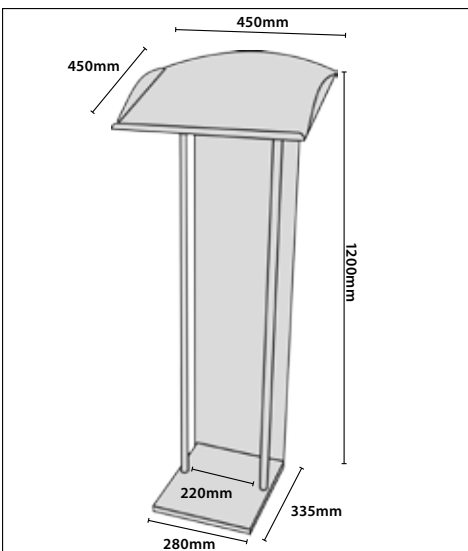

Catalogue display for A4 portrait brochures. Colour: Grey.

**Material:** Steel.

	QTY	N.W(kg)	G.W(kg)	C.B.M.	Size(mm)
Packing	1	8.6	11	0.312	500x500x1250

**10.219**



## Vegas



Foldable brochure stand. Lightweight design. 4 x A4 clear acrylic portrait pockets.

**Material:** Steel, acrylic.

**10.048**      **Height: 1550mm**     

## Sahagun



Foldable brochure stand. Lightweight design in aluminium. Quick and easy to unfold. Includes alu suitcase. Available in acrylic or wood.

**Material:** Aluminium, steel, acrylic, wood.

**10.047**      **Acrylic - Height: 1500mm**     

**10.974**      **Wood - Height: 1500mm**     

## Soubran



Folding brochure stand, steel structure, five A4 shelves. The bottom can be use to place a graphic.

**Material:** Steel.

**10.416**      **Height: 1420mm**     

## Lorca



Folding brochure stand, 4 x A4 shelves. The bottom can be use to place a graphic. Available in 3 differents colours.

**Material:** Steel, acrylic, plastic.

**10.669**             **Height: 1420mm**     

**10.670**             **Height: 1420mm**     

**10.671**             **Height: 1420mm**

## Legnica



Foldable brochure stand. Lightweight design in steel and plastic.

**Material:** Steel, plastic.

10.114



## LCD Torun



Foldable LCD brochure stand. 4 x A4 shelves. Includes a high brightness color 7" LCD screen.

**Material:** Aluminium, plastic.

10.149



## Mentrida

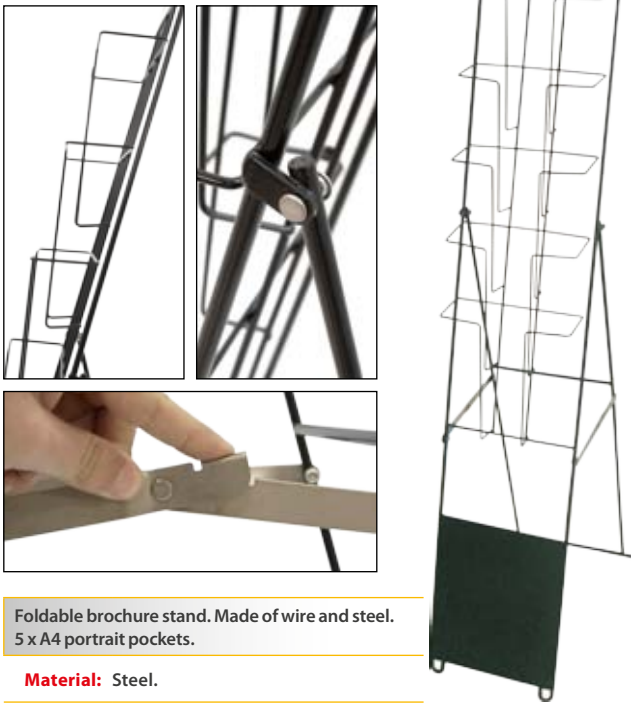

Foldable brochure stand. Made of wire and steel. 5 x A4 portrait pockets.

**Material:** Steel.

**10.720**      **Height: 1460mm**

## Bañeza



Brochure stand. Made of wire and steel. It has seven portrait pockets, size A4.

**Material:** Steel.

**10.044**      **280x1360mm**

## Sil

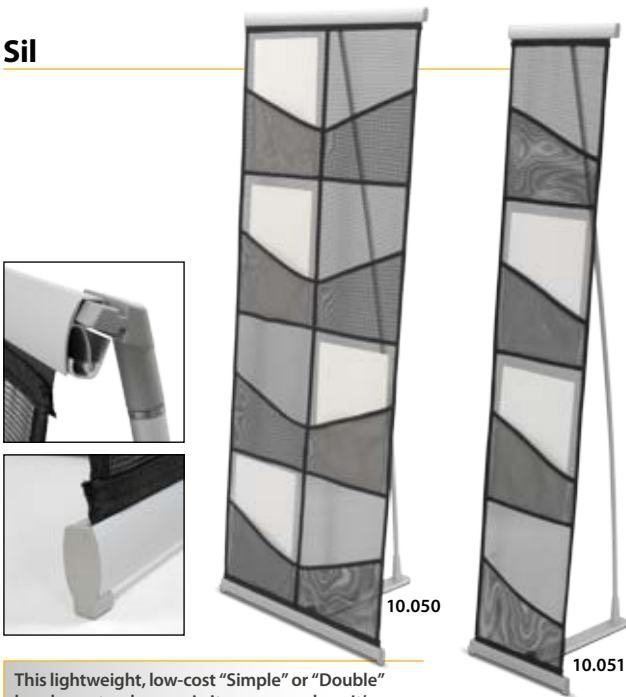

This lightweight, low-cost "Simple" or "Double" brochure stand comes in its own carry bag. It's easy to erect and very lightweight so carrying to and from exhibition is no problem. Height: 1360mm.

**Material:** Aluminium, steel, acrylic, wood.

**10.050**      **Double**

**10.051**      **Single**



## Nelas



Wire brochure holder with wheels. Shape: A4.

**Material:** Steel, plastic.

**13.101**      **1400mm**

## Verona

Brochure stand with four A4 acrylic shelves with a width of 275mm. For 4x A4 (10.217) or 12x A4 (12.218). Includes rotating wheels, easy to assemble. Size: 340x1665x380mm (10.217) - 815x1665x380mm (10.218).

**Material:** Aluminium, acrylic, plastic parts.

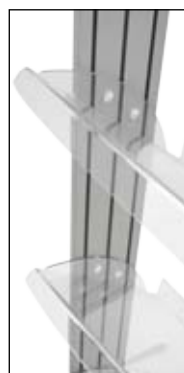

	QTY	N.W(kg)	G.W(kg)	C.B.M.	Size(mm)
Packing	1	3	3.95	0.030	430x420x170
		4.45	5	0.018	145x80x1620



10.217

147x255mm

\* Printing

	QTY	N.W(kg)	G.W(kg)	C.B.M.	Size(mm)
Packing	1	6.8	7.85	0.071	900x430x185
		4.45	5	0.018	145x80x1620



10.218

147x730mm

\* Printing

## Athy

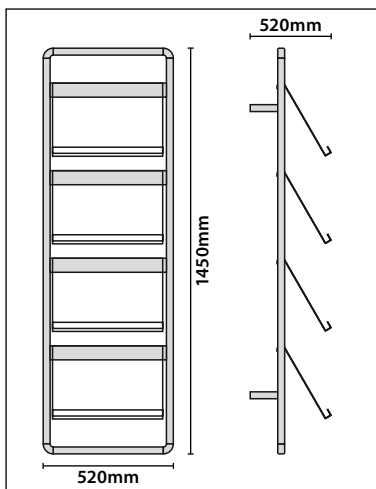

Wall-Mounted leaflet dispenser. Used for 8 x A4.

**Material:** Aluminium, acrylic.

10.988



## Cañamo

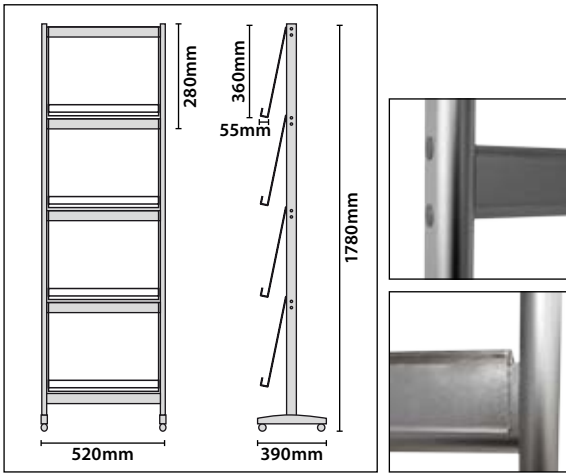

Single side brochure stand. Designed for 8 x A4 brochures. The legs are made of aluminium. Size: 620x1770x390mm.

**Material:** Aluminium, acrylic.

	QTY	N.W(kg)	G.W(kg)	C.B.M.	Size(mm)
Packing	1	7.3	9	0.048	410x165x720
		6.45	8.05	0.077	630x70x1750



10.468



## Abad

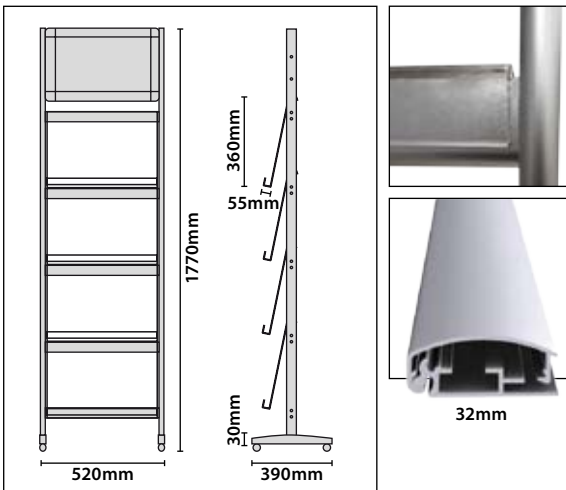

Single side brochure stand with "click" frame. Designed for 8 x A4 brochures. The legs are made of aluminium. Size: 620x1770x390mm.

**Material:** Aluminium, acrylic.

	QTY	N.W(kg)	G.W(kg)	C.B.M.	Size(mm)
Packing	1	7.3	9	0.048	410x165x720
		6.45	8.05	0.077	630x70x1750



10.467

460x260mm  
\*Printing



# BROCHURE STAND

3

## Sotillo

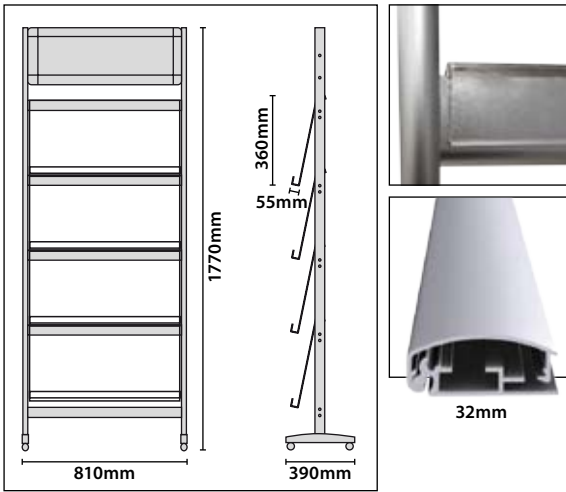

Single side brochure stand with "click" frame. Designed for 12 x A4 brochures. The legs are made of aluminium. Size: 810x1770x390mm.

**Material:** Aluminium, acrylic.

	QTY	N.W(kg)	G.W(kg)	C.B.M.	Size(mm)
Packing	1	9	10.5	0.062	410x165x920
		7.35	9.35	0.101	830x70x1750



10.469

675x195mm

\* Printing

## Olmedilla

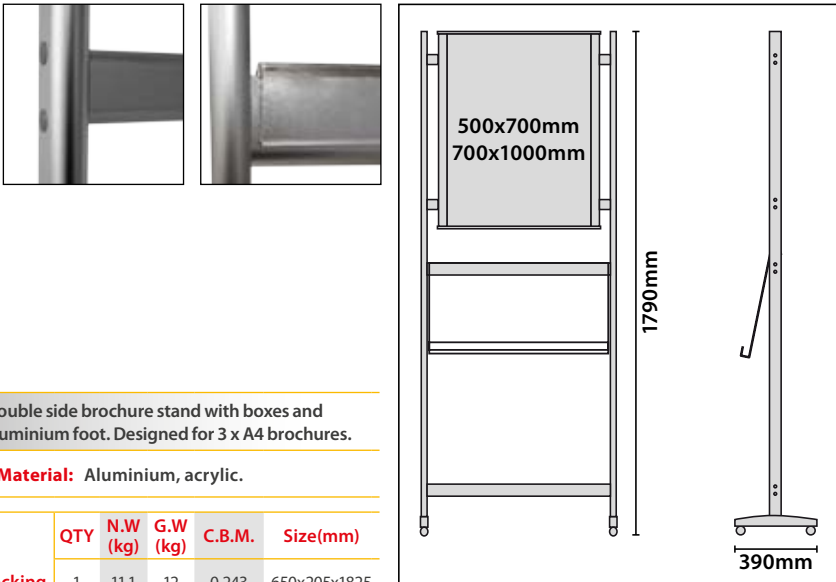

Double side brochure stand with boxes and aluminium foot. Designed for 3 x A4 brochures.

**Material:** Aluminium, acrylic.

	QTY	N.W (kg)	G.W (kg)	C.B.M.	Size(mm)
Packing	1	11.1	12	0.243	650x205x1825

10.472

500x700mm



	QTY	N.W (kg)	G.W (kg)	C.B.M.	Size(mm)
Packing	1	17	18.5	0.372	850x240x1825

10.273

1000x700mm



## Alar

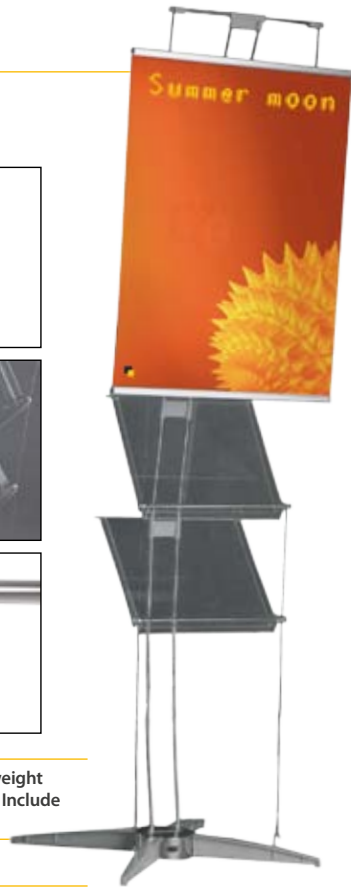
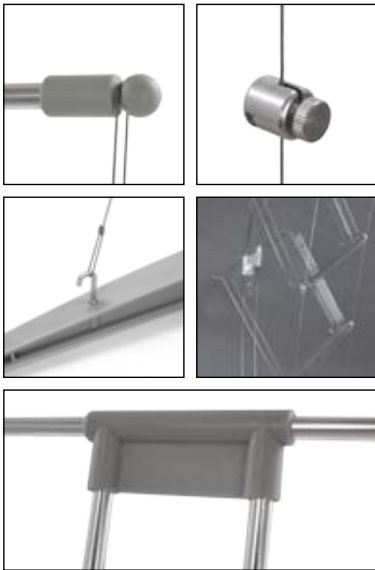

Foldable brochure stand one side. Lightweight design with clear acrylic portrait pockets. Include nylon carry bag.

**Material:** Aluminium, acrylic.

10.771

600x800mm



## Mansilla

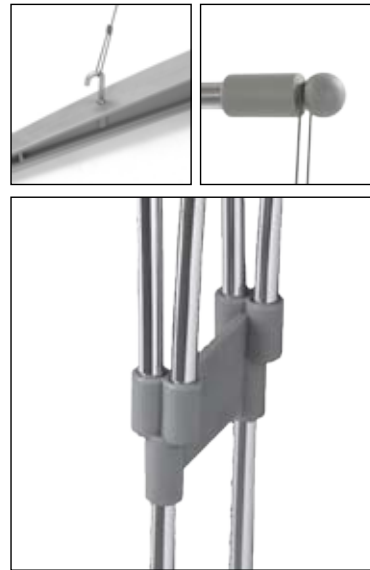

Foldable brochure stand double side. Lightweight design with clear acrylic portrait pockets. Include nylon carry bag.

**Material:** Aluminium, acrylic.

10.772

600x800mm x2



## Cañada

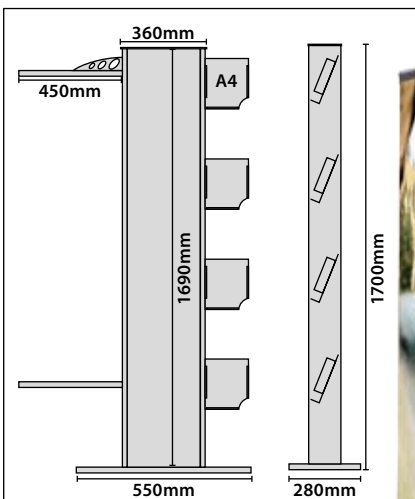

Double side brochure stand with lightboxes and poster clamp. Designed for 4 x A4 brochures. Size: 820x1700x280mm.

**Material:** Aluminium, steel, acrylic.

	QTY	N.W (kg)	G.W (kg)	C.B.M.	Size(mm)
Packing	1	18.5	19.7	0.375	625x345x1740

10.470

Totem 324x1685mm  
Poster 430x1100mm



## Hito

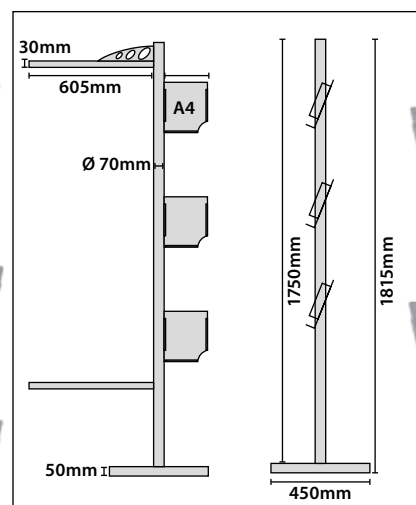

Single side brochure stand with lightboxes and poster clamp. Designed for 3 x A4 brochures. Size: 880x1815x450mm.

**Material:** Aluminium, steel, acrylic.

10.471

600x1500mm



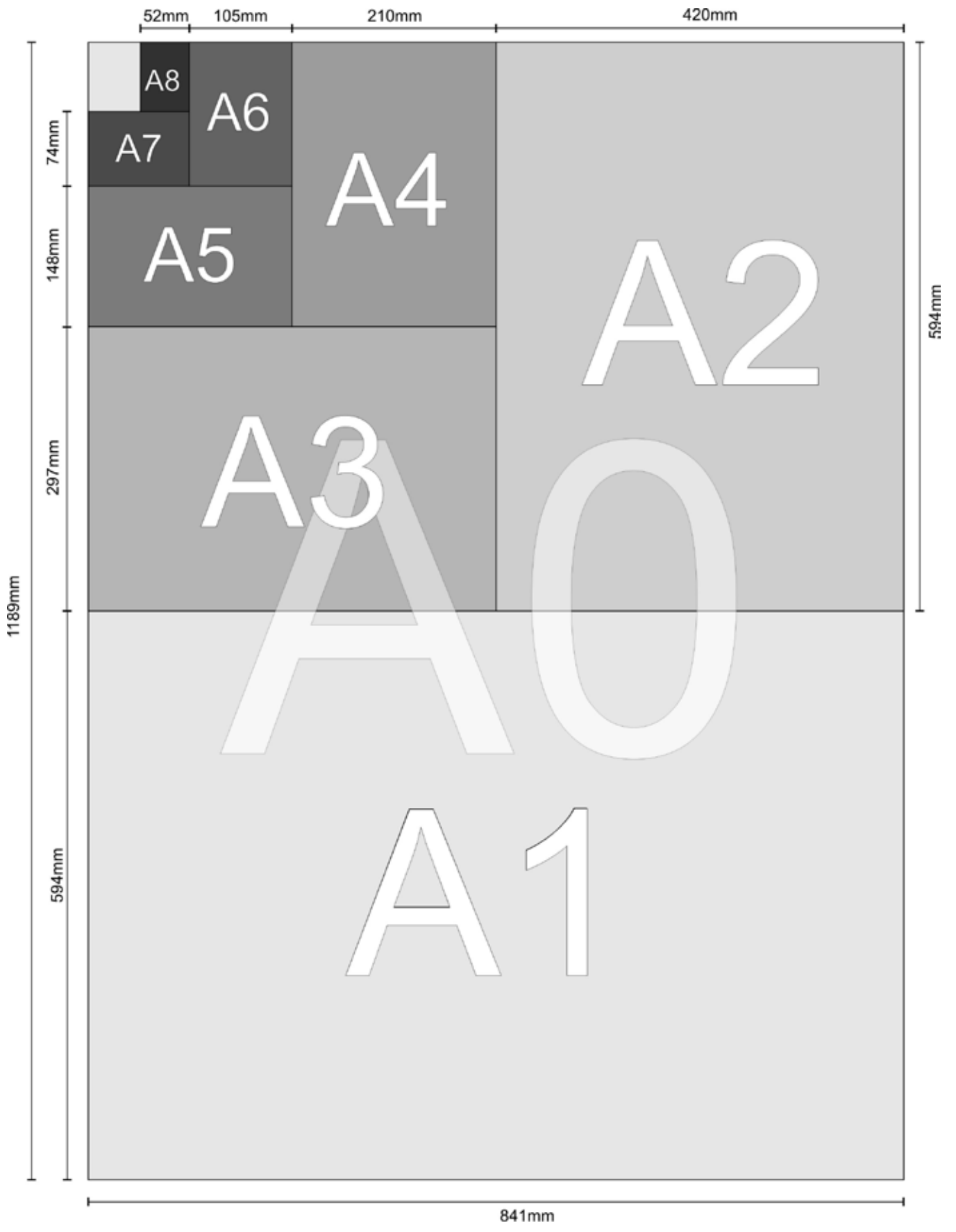



4

outdoor

## Steel Tent 2x2

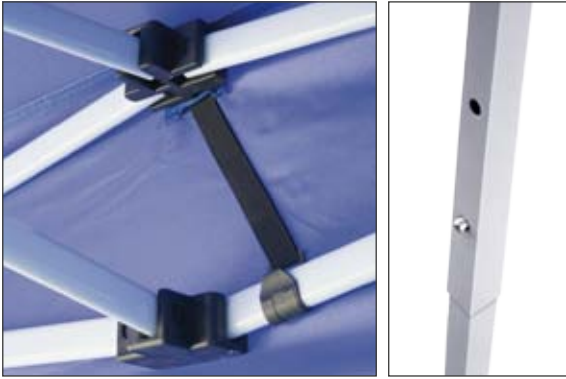

Promotional tent. Available in white, blue or red. Steel frame.

**Material:** Steel, plastic parts, fabric.

10.181

10.182

10.183  2000x2000mm



## Steel Tent 2x3



Promotional tent. Available in white, blue or red. Steel frame.

**Material:** Steel, plastic parts, fabric.

10.184

10.185

10.186  2000x3000mm



## Steel Tent 3x3



Promotional tent. Available in white, blue or red. Steel frame.

**Material:** Steel, plastic parts, fabric.

10.187

10.188

10.189

3000x3000mm

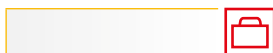

## Steel Tent 3x4,5



Promotional tent. Available in white, blue or red. Steel frame.

**Material:** Steel, plastic parts, fabric.

10.190

10.220

10.250

3000x4500mm

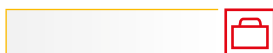

## Steel Tent 3x6

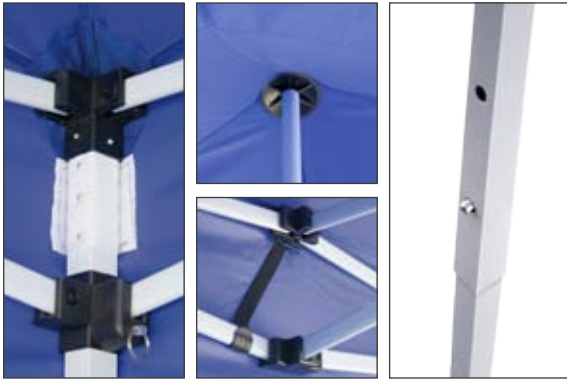

Promotional tent. Available in white, blue or red. Steel frame.

**Material:** Steel, plastic parts, fabric.

10.251

10.252

10.253

3000x6000mm



## Steel Tent 3x3



Promotional tent. Available in blue or red. Steel frame.

**Material:** Steel, plastic parts, fabric.

10.818

10.817

3000x3000mm





## Aluminium Tent



Promotional aluminium tent with side wall.

**Material:** Aluminium, plastic parts, fabric.



10.433	3000x3000mm	
10.434	3000x4500mm	



4

## Square Folder Table



Square folding table. Easy and fast to assemble.

**Material:** Aluminium.

10.814 700x700x700mm



## Round Table



Round folding table. Easy and fast to assemble.

**Material:** Aluminium and wood.

10.813 680x680x680mm



## Chair



Folding Chair.

**Material:** Aluminium, plastic parts.

10.815 450x450mm



## Air Dancer



6m

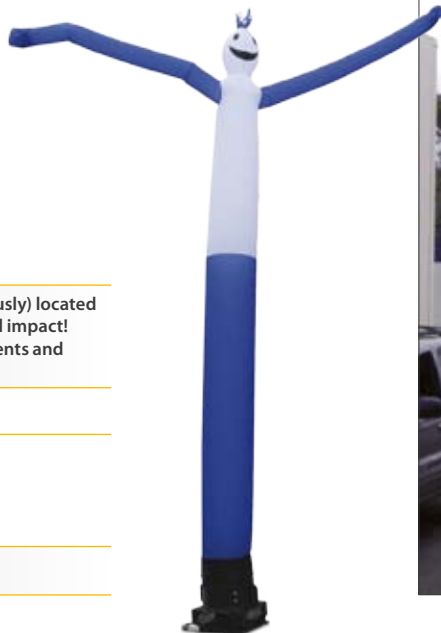

Air dancer; w/ electrical fan motor (pumps air continuously) located at the bottom. The flowing air makes it dance. Big visual impact! It also includes Velcro and extra cloth for any adjustments and set-up of the graphic.

**Material:** Fabric.

15.152

15.153

15.154   Ø 450x6000mm

## Light Tube 2300mm



2.3 m



Light tube; w/ electrical fan motor (pumps air continuously) located inside the tube. Use for any publicity display. Includes Velcro for fast and easy exchange of graphic.

**Material:** Fabric.

15.155

15.156  Ø 400x2300mm



## Inflatable Hut 5x5



5x5x3.9m



Inflatable Hut; w/ electrical motor (pumps air continuously) located on the exterior. The transparent door is hold-up by Velcro. Includes fasten strings and pins. Fast and easy to set-up.

**Material:** Fabric.

15.157  5000x5000x3900mm



## Inflatable Tent



Inflatable Auditorium Tent; w/ electrical motor (pumps air continuously) located on the exterior. The side walls can be taken-off or leave-on by means a zipper. Use it for any publicity event. Includes fasten strings and pins. Fast and easy to set-up!

**Material:** Fabric.

15.158

15.159  4250x4250x2900mm

15.160

15.161  6000x6000x4000mm



## Inflatable Auditorium Tent

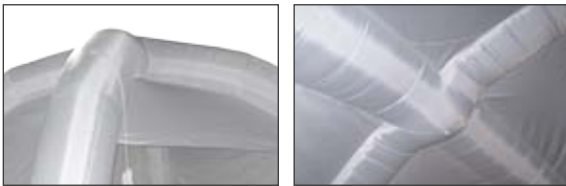

Inflatable Auditorium Tent; w/ electrical motor (pumps air continuously) located on the exterior. Use it for any publicity event. Includes fasten strings and pins. Fast and easy to set-up!

**Material:** Fabric.

15.169  4500x4500x2900mm



## Inflatable Screen



Inflatable screen; with electrical motor (pumps air continuously) located on the exterior. The middle screen piece is hold-up by Velcro this permits the exchange of the screen or the graphic. Use it for projectors, events, or exterior publicity. Includes fasten strings and pins. Fast and easy to set-up!

**Material:** Fabric.

15.162

15.163  5200x4000mm

15.164

15.165  3000x3000mm

## Inflatable Arch



Inflatable arch; with electrical motor (pumps air continuously) great for any sport event, can be set-up on any ground, fasten strings and pins included, fast and easy to set-up.

**Material:** Fabric.

15.166

15.167

15.168  6000x4000mm





4

## Beresford



Outdoor ashtray. Body: 1.0 stainless steel. Top/Bottom: Aluminium alloy. Opening-closing key and screws includes. Size: Ø 75x920mm. Base: Ø 370mm.

**Material:** Aluminium, stainless steel.

13.288

920mm

## Popkum



Outdoor ashtray. Opening-closing key and screws includes. Size: Ø 80x480mm.

**Material:** Aluminium, stainless steel.

13.284

## Paulson



Outdoor ashtray. Opening-closing key and screws includes. Size: 80x80x480mm.

**Material:** Aluminium, stainless steel.

13.285

## Sunbury



Outdoor ashtray. Opening-closing key and screws includes. Size: Ø 80x480mm.

**Material:** Aluminium, stainless steel.

13.286

## Femdale



Outdoor ashtray. Opening-closing key and screws includes. Size: 80x80x480mm.

**Material:** Aluminium, stainless steel.

13.287



## Urban Outdoor Bins

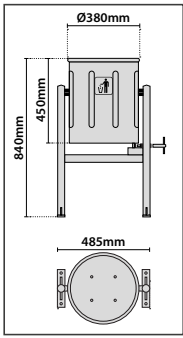

outside bin blind, manufactured in iron, fixing of ground support, discharge system swingarm, high resistance to the rust.

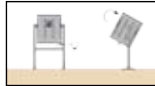

**Material:** Iron.

**34.028**

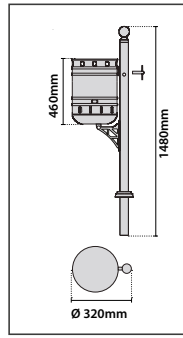

Outside bin, manufactured in iron, fixation to the ground by post, easy discharge.

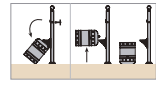

**Material:** Iron.

**34.029**

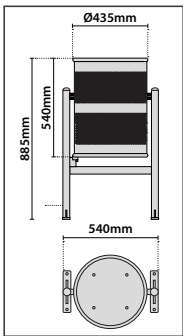

Outside bin, manufactured in iron, fixing of ground support, discharge system swingarm, high resistance to the rust.

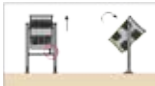

**Material:** Iron.

**34.030**

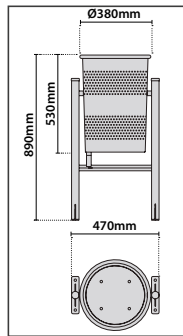

Outside bin, manufactured in stainless steel sheet, fixing of ground support, discharge system swingarm, high resistance to the rust.



**Material:** Iron.

**34.031**

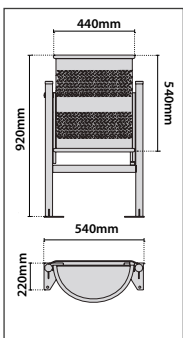

Outside bin semicircular, manufactured in iron, fixing of ground support, discharge system swingarm, high resistance to the rust.

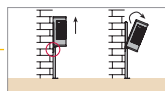

**Material:** Iron.

**34.032**

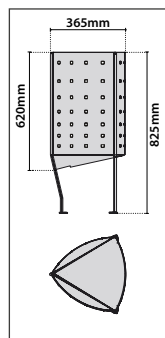

Outside bin triangular, manufactured in iron, fixing of ground support, high resistance to the rust.

**Material:** Iron.

**34.033**

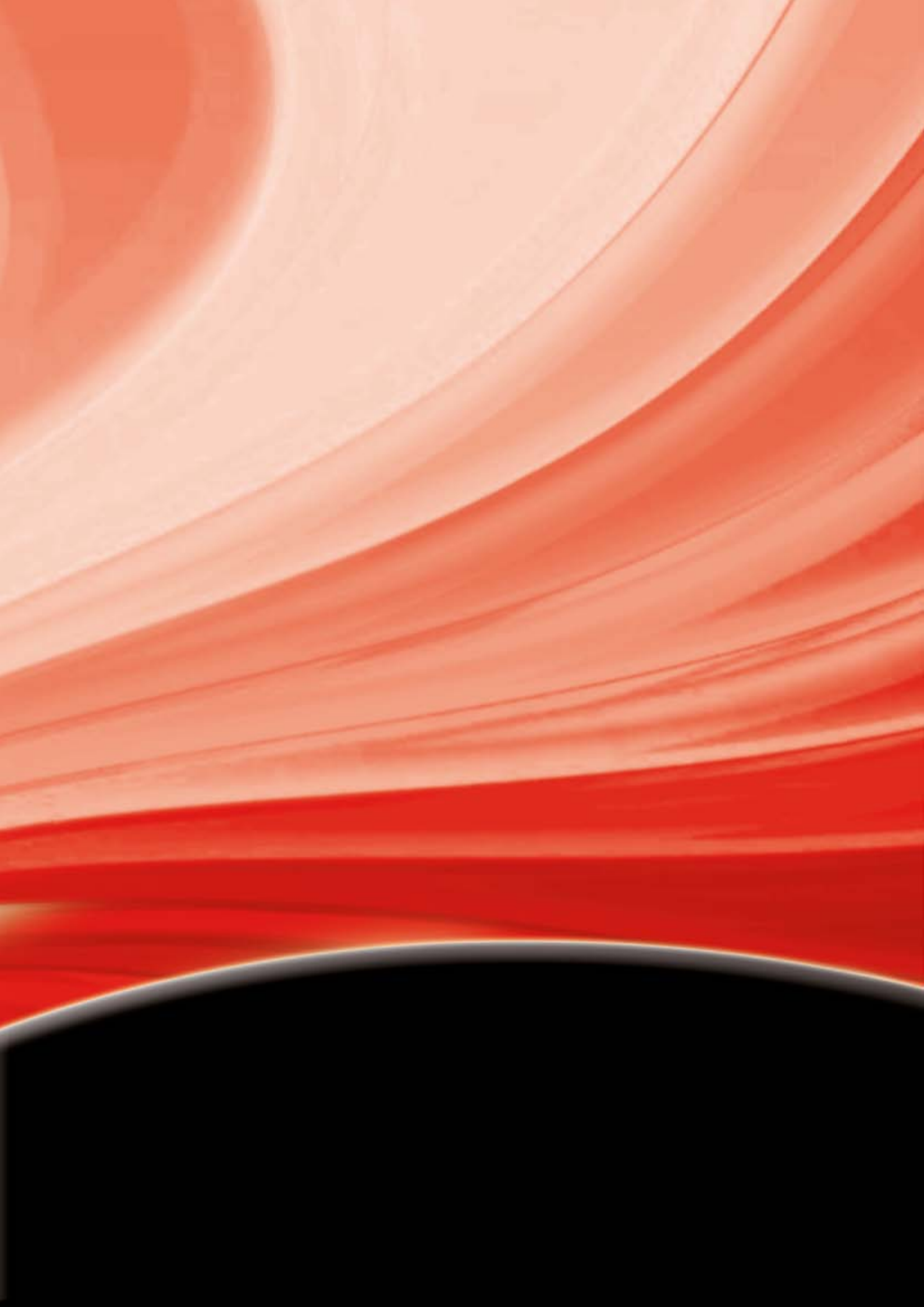





cable kit

## Alpha

Modern and practical cable and tension system which allows you to quickly and easily set up expositions, displays, etc. The system is made of tensioners and cables ceiling/ floor and different models of grips in sizes and formats and methacrylate poster holders for all types of documents.

### Cable System



For suspending from ceiling to floor. Consists of 3m steel cable, 1 ceiling fixing and 1 floor fixing.

**Material:** Steel.

12.118	Ceiling fixing	
12.119	Floor fixing	



### Ceiling Fixing



For aluminium track. Colour: chrome.

**Material:** Stainless steel.

12.120	Ø 40x170mm	Pack 10 Uni.	
--------	------------	--------------	--

### Clips

Panel clip for cable system.

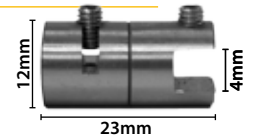

12.122	Pack 10 Uni.	
--------	--------------	--

For holding two vertical adjacent panels in the cable system.



12.123	Pack 10 Uni.	
--------	--------------	--

Wall fixing clip.

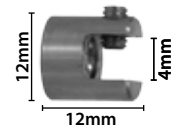

12.124	Pack 10 Uni.	
--------	--------------	--

### Wire Cable



Diameter: 1mm. Length of roll: 25m.

**Material:** Steel cable.

12.121	Ø 1mm x 25m	
--------	-------------	--

### Aluminium Load



Aluminium load for cable system.

500 grs.

**Material:** Aluminium.

12.117	Ø 40x170mm	
--------	------------	--

### Aluminium Track



Aluminium track for cable system. Length: 2m or 3m.

**Material:** Aluminium.

12.127	2000mm	
12.128	3000mm	

## Beta

Cable and tension system with flat shelves. Modern and practical cable and tension system wich allows you to quickly and easily set up expositions, display, franchises, etc. The system is made of tensioers, cables and differents simple and double grips. Finish in chrome.

### Cable Shelf Clip

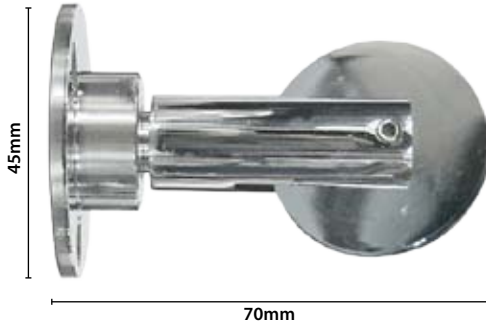

Cable shelf clip. For 3mm wire cable.

**Finish:** Chrome.

**12.306** Pack 4 Uni.



### Wire Cable



Ø 3mm.

Diameter: 3mm. Lenght of roll: 25m.

**Material:** Steel cable.

**12.311** Ø 3mm x 25m

### Horizontal Panel Clip

For cable system. Holds shelves up to 6mm thick.

**Finish:** Chrome.

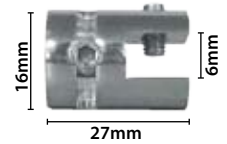

**12.309** Pack 10 Uni.

### Double Panel Clip

For holding two vertical adjacent panels in the cable system. For panels up to 6mm thick.

**Finish:** Chrome.

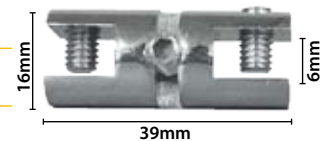

**12.310** Pack 10 Uni.

### Wall-Mounting Clip Double



With joint for double cable system.

**Finish:** Chrome.

**12.307** Pack 4 Uni.

### Rod Support



For 2 point fixing of shelves.

**Finish:** Chrome.

**12.308** Pack 4 Uni.

## Delta

Cable and tension system. Modern and practical cable and tension which allows you to quickly and easily set up acrylic pockets. The system is made of tensioners and cables ceiling/floor or wall/wall, an extensive range of grips. Finish in chrome.

### Wall-Mounting Clip for Ceiling/Wall

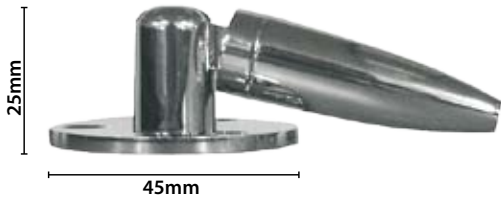

Wall-mounting for ceiling/wall. With joint for cable system. For cable of 1.5mm.

**Finish:** Chrome.

**12.316**      **Pack 4 Uni.**



### Wall-Mounting Clip for Ceiling/Floor

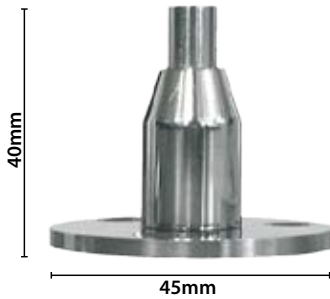

Wall-mounting for ceiling/floor. With joint for cable system. For cable of 1.5mm to 3mm.

**Finish:** Chrome.

**12.317**      **Pack 4 Uni.**

### Vertical Panel Clip

Holds vertical panels up to 6mm thick. For cable of 1.5mm to 3mm.

**Finish:** Chrome.

**12.318**      **Pack 10 Uni.**

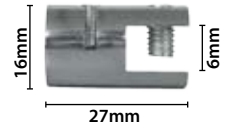

### Double Panel Clip

For holding two vertical adjacent panels in the cable system. For panels up to 6mm thick.

**Finish:** Chrome.

**12.319**      **Pack 10 Uni.**

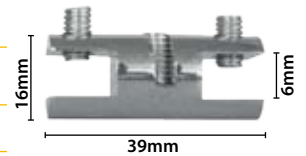

### Wire Cable

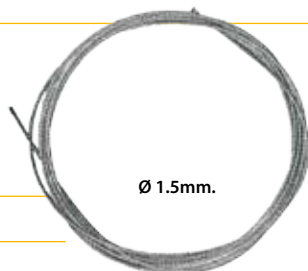

Diameter: 1.5mm. Length of roll: 25m.

**Material:** Steel cable.

**12.315**      **Ø 1.5mm x 25m**



Diameter: 3mm. Length of roll: 25m.

**Material:** Steel cable.

**12.311**      **Ø 3mm x 25m**

## Gamma

Cable and tension system. Modern and practical cable and tension system kit which allows you to quickly and easily set up exposition, displays, shops, etc. The system is made of grips, tensioners and cables ceiling/floor or ceiling/suspended, an extensive range of grips. Aluminium natural silver.

### Wall-Mounting Top Clip

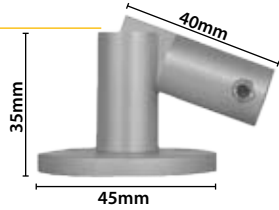

With joint for cable system. For cable wire up to 1.5-3mm thick. Colour: natural silver.

**Material:** Aluminium.

**12.312 Pack 4 Uni.**



### Wall-Mounting Bottom Clip

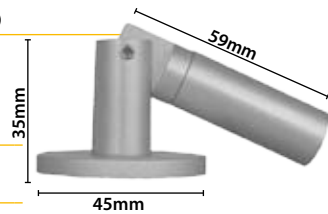

With joint for cable system. For cable wire up to 1.5-3mm thick. Colour: natural silver.

**Material:** Aluminium.

**12.313 Pack 4 Uni.**

### Vertical Panel Clip

For cable system. Holds up to 6mm thick panels. Colour: natural silver.

**Material:** Aluminium.

**12.314 Pack 10 Uni.**

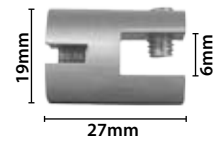

## Epsilon

Modern and practical cable and tension system which allows you to quickly and easily set up exhibitions, displays, etc. The system is made of tensioners and cables ceiling/floor or wall/wall, an extensive range of grips. Finish in chrome.

### Wall-Mounting Clip

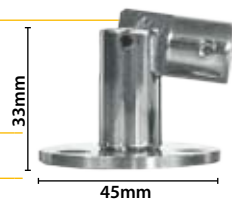

With joint for cable system.

**Finish:** Chrome.

**12.320 Pack 4 Uni.**

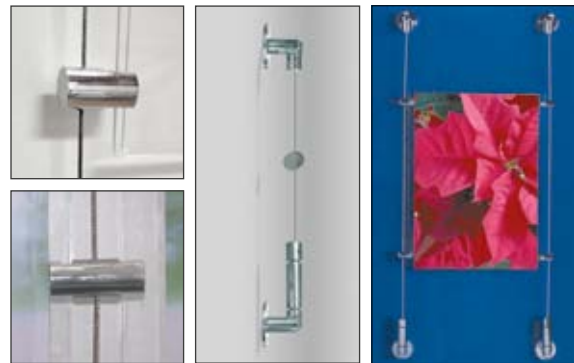

### Vertical Panel Clip

Holds vertical panels up to 6mm thick. For cable of 1.5mm to 3mm.

**Finish:** Chrome.

**12.318 Pack 10 Uni.**

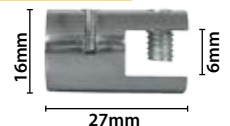

### Wall-Mounting Clip

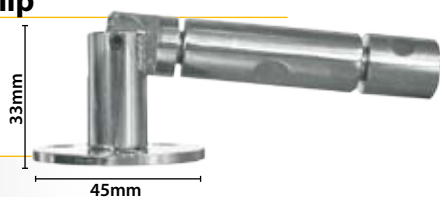

With joint for cable system.

**Finish:** Chrome.

**12.321 Pack 4 Uni.**

### Double Panel Clip

For holding two vertical adjacent panels up to 6mm thick in the cable system.

**Finish:** Chrome.

**12.319 Pack 10 Uni.**

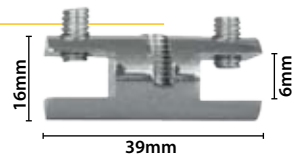

## Sigma

Modern and practical Rod Display System which allows you to quickly and easily set up expositions, displays, etc. For 5mm diameter steel bar. Colour: chrome.



### Steel Bar



Different lengths are available. Diameter: 5mm.

**Material:** Steel.

**12.343**       $\varnothing$  5x1000mm

**12.344**       $\varnothing$  5x1500mm

**12.345**       $\varnothing$  5x2000mm

### Middle Glass Support Base

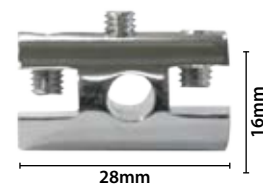

For glass thickness 5mm.

**Finish:** Chrome.

**12.342**      Pack 4 Uni.

### Wall Fixing



Wall fixing for 5mm rod.

**Finish:** Chrome.

**12.340**      Pack 4 Uni.

### Glass Support Base

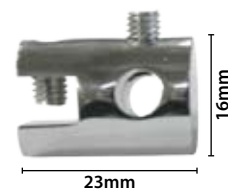

For glass thickness 5mm.

**Finish:** Chrome.

**12.341**      Pack 4 Uni.

## Free Standing

Cable system displayed in a mobile aluminium framework with levellers. The system is composed for aluminium framework, tensioners, single and double panel clips, 1.5mm steel cable. Acrylic pocket not included.

### Free Standing 900x2120mm



**Includes:**

- Framework: 1
- Top tensioner: 4
- Bottom tensioner: 4
- Single panel clip: 24
- Double panel clip: 24
- Cable 1.5mm: 8.8m

**Material:** Aluminium, plastic, steel cable.

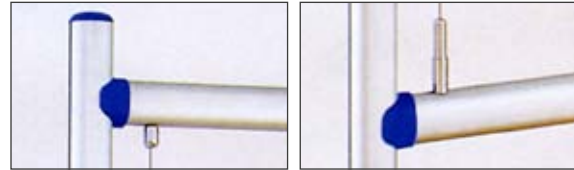

**12.354**      **900x2120mm**

### Free Standing 1200x2120mm



**Includes:**

- Framework: 1
- Top tensioner: 5
- Bottom tensioner: 5
- Single panel clip: 24
- Double panel clip: 36
- Cable 1.5mm: 10.6m

**Material:** Aluminium, plastic, steel cable.

**12.355**      **1200x2120mm**

### Free Standing 1500x2120mm

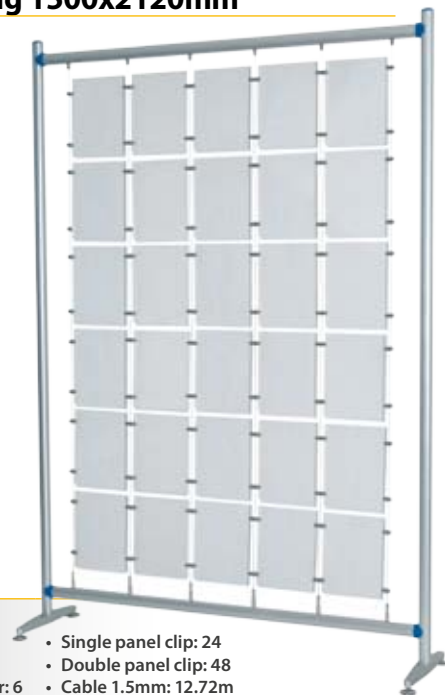

**Includes:**

- Framework: 1
- Top tensioner: 6
- Bottom tensioner: 6
- Single panel clip: 24
- Double panel clip: 48
- Cable 1.5mm: 12.72m

**Material:** Aluminium, plastic, steel cable.

**12.356**      **1500x2120mm**

## Acrylic Pocket

Acrylic pocket for cable system. Sizes A4 or A3.

**Material:** Acrylic.



12.125	A4 Horizontal	
12.351	A3 Horizontal	
12.126	A4 Vertical	
12.352	A3 Vertical	

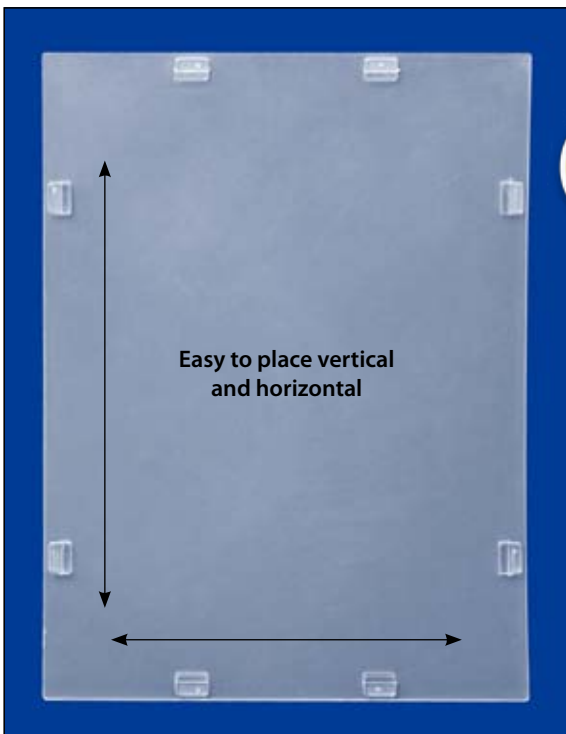

12.420	A4	
--------	----	--





6

white boards and screens

## Enamelled Whiteboard

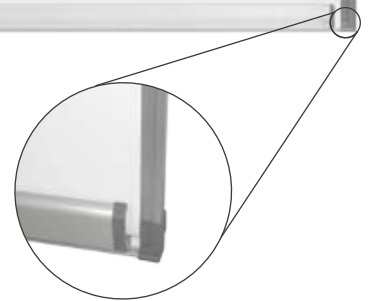
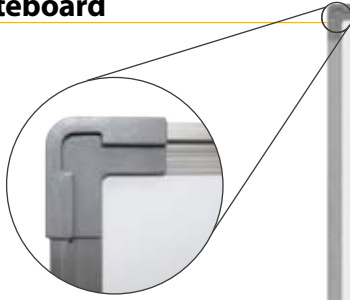

Whiteboard equipped with silver anodised aluminium frame and grey plastic rounded corners. Magnet attachable. Enamelled background suitable for writing with dry wipe board markers. Easy to clean. Thickness: 18mm. Five different sizes.

**Material:** Aluminium, plastic, metal.

14.000	900x600mm	<input type="checkbox"/>
14.001	1200x900mm	<input type="checkbox"/>
14.002	1500x1200mm	<input type="checkbox"/>
14.003	1800x1200mm	<input type="checkbox"/>
14.004	2000x1200mm	<input type="checkbox"/>

## Cork Board



Cork board equipped with silver anodised aluminium frame and grey plastic rounded corners. Ideal for pinning up notes, notices, posters, etc. Cork thickness: 8mm.

**Material:** Aluminium, plastic, cork.

14.008	600x450mm	<input type="checkbox"/>
14.009	900x600mm	<input type="checkbox"/>
14.010	1200x900mm	<input type="checkbox"/>
14.011	1500x900mm	<input type="checkbox"/>
14.012	1500x1200mm	<input type="checkbox"/>
14.013	1800x1200mm	<input type="checkbox"/>

## Felt Board



Felt notice board with cork background, equipped with silver anodised aluminium frame and grey plastic rounded corners. Ideal for pinning up notes, notices, posters, etc. Covered with fabric in 3 different colours.

**Material:** Aluminium, plastic, cork, felt.

14.016

14.017

14.018

900x600mm



## Dax

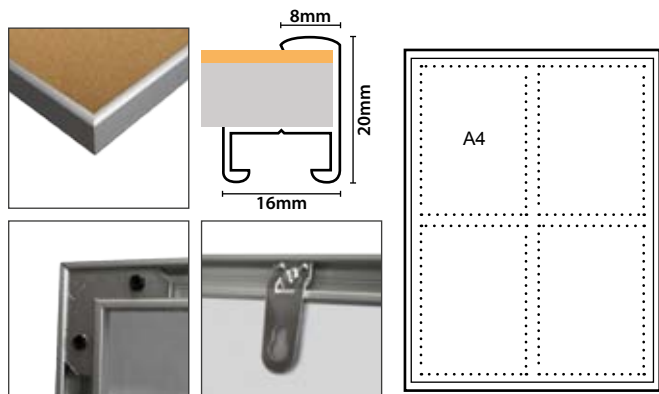

Notice board. Anodised aluminium frame, cork background. Allows the placing of notes with drawing pins. Great for the office, communities, public buildings, etc. Interior use.

**Material:** Aluminium, cork.

10.320	4xA4	
10.321	6xA4	
10.325	9xA4	
10.328	12xA4	

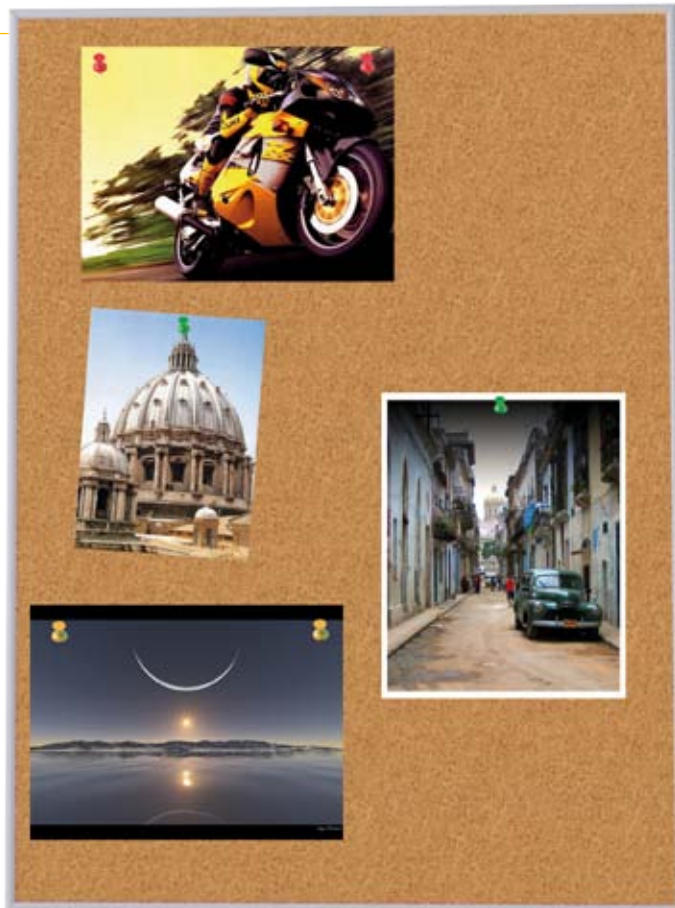

## Rennes

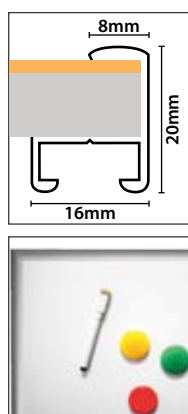

Notice board, anodised aluminium frame, magnetic background, write notes with a marker pen or place notes up with magnetic pins. Easy to clean!

**Material:** Aluminium, metal.

10.329	4xA4	
10.330	6xA4	
10.331	9xA4	
10.332	12xA4	

## Salles

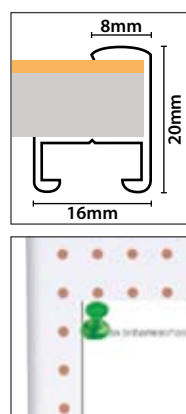

Notice board, anodised aluminium frame, cork and magnetic background. Ideal for placing notes, documents, messages, etc. Notes hold-up by drawing pins or magnetic pins.

**Material:** Aluminium, plastic, cork, metal.

10.333	4xA4	
10.334	6xA4	
10.335	9xA4	
10.336	12xA4	

## Dual Corkboard



Dual corkboard + dry-wipe whiteboard. Ideal for pinning up notes, notices, posters, etc. Suitable for writing with dry wipe board markers.

**Material:** Plastic, wood, cork.

14.014	600x900mm	
14.015	900x1200mm	

## Magnet Blackboard

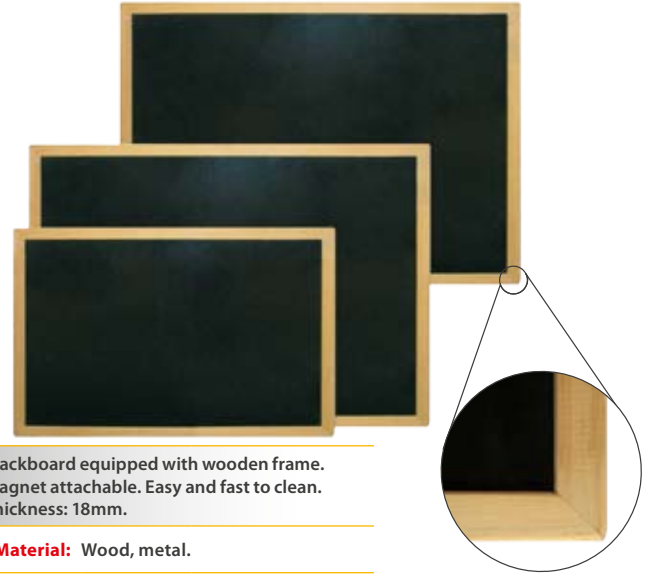

Blackboard equipped with wooden frame. Magnet attachable. Easy and fast to clean. Thickness: 18mm.

**Material:** Wood, metal.

14.005	450x300mm	
14.006	600x450mm	
14.007	900x600mm	

## Chalkboard Barock



Wall mount chalkboard. Available horizontal or vertical. Mahogany colour.

**Material:** Wood.

14.054	555x955mm		
14.055	980x580mm		

## Chalkboard



Wall mount chalkboard. Available in four different sizes. Mahogany colour.

**Material:** Wood.

14.050	560x1000mm	
14.051	560x1200mm	
14.052	560x1500mm	
14.053	560x1700mm	

## Chalkboard



Chalkboard equipped with natural wood frame.

**Material:** Wood.

10.350	A4	
10.351	A3	
10.352	A2	

## Tripod Board



Tripod structure for placing chalkboards or frames. Mahogany colour.

**Material:** Wood.

14.056	Height: 1650mm	
--------	----------------	--

## Marker Board



Marker board equipped with natural wood frame.

**Material:** Wood.

10.170	500x700mm	
10.171	700x1000mm	

## Chalkboard without Legs

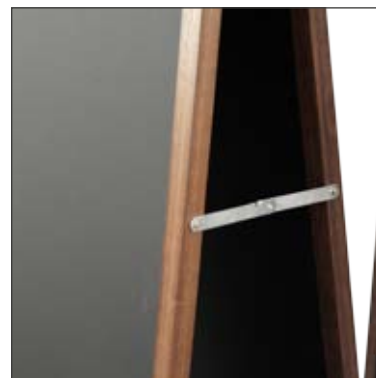

Double face chalkboard without legs. Available in two different sizes. Mahogany colour.

**Material:** Wood.

14.048	560x1200mm	
14.049	560x1700mm	

## Chalkboard with Legs



Double face chalkboard with legs. Mahogany colour.

**Material:** Wood.

14.047	540x850mm		
--------	-----------	--	--

14.049	560x1700mm		
--------	------------	--	--

## Flipchart



Flipchart equipped with adjustable height tripod. Surface is suitable for writing with dry wipe board markers. Colour black. Magnet attachable.

**Material:** Steel, plastic.

**14.019**      **700x1030mm**



## Revolving Whiteboard



Revolving whiteboard equipped with silver anodised aluminium frame and grey plastic rounded corners. Double sided surface is suitable for writing with dry wipe board markers. Metallic moveable support equipped with 4 castors.

**Material:** Aluminium, plastic, metal.

**14.020**      **600x900mm**

**14.021**      **1500x1200mm**

**14.022**      **1800x1200mm**

Revolving



## Whiteboard Accesories

### Magnets



14.031

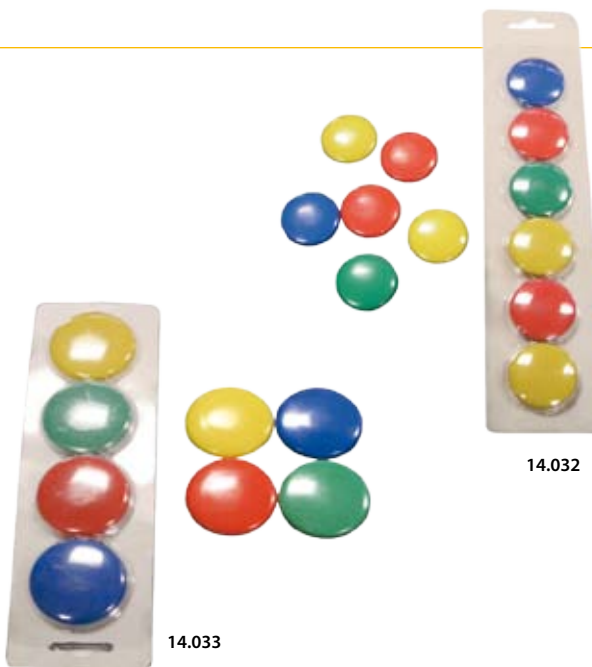

14.032

14.033

Magnets for boards. Different sizes an colours.

**Material:** Plastic.

14.031	Ø 20mm	Pack 12 Uni.	<input type="text"/>
14.032	Ø 30mm	Pack 6 Uni.	<input type="text"/>
14.033	Ø 40mm	Pack 4 Uni.	<input type="text"/>

### Pins

PBox of 100 pins. Colours assortment.

**Material:** Plastic, steel.

14.034	<input type="text"/>
--------	----------------------



### Eraser



Plastic eraser for boards.

**Material:** Plastic.

14.030	<input type="text"/>
--------	----------------------

## Wall Projector Screen



Wall or ceiling projector screen. The fabric can be unrolled to the wished measurement.

**Material:** Steel, plastic parts.

14.035	1520x1520mm	
14.036	1780x1780mm	

## Electrical Projector Screen



Wall or ceiling projector screen. Roll up mechanism driven through an electrical motor.

**Material:** Steel, plastic parts.

14.037	1450x1450mm	
14.038	1700x1700mm	



## Tripod Projector Screen



Tripod projector screen. Stability of the screen is ensured by a locking tripod stand. Easy to install and to use. Black tripod and white screen.

**Material:** Steel, plastic parts.

14.039	1520x1520mm	
14.040	1780x1780mm	

## Roll Up Projector Screen



Roll up projector screen. Easy to install and to use. Colour black.

**Material:** Aluminium, plastic parts.

14.041	1500x2050mm	White screen: 1460x1460mm	
14.042	1770x2050mm	White screen: 1710x1710mm	



## Showcases

Enclosed notice showcase, wall mount or floor base. Magnet, cork or metal and cork background. Lateral lock. Aluminium frame and 3mm thickness glass. Waterproof. Ideal for placing notes messages, documents, etc. with pins or magnets.

**Material:** Aluminium, tempered glass.



### Metz

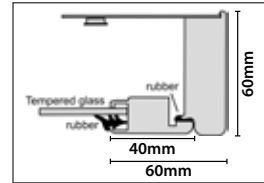

Thickness aluminium 1.5mm to 1.8mm

**Background:** Magnet Metal.

14.058	1000x840mm	
14.059	750x1090mm	
14.060	750x660mm	
14.061	1150x940mm	
14.062	1350x1090mm	
14.064	850x1240mm	



### Bremen

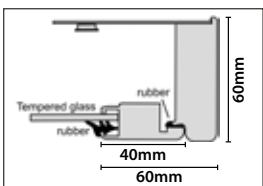
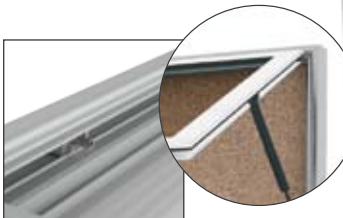

Thickness aluminium 1.5mm to 1.8mm

**Background:** Cork.

14.067	1000x840mm	
14.068	750x1090mm	
14.069	750x660mm	
14.070	1150x940mm	
14.071	1350x1090mm	
14.073	850x1240mm	



### Hannover

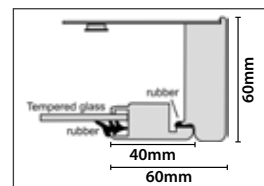
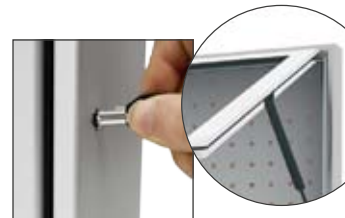

Thickness aluminium 1.5mm to 1.8mm

**Background:** Metal and cork.

14.076	1000x840mm	
14.077	750x1090mm	
14.078	750x660mm	
14.079	1150x940mm	
14.080	1350x1090mm	
14.082	850x1240mm	



## Showcase with Swing Door

Swing door showcase with cork background or magnetic white metal sheet. Made of silver anodised aluminium. Lockable. Ideal for pinning up notes or magnet.

**Material:** Aluminium, acrylic.



**Background:** Metal.

14.092	250x400mm	
14.045	350x500mm	
14.046	500x700mm	
14.093	600x600mm	



**Background:** Cork.

14.090	250x400mm	
14.043	350x500mm	
14.044	500x700mm	
14.091	600x600mm	

## Showcase with Swing Door in Cork



Showcase with cork background equipped with silver anodised aluminium frame and swing door. Lockable. Ideal for pinning up notes, notices, posters, etc. Thickness: 30mm.

**Material:** Aluminium, acrylic, cork.

14.026	600x600mm	
14.027	670x800mm	
14.028	670x1000mm	
14.029	800x1000mm	

## Showcase with Swing Door Magnetic

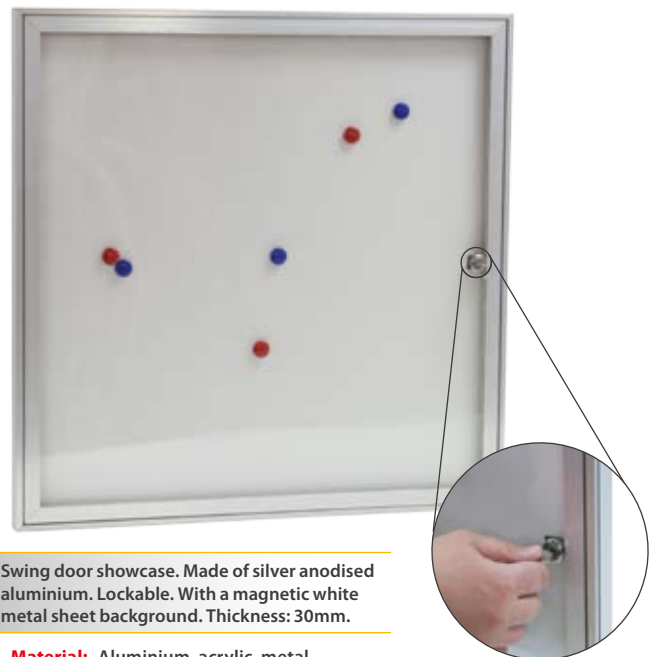

Swing door showcase. Made of silver anodised aluminium. Lockable. With a magnetic white metal sheet background. Thickness: 30mm.

**Material:** Aluminium, acrylic, metal.

14.023	600x600mm	
14.024	670x1000mm	
14.025	800x1000mm	

## Rostock

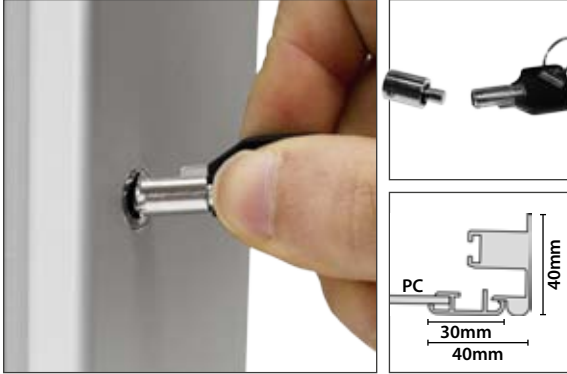

Enclosed notice showcase, wall mount, cork background. Lateral lock. Aluminium frame and PC door. Ideal for placing notes, messages, documents, etc. with pins.

**Material:** Aluminium, PC, cork.

14.084	500x700mm	<input type="text"/>
14.085	600x800mm	<input type="text"/>
14.086	700x1000mm	<input type="text"/>



## Wissmar

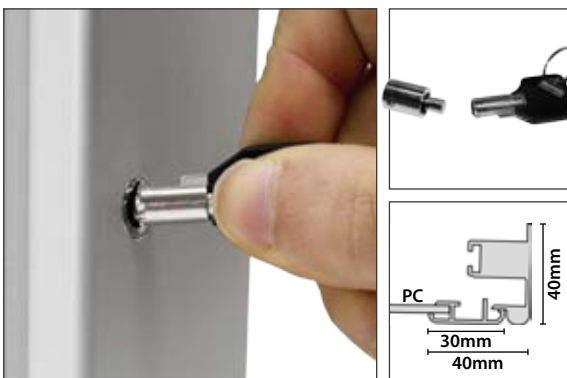

Enclosed notice showcase, wall mount, magnet background. Lateral lock. Aluminium frame and PC door. Ideal for placing notes, messages, documents, etc. with magnets.

**Material:** Aluminium, PC, metal.

14.087	500x700mm	<input type="text"/>
14.088	600x800mm	<input type="text"/>
14.089	700x1000mm	<input type="text"/>





7



leaflet dispensers

# MENU CARD HOLDER

## 7 Menu Card Holder "T" Open

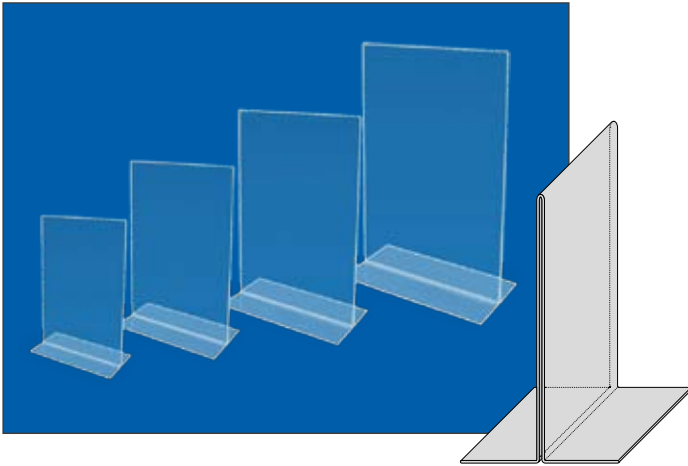

Menu card holder "T" open. Material: 2mm acrylic for A4, A5 and A6; 3mm acrylic for A3.

**Material:** Acrylic.

13.069	A3	Pack 10 Uni.	<input type="text"/>
13.027	A4	Pack 10 Uni.	<input type="text"/>
13.028	A5	Pack 10 Uni.	<input type="text"/>
13.068	A6	Pack 10 Uni.	<input type="text"/>

## Menu Card Holder "T" Closed

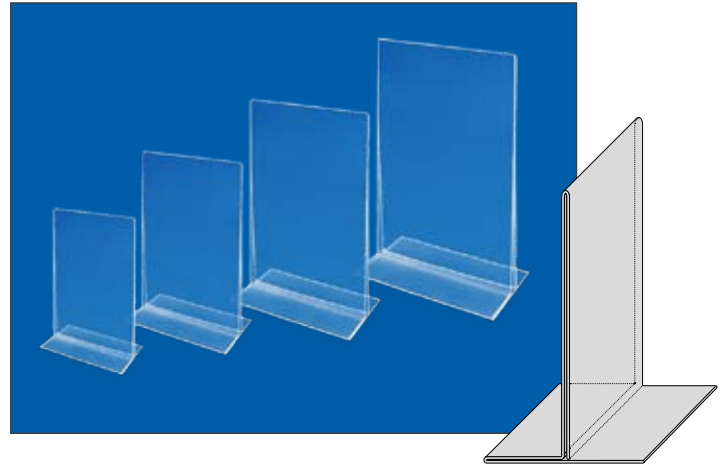

Menu card holder "T" closed. Material: 2mm acrylic for A4, A5 and A6; 3mm acrylic for A3.

**Material:** Acrylic.

13.000	A3	Pack 10 Uni.	<input type="text"/>
13.001	A4	Pack 10 Uni.	<input type="text"/>
13.002	A5	Pack 10 Uni.	<input type="text"/>
13.003	A6	Pack 10 Uni.	<input type="text"/>

## Acrylic "L" Display

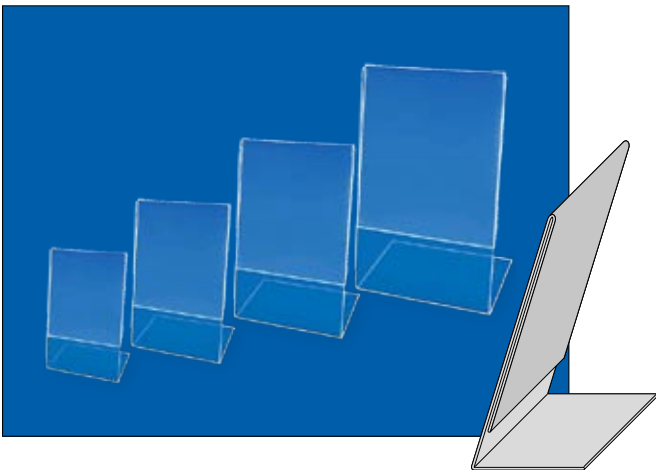

Acrylic "L" display. Material: 2mm acrylic for A4, A5 and A6; 3mm acrylic for A3.

**Material:** Acrylic.

13.004	A3	Pack 10 Uni.	<input type="text"/>
13.005	A4	Pack 10 Uni.	<input type="text"/>
13.006	A5	Pack 10 Uni.	<input type="text"/>
13.007	A6	Pack 10 Uni.	<input type="text"/>

## Menu Card Holder "Z"

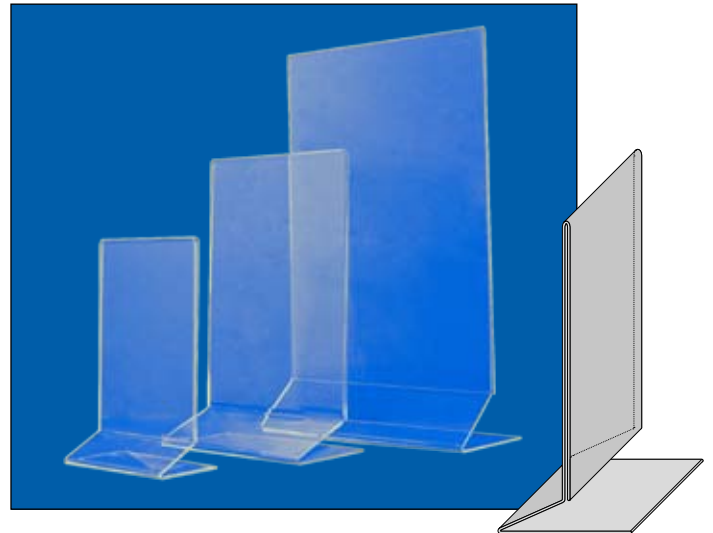

Menu card holder "Z". Material: 2mm acrylic. Colour: transparent. Sizes: A4, A5 and A6.

**Material:** Acrylic.

13.008	A4	Pack 10 Uni.	<input type="text"/>
13.009	A5	Pack 10 Uni.	<input type="text"/>
13.010	A6	Pack 10 Uni.	<input type="text"/>

## Menu Card Holder "Rectangular Wood"

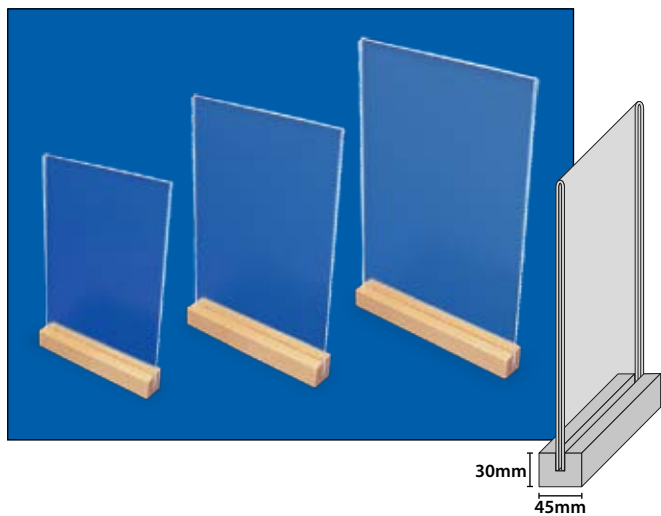

Menu card holder "rectangular wood". Natural wood base. 2mm acrylic insert pocket. Colour: transparent. Sizes: A4, A5 and A6.

**Material:** Wood & Acrylic.

13.011	A4	Pack 10 Uni.	<input type="text"/>
13.012	A5	Pack 10 Uni.	<input type="text"/>
13.013	A6	Pack 10 Uni.	<input type="text"/>

## Acrylic Y-Shaped Display

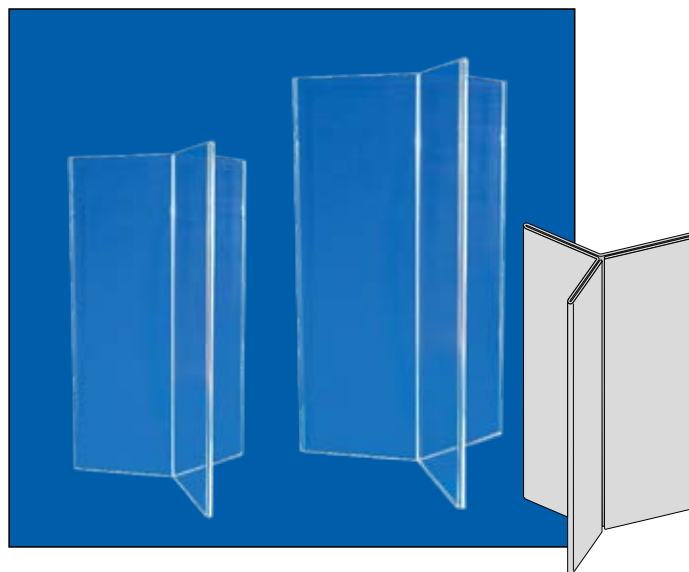

Acrylic Y-Shaped display. Material: 2mm acrylic. Colour: transparent. Sizes: A4 and A5.

**Material:** Acrylic.

13.014	A4	Pack 10 Uni.	<input type="text"/>
13.015	A5	Pack 10 Uni.	<input type="text"/>

## L-Display "Poster Snap"



L-Display "poster snap". Material: 2mm acrylic and aluminium "clip". Magnetic base. Colour: transparent. Sizes: A4 and A5.

**Material:** Acrylic.

13.016	A4	Pack 10 Uni.	<input type="text"/>
13.017	A5	Pack 10 Uni.	<input type="text"/>

## Menu Card Holder with Independent Base



Menu card holder with independent base. Material: 2mm acrylic. Colour: transparent pocket, clear base. Sizes: A4, A5.

**Material:** Acrylic.

13.018	A4	Pack 10 Uni.	<input type="text"/>
13.019	A5	Pack 10 Uni.	<input type="text"/>

# MENU CARD HOLDER

7

## Acrylic Pocket "Sandwich"

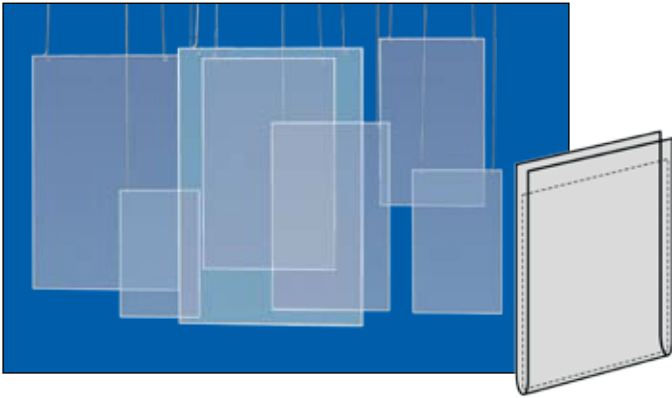

Acrylic pocket "sandwich". Material: 2mm acrylic. Colour: transparent. Sizes: A1, A2, A3, A4, A5, A6 and 500x700mm.

**Material:** Acrylic.

13.020	A1	Pack 10 Uni.	<input type="text"/>
13.021	A2	Pack 10 Uni.	<input type="text"/>
13.022	A3	Pack 10 Uni.	<input type="text"/>
13.023	A4	Pack 10 Uni.	<input type="text"/>
13.024	A5	Pack 10 Uni.	<input type="text"/>
13.025	A6	Pack 10 Uni.	<input type="text"/>
13.026	500x700mm	Pack 10 Uni.	<input type="text"/>

## Acrylic Tent Display

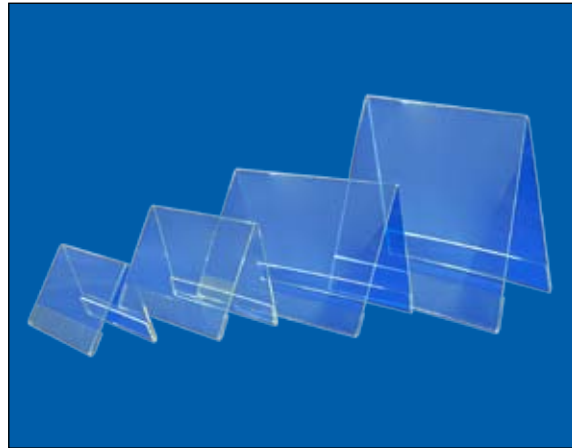

Acrylic tent display. With 2 inserts. Material: 2mm acrylic. Colour: transparent. Sizes: A4, A5, A6, A7 and 297x105mm.

**Material:** Acrylic.

13.029	A4	Pack 10 Uni.	<input type="text"/>	
13.030	A5	Pack 10 Uni.	<input type="text"/>	
13.031	A6	Pack 10 Uni.	<input type="text"/>	
13.032	A7	Pack 10 Uni.	<input type="text"/>	
13.033	297x105mm	Pack 10 Uni.	<input type="text"/>	

## Menu Card Holder "Luxe"



Menu card holder "Luxe". Colour: transparent.

**Material:** Polystyrol.

13.034	A5	Pack 10 Uni.	<input type="text"/>
--------	----	--------------	----------------------

## Menu Card Holder "M"

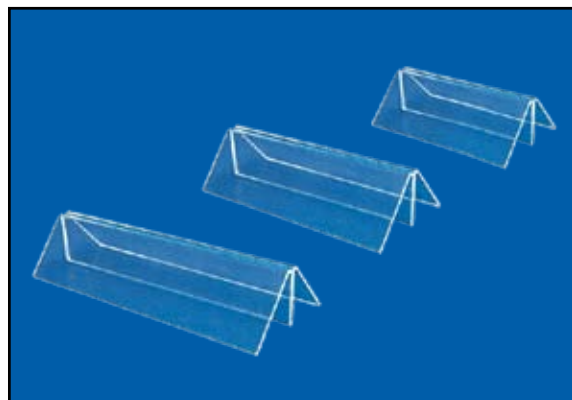

Menu card holder "M". Material: 2mm acrylic. Colour: transparent. Sizes: A4, A5 and A6.

**Material:** Acrylic.

13.035	210mm	Pack 10 Uni.	<input type="text"/>
13.036	148mm	Pack 10 Uni.	<input type="text"/>
13.037	105mm	Pack 10 Uni.	<input type="text"/>



## L-Display with Ring Binder



For A4 portrait sheets with 4 perforations. Material: 3mm acrylic. Colour: transparent. Size: A4+A4.

**Material:** Polystyrol.

**13.043**    **A4+A4**    **Pack 5 Uni.**

## Cash Caddie



With 4 rubber feet to prevent slipping. Colour: clear. Size: 210x175mm.

**Material:** Plastic.

**10.761**    **161x160mm**

## Revolving Display



Revolving display base.

**Material:** Plastic.

**13.072**    **Ø 140mm**

## Menubook

Wire docuholders. Chromed metal literature holders. Rubber feet protect countertop surfaces. Includes 10 plastic envelopes size A4.

**Material:** Steel, rubber, plastic.



13.122

	QTY	N.W(kg)	G.W(kg)	C.B.M.	Size(mm)
Uni.	1	1.9	2.15	0.012	360x340x100

**13.122**    **A4 "Black"**



13.123

	QTY	N.W(kg)	G.W(kg)	C.B.M.	Size(mm)
Uni.	1	5.2	5.4	0.018	345x345x155

**13.123**    **A4 "Black"**

## 7 Single Wall-Mounted Dispenser

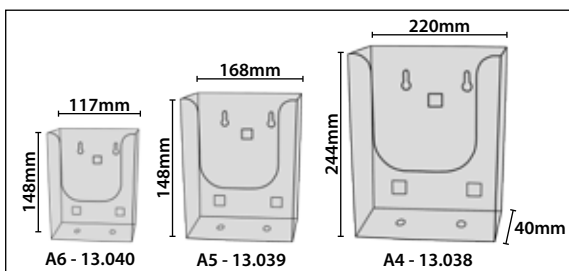

Single wall-mounted or desk dispenser. Colour: Transparent. Sizes: A4, A5 and A6.

**Material:** Polystyrol.

13.038	A4	Pack 10 Uni.	
13.039	A5	Pack 10 Uni.	
13.040	A6	Pack 10 Uni.	

## Single Wall-Mounted or Desk Dispenser

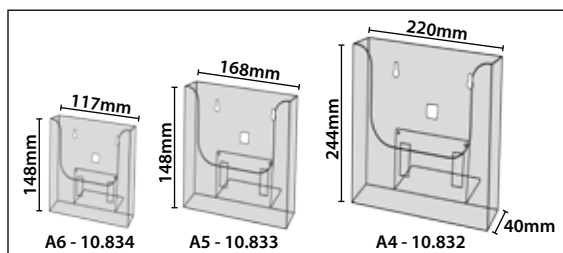

With 2 screw holes for wall-mounting and attachment for standing. Colour: Transparent. Sizes: A4, A5 and A6.

**Material:** Polystyrol.

10.832	A4	Pack 10 Uni.	
10.833	A5	Pack 10 Uni.	
10.834	A6	Pack 10 Uni.	

## Leaflet Dispenser

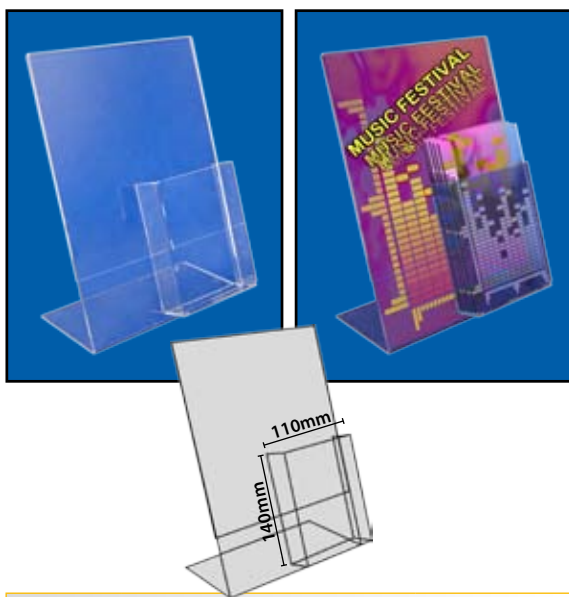

L-display with 1/3 A4 leaflet dispenser adhered to right. Colour: transparent. Material: 3mm acrylic for A3 and 2mm acrylic for A4.

**Material:** Acrylic.

13.041	A3	Pack 5 Uni.	
13.042	A4	Pack 5 Uni.	

## Wall-Mounted Dispenser with Suction

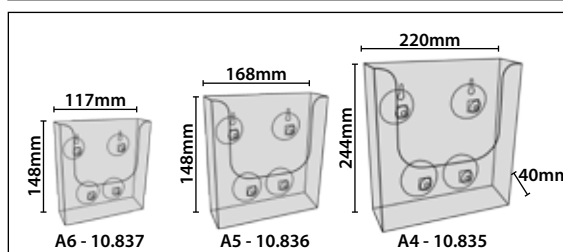

Single wall-mounted dispenser with suction cup. Colour: transparent. Sizes: A4, A5 and A6.

**Material:** Polystyrol.

10.835	A4	Pack 10 Uni.	
10.836	A5	Pack 10 Uni.	
10.837	A6	Pack 10 Uni.	

## Literature Holder

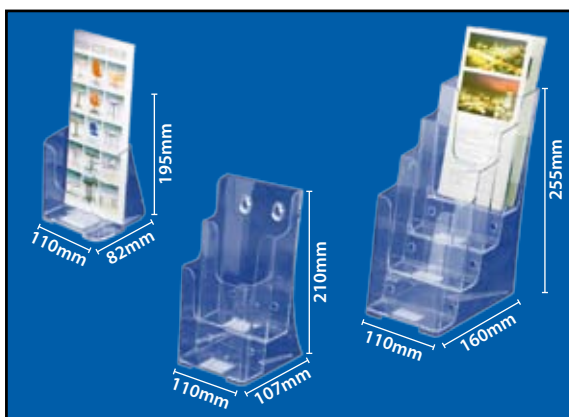

Literature holder for countertop or wallmount use. Size 1/3 A4.

**Material:** Polystyrol.

13.103	1x1/3 A4	Pack 6 Uni.	<input type="checkbox"/>	
13.104	2x1/3 A4	Pack 6 Uni.	<input type="checkbox"/>	
13.105	4x1/3 A4	Pack 4 Uni.	<input type="checkbox"/>	

## Literature holder

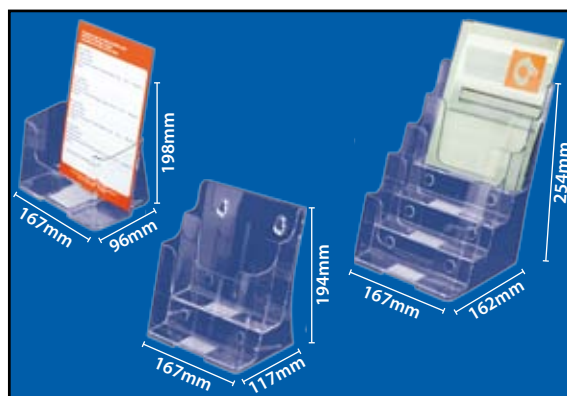

Literature holder for countertop or wallmount use. Size A5.

**Material:** Polystyrol.

13.106	1xA5	Pack 8 Uni.	<input type="checkbox"/>	
13.107	2xA5	Pack 5 Uni.	<input type="checkbox"/>	
13.108	4xA5	Pack 4 Uni.	<input type="checkbox"/>	

## Literature Holder

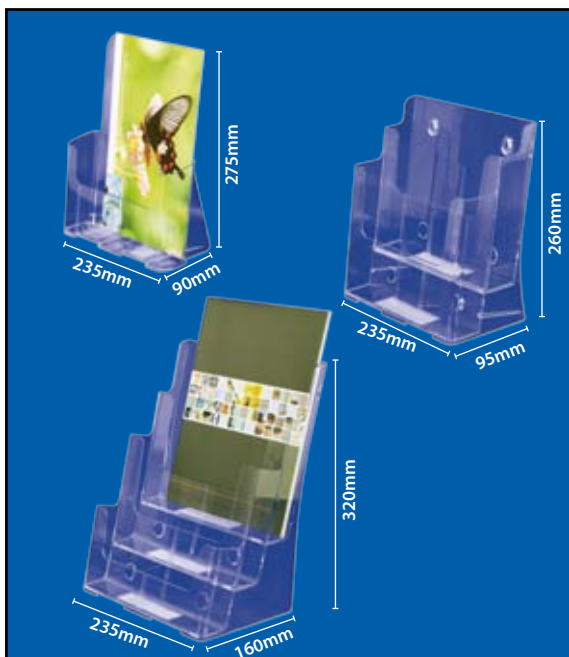

Literature holder for countertop or wallmount use. Size A4.

**Material:** Polystyrol.

13.109	1xA4	Pack 7 Uni.	<input type="checkbox"/>	
13.110	2xA4	Pack 4 Uni.	<input type="checkbox"/>	
13.111	3xA4	Pack 2 Uni.	<input type="checkbox"/>	

## Literature Holder for Countertop

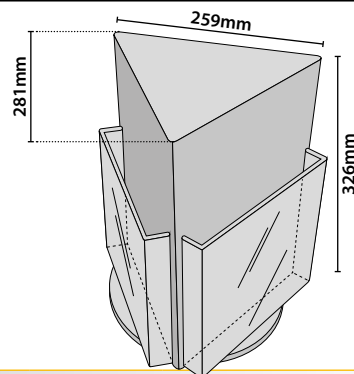

Rotating literature holders. Three-sided units have clear pockets for easy viewing. Colours: Black or white. Size A4.

**Material:** Polystyrol.

13.115	<input type="checkbox"/>	A4 - White	<input type="checkbox"/>
13.116	<input checked="" type="checkbox"/>	A4 - Black	<input type="checkbox"/>

## Outdoor Literature Box

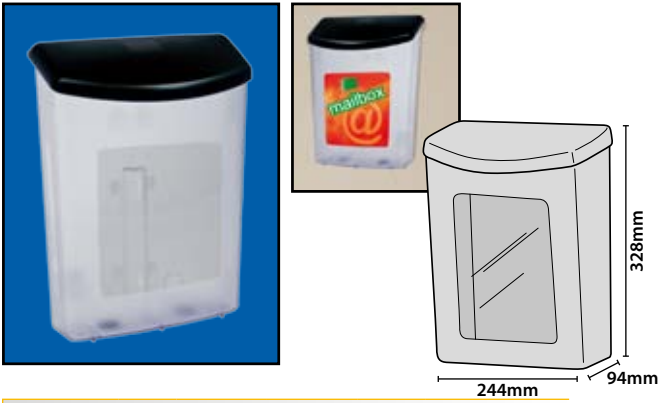

Break-resistant and weatherproof. Fits a variety of poles and post. Clear box with black lid.

**Material:** Polystyrol.

	QTY	N.W(kg)	G.W(kg)	C.B.M.	Size(mm)
Uni.	1	0.6	0.8	0.013	270x350x140

13.125

## Wall-Mounted Leaflet Dispenser

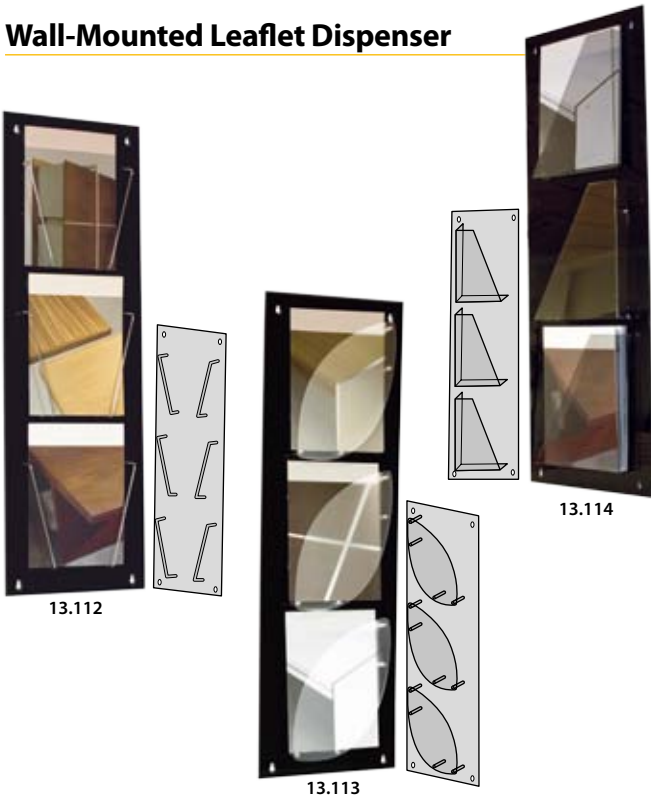

Wall mount literature display. Pockets are preassembled to a black back panel. Size A4.

**Material:** Polystyrol.

13.112	A4 "Line"	320x1009mm	
13.113	A4 "Oval"	320x1009mm	
13.114	A4 "Flash"	320x1009mm	

## Wall Pocket Landscape or Portrait

Wall pocket landscape or portrait. Size A4.

**Material:** Polystyrol.

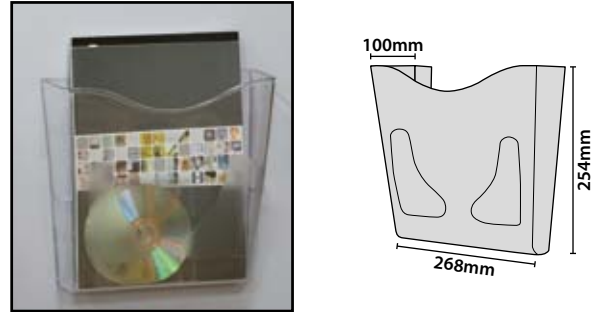

	QTY	N.W(kg)	G.W(kg)	C.B.M.	Size(mm)
Uni.	1	0.32	0.52	0.008	270x270x115

13.126

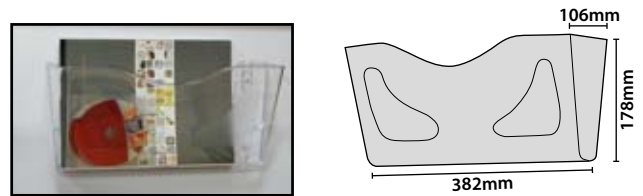

	QTY	N.W(kg)	G.W(kg)	C.B.M.	Size(mm)
Uni.	1	0.3	0.5	0.009	405x200x115

13.127

## Wall-Mounted Leaflet Dispenser



Wall-mounted leaflet dispenser. For 3x A4 leaflets. For 4x A5 leaflets.

**Material:** Polystyrol.

13.044	3x A4	
13.045	4x A5	

## Acrylic Easel

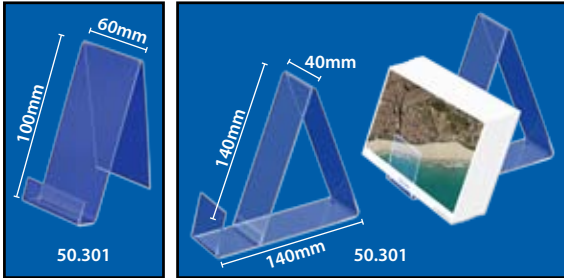
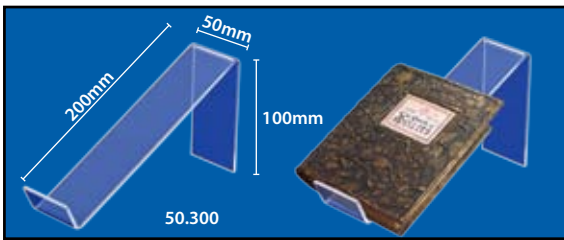

Acrylic easel. 2mm.

**Material:** Acrylic.

50.300	200x50mm	Pack 5 Uni.	<input type="text"/>
50.301	100x60mm	Pack 5 Uni.	<input type="text"/>
50.302	140x40mm	Pack 5 Uni.	<input type="text"/>

## Acrylic Business Card Holders

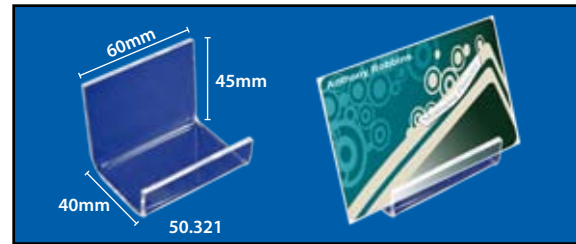
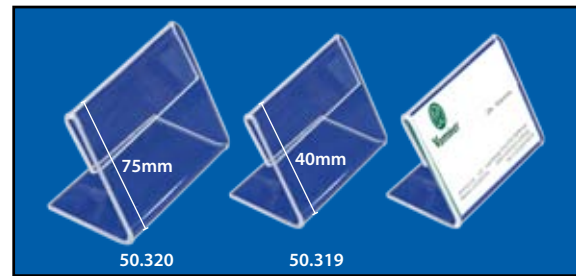

Acrylic business card holders. 2mm.

**Material:** Acrylic.

50.319	50x40mm	Pack 10 Uni.	<input type="text"/>
50.320	105x75mm	Pack 10 Uni.	<input type="text"/>
50.321	60x45x40mm	Pack 10 Uni.	<input type="text"/>

## Acrylic Narrow 2 Steps Stand

Acrylic narrow 2 steps stand. 3mm.

**Material:** Acrylic.

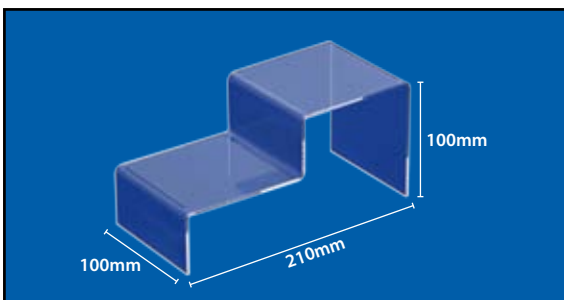

50.306	100x100x210mm	Pack 5 Uni.	<input type="text"/>
--------	---------------	-------------	----------------------

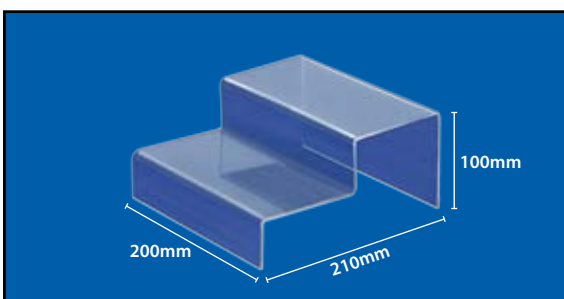

50.307	200x100x210mm	Pack 5 Uni.	<input type="text"/>
--------	---------------	-------------	----------------------

## Acrylic Narrow 3 Steps Stand

Acrylic narrow 3 steps stand. 3mm.

**Material:** Acrylic.

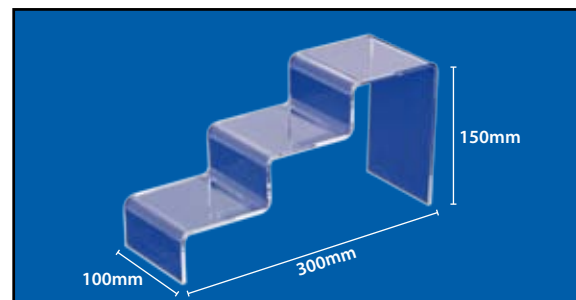

50.304	100x150x300mm	Pack 5 Uni.	<input type="text"/>
--------	---------------	-------------	----------------------

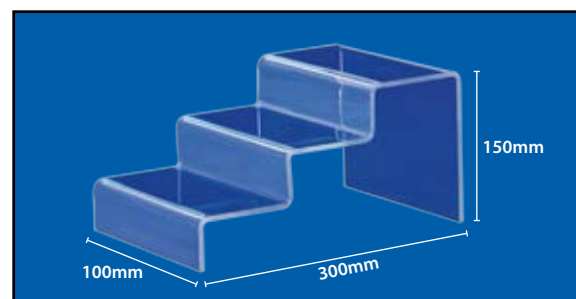

50.305	200x150x300mm	Pack 5 Uni.	<input type="text"/>
--------	---------------	-------------	----------------------

## Acrylic Narrow Podium

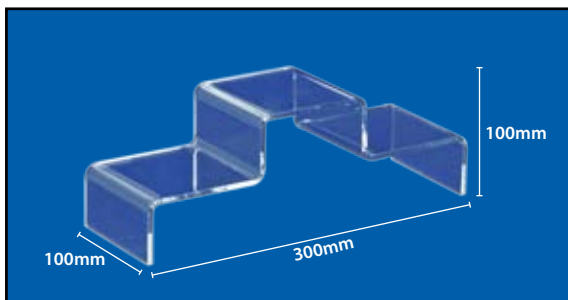

Acrylic narrow podium. 3mm.

**Material:** Acrylic.

**50.303** 100x100x300mm Pack 5 Uni.

## Acrylic U-Shaped Stand

Set of 3 or 4 U-shaped acrylic stand. 3mm

**Material:** Acrylic.

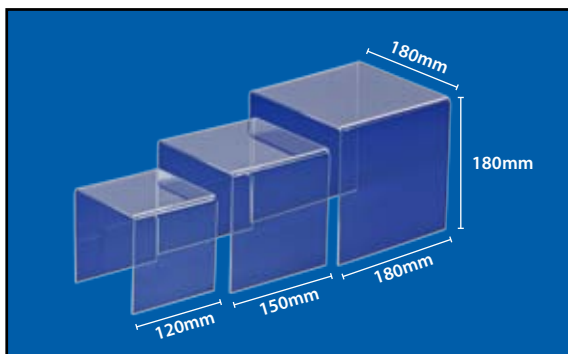

**50.309** 180x180x180mm Set of 3

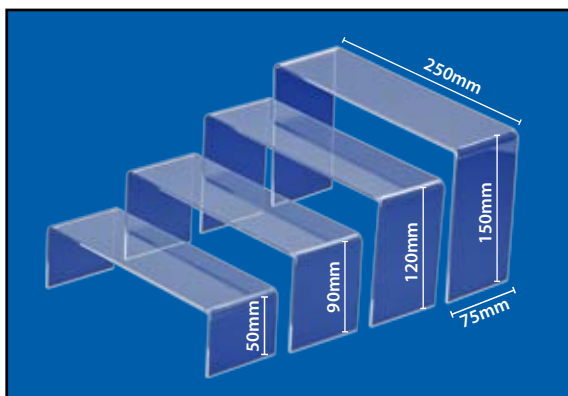

**50.308** 250x150x75mm Set of 4

## Coin Box

Coin box sign holder. Available with locker or without lock.

**Material:** Acrylic.



	QTY	N.W(kg)	G.W(kg)	C.B.M.	Size(mm)
Uni.	1	0.36	0.56	0.005	175x220x130

**13.099** Graphic size: 150x100mm

	QTY	N.W(kg)	G.W(kg)	C.B.M.	Size(mm)
Uni.	1	0.32	0.52	0.005	175x220x130

**13.100** Graphic size: 150x100mm

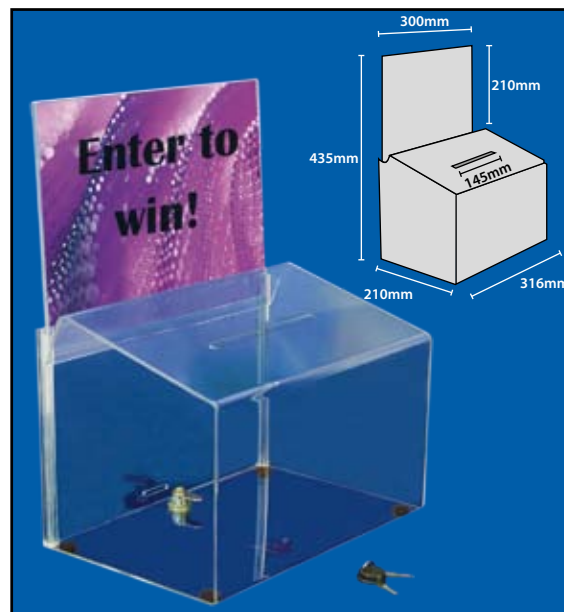

	QTY	N.W(kg)	G.W(kg)	C.B.M.	Size(mm)
Uni.	1	1.7	1.9	0.022	330x290x240

**13.124** Graphic size: 300x210mm



## Acrylic Hinge 200mm

Acrylic hinge 200mm length. Colour: transparent.

**Material:** Acrylic.

**10.943**      **Pack 20 Uni.**     

## Acrylic Hinge 100mm

Acrylic hinge 100mm length. Colour: transparent.

**Material:** Acrylic.

**10.944**      **Pack 20 Uni.**     

## Acrylic Hinge 65mm

Acrylic hinge 65mm length. Colour: transparent.

**Material:** Acrylic.

**10.945**      **Pack 20 Uni.**     

## Acrylic Hinge 45mm

Acrylic hinge 45mm length. Colour: transparent.

**Material:** Acrylic.

**10.946**      **Pack 20 Uni.**     

## Acrylic Hinge 30mm

Acrylic hinge 30mm length. Colour: transparent.

**Material:** Acrylic.

**10.947**      **Pack 20 Uni.**     

## Acrylic Hinge 25mm

Acrylic hinge 25mm length. Colour: transparent.

**Material:** Acrylic.

**10.948**      **Pack 20 Uni.**     

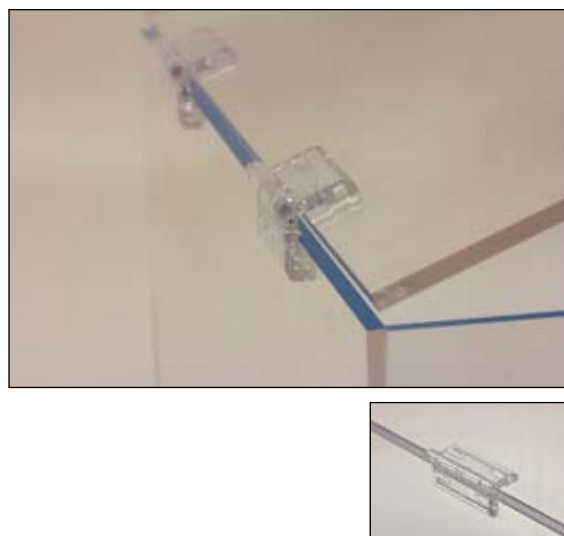
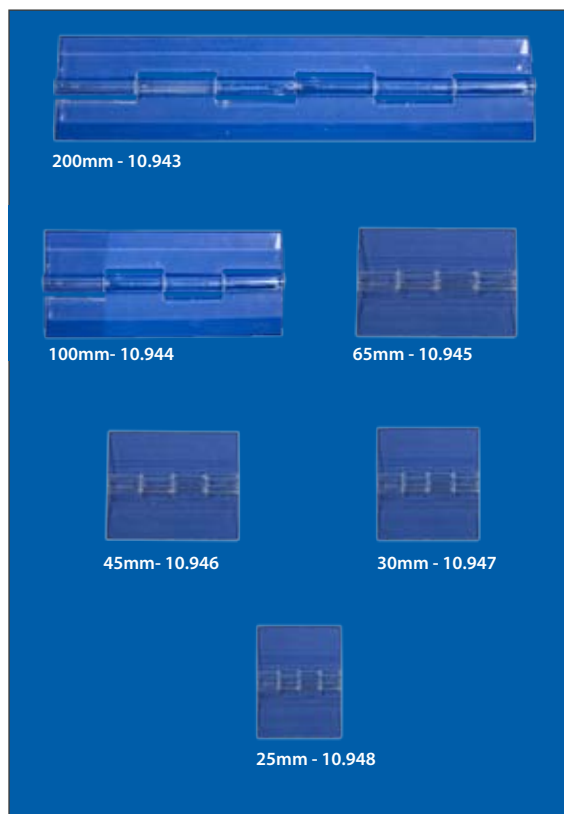

## Acrylic Hanger 2 Pieces



Acrylic hanger 2 pieces. Colour: transparent.

**Material:** Acrylic.

**10.949**      **Pack 20 Uni.**     

## Acrylic Hanger



Acrylic hanger. Colour: transparent.

**Material:** Acrylic.

**10.950**      **22x25mm**      **Pack 20 Uni.**

## Adhesive or Magnetic Showcard

Adhesive or magnetic showcard c-pocket PVC. Colour: transparent.  
Size: A3, A4, A5 and A6.

**Material:** PVC.

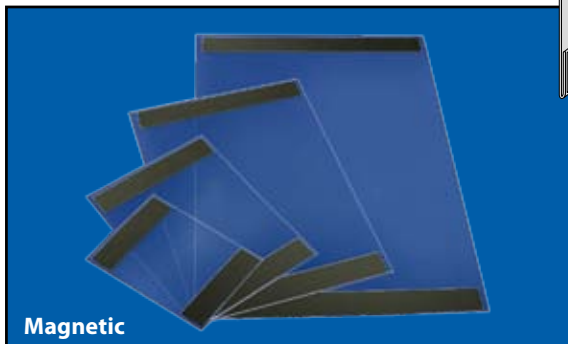
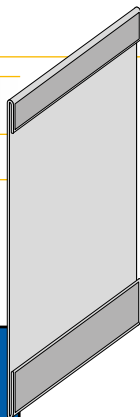

13.052	A3	Pack 10 Uni.	<input type="text"/>
13.053	A4	Pack 10 Uni.	<input type="text"/>
13.054	A5	Pack 10 Uni.	<input type="text"/>
13.055	A6	Pack 10 Uni.	<input type="text"/>

13.064	A3	Pack 10 Uni.	<input type="text"/>
13.065	A4	Pack 10 Uni.	<input type="text"/>
13.066	A5	Pack 10 Uni.	<input type="text"/>
13.067	A6	Pack 10 Uni.	<input type="text"/>

## Leaflet Dispenser "T"

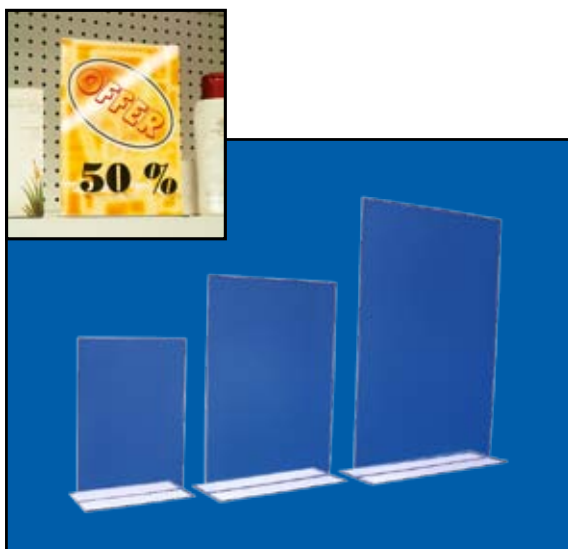

Leaflet dispenser. With magnetic strip. Sizes: A4, A5 and A6.

**Material:** PVC.

13.046	A4	Pack 10 Uni.	<input type="text"/>
13.047	A5	Pack 10 Uni.	<input type="text"/>
13.048	A6	Pack 10 Uni.	<input type="text"/>

## Leaflet Dispenser "L"

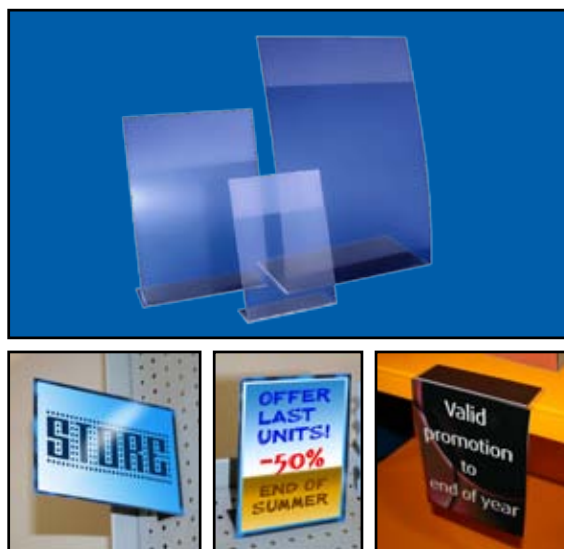

Leaflet dispenser. With magnetic strip. Sizes: A4, A5 and A6.

**Material:** PVC.

13.049	A4	Pack 10 Uni.	<input type="text"/>
13.050	A5	Pack 10 Uni.	<input type="text"/>
13.051	A6	Pack 10 Uni.	<input type="text"/>



## Leaflet Dispenser

Leaflet dispenser for shelves with adhesive strip. Easy and fast to assemble. Packing: 10 units.

**Material:** Transparent PVC 0.6mm.

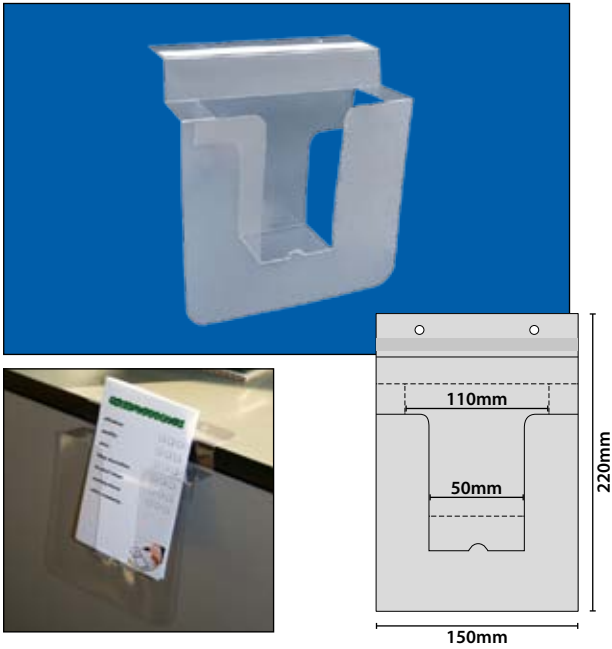

Leaflet dispenser. For adhering to shelves, adhesive strip on one side. Colour: transparent. Format: A6 portrait.

**Material:** PVC.

**13.060** 150x220mm Pack 10 Uni.

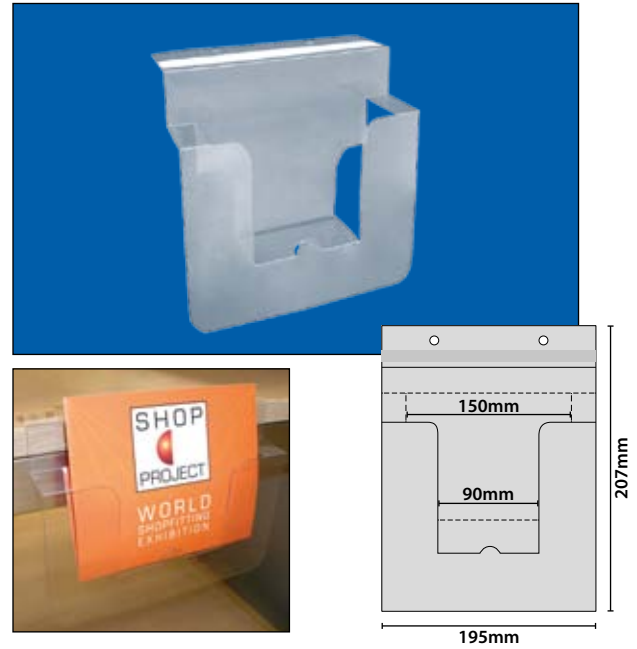

Leaflet dispenser. For adhering to shelves, adhesive strip on one side. Colour: transparent. Format: A6 landscape.

**Material:** PVC.

**13.061** 195x207mm Pack 10 Uni.



Leaflet dispenser. For adhering to shelves, adhesive strip on one side. Colour: transparent. Format: A5 portrait.

**Material:** PVC.

**13.062** 212x310mm Pack 10 Uni.

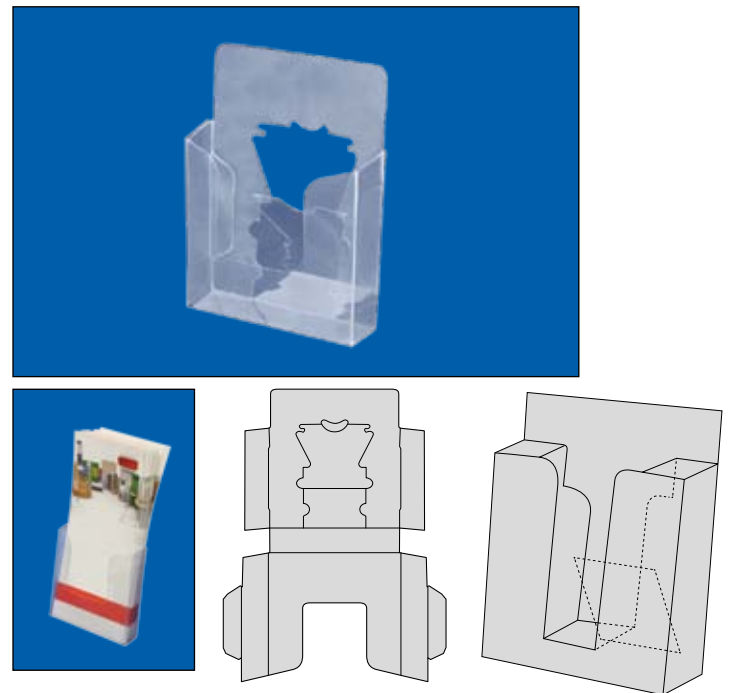

Leaflet dispenser. Easy to assemble. Format: A6 portrait.

**Material:** PVC.

**13.063** 106x140mm Pack 10 Uni.

# WIRE LEAFLET DISPENSER

## 7 Chromed Leaflet Dispenser

Leaflet holder. Chromed metal literature holders. Rubber feet protect countertop surfaces.

**Material:** Chromed wire, rubber.

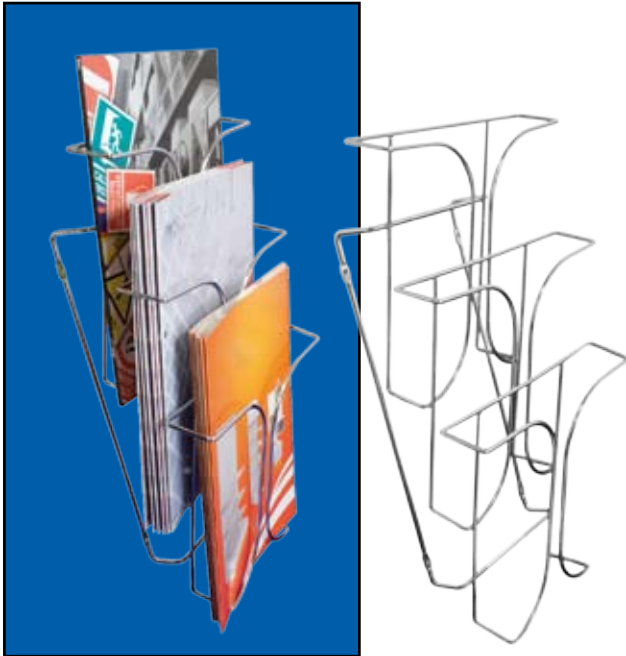

	QTY	N.W(kg)	G.W(kg)	C.B.M.	Size(mm)
Uni.	1	0.65	0.85	0.027	270x450x230
<b>13.118</b>	<b>3xA4</b>				



	QTY	N.W(kg)	G.W(kg)	C.B.M.	Size(mm)
Uni.	1	0.35	0.55	0.010	270x270x150
<b>13.117</b>	<b>1xA4</b>				



	QTY	N.W(kg)	G.W(kg)	C.B.M.	Size(mm)
Uni.	1	0.60	0.80	0.015	270x295x200
<b>13.120</b>	<b>4x 1/3 A4</b>				



	QTY	N.W(kg)	G.W(kg)	C.B.M.	Size(mm)
Uni.	1	0.70	0.90	0.029	270x470x230
<b>13.119</b>	<b>3xA4</b>				



	QTY	N.W(kg)	G.W(kg)	C.B.M.	Size(mm)
Uni.	1	0.25	0.45	0.004	135x220x140
<b>13.121</b>	<b>1/3 A4</b>				



barrier pole

## Barrier Pole with Retractable Tape

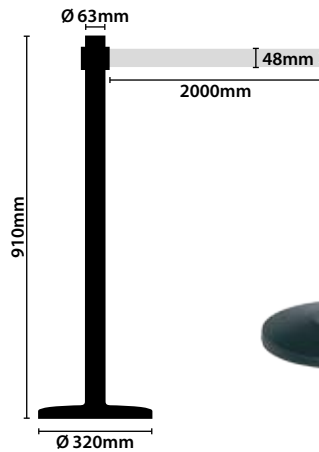

Barrier pole with retractable tape and connection point for 3 tapes. Dome base with 320mm diameter.

**Material:** Steel, plastic parts.

10.904

10.420

10.421 Ø 320x910mm Tube: Ø 63mm

10.903 Ø 320x910mm Tube: Ø 63mm

10.905 Ø 320x910mm Tube: Ø 63mm

Security lock

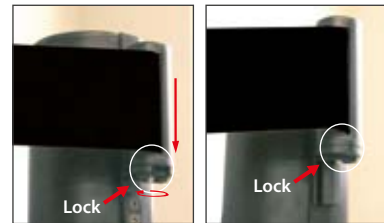

## Barrier Pole with Retractable Tape



Barrier pole with retractable tape. Ability to choose barrier pole and colour tape.

**Material:** Steel, plastic parts. **Colour:**

10.353 Ø 350x950mm Tube: Ø 70mm 9.35 Kg

## Retractable Belt Stanchions with Roller

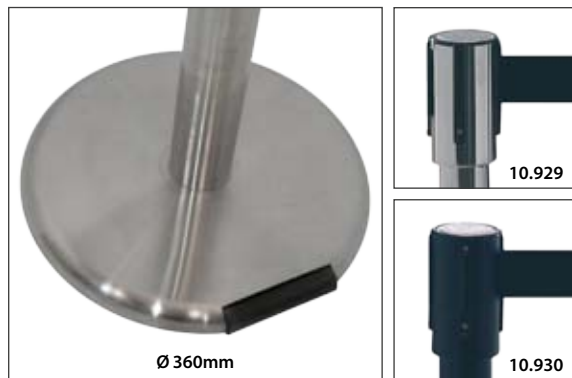

Retractable belt stanchions with roller. Cast iron. Flat base. Available in two colours.

**Material:** Plastic.

10.929		Silver	<input type="text"/>
10.930		Black	<input type="text"/>



## Barrier Pole Double Retractable Tape



Barrier pole with double retractable tape.

**Material:** Steel, plastic parts.

10.926		<input type="text"/>
10.927		Ø 320x910mm Tube: Ø 63mm
10.928		<input type="text"/>

## Wall Mountain Tensorope Support



Wall support with retractable tape. Tube diameter: 63mm. Height: 130mm

**Material:** Plastic.

10.918		<input type="text"/>
10.975		Ø 63x130mm

# BARRIER POLE

8

## Chrome Rope Barrier Queuing System



Rope barrier queuing system. High quality system queuing. (Rope not includes).

**Material:** Steel.

10.908  Ø 320x910mm Tube: Ø 50mm

10.910  Ø 320x1000mm Tube: Ø 50mm

## Brass Rope Barrier Queuing System

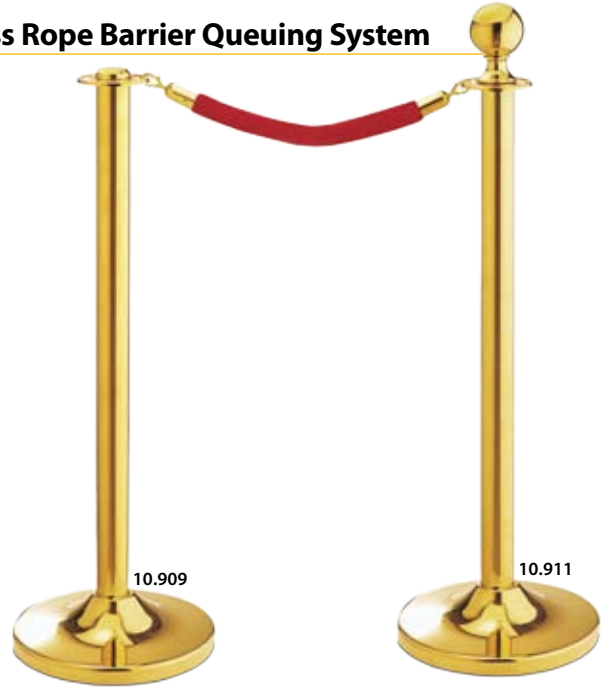

Rope barrier queuing system. High quality system queuing. (Rope not includes).

**Material:** Steel.

10.909  Ø 320x910mm Tube: Ø 50mm

10.911  Ø 320x1000mm Tube: Ø 50mm

## Rope Barrier Queuing System with Frame

Rope barrier queuing system with frame. Chrome or brass high quality system queuing. Graphic size portrait :420x320mm. Graphic size landscape: 320x420mm.

**Material:** Steel.



10.912  Ø 320x1440mm - Chrome

10.913  Ø 320x1440mm - Brass

10.914  Ø 320x1300mm - Chrome

10.915  Ø 320x1300mm - Brass

## Bowl and Connector



Bowl and connector.

**Material:** Plastic.



10.931	Ø 200mm	
10.932	Ø 300mm	

## Sign Board for Barrier Pole



Sign board for barrier pole.

**Material:** Titanium.

10.916		380x265mm	
10.917		380x265mm	

## Rope With Hook

Rope with hook. Length: 1500mm. Chrome or brass finished.

**Material:** Steel.

### Smooth Ropes



10.919	1500mm	
10.920	1500mm	
10.921	1500mm	
10.922	1500mm	

### Braided Ropes



10.923	1500mm	
10.977	1500mm	
10.924	1500mm	
10.925	1500mm	
10.976	1500mm	

## Lightweight Barrier Post

Lightweight barrier post. High: 900mm. Except item number 0489004 that the height is 800mm.

**Material:** Plastic.

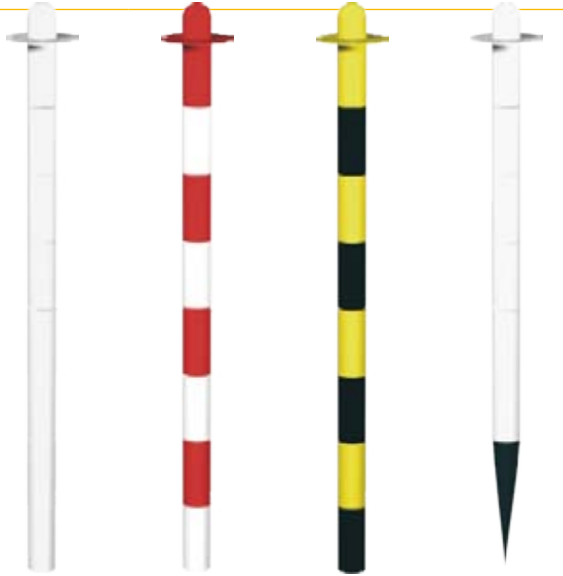

0489001      0489002      0489003      0489004

0489001	<input type="checkbox"/>			
0489002	<input checked="" type="checkbox"/>	<input type="checkbox"/>		
0489003	<input checked="" type="checkbox"/>	<input checked="" type="checkbox"/>	900mm	Pack 15 Uni. <input type="text"/>
0489004	<input type="checkbox"/>	<input type="checkbox"/>	800mm	Pack 2 Uni. <input type="text"/>

## Plastic Chain



Plastic chain. Length: 25m. Two different colours and 5mm and 8mm thickness are available.

**Material:** Plastic.

0489011	<input checked="" type="checkbox"/>	<input type="checkbox"/>	5mm	25m	Pack 4 Uni.	<input type="text"/>
0489012	<input checked="" type="checkbox"/>	<input checked="" type="checkbox"/>	5mm	25m	Pack 4 Uni.	<input type="text"/>
0489008	<input checked="" type="checkbox"/>	<input type="checkbox"/>	8mm	25m	Pack 4 Uni.	<input type="text"/>
0489009	<input checked="" type="checkbox"/>	<input checked="" type="checkbox"/>	8mm	25m	Pack 4 Uni.	<input type="text"/>
0489010	<input type="checkbox"/>	<input type="checkbox"/>	8mm	25m	Pack 4 Uni.	<input type="text"/>



## Rubber Base - Water Base

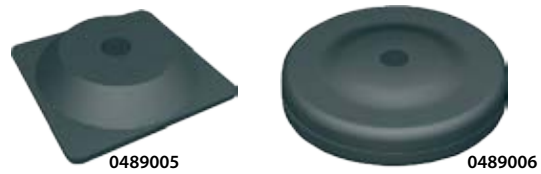

Two different base for plastic barrier pole.

**Material:** Plastic.

0489005	300x300mm	Pack 15 Uni.	<input type="text"/>
0489006	Ø 300mm	Pack 15 Uni.	<input type="text"/>

## Chain Connectors



Chain connector for plastic chain.

**Material:** Plastic.

0489015	5mm	Pack 25 Uni.	<input type="text"/>
0489014	8mm	Pack 25 Uni.	<input type="text"/>

## Reflective Sign



Hanging reflective sign.

**Material:** Plastic.

0489016	140x105mm	Pack 10 Uni.	<input type="text"/>
---------	-----------	--------------	----------------------



## Cones

Cones.

**Material:** Plastic.



0489017



0489018



0489019

0489017  300mm Pack 20 Uni.

0489018  300mm Pack 20 Uni.

0489019  300mm Pack 20 Uni.



0489023  500mm Pack 10 Uni.

0489020  500mm Pack 10 Uni.

0489021  500mm Pack 10 Uni.

0489022  500mm Pack 10 Uni.

## Cone Tops



Cone Tops.

**Material:** Plastic.

**Colour:**  

0489024 Pack 10 Uni.

## Tape Signalling

Tape signalling.

**Material:** Plastic.



0479001  80mm 200m Pack 5 Uni.



0479004  80mm 200m Pack 5 Uni.

## Stop Sign

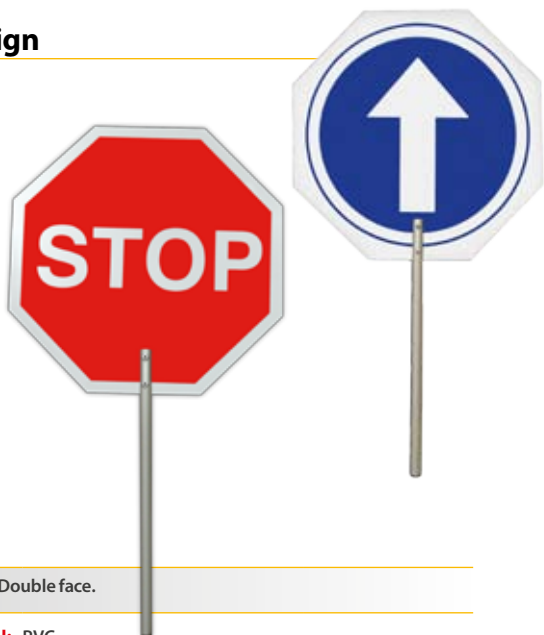

Stop sign. Double face.

**Material:** PVC.

0080011 Pack 3 Uni.

## Restrict Access to Parking Spaces



Aluminium restrict access to parking whit lock.

**Material:** Aluminium.

0080010 400x720mm



LOCKABLE





9

plv

## ABS Frames



Showcard ABS frames. Available in different colours. Strong plastic frames with narrow side entry slots to take the following card sizes.

**Material:** Plastic.

Please inform us about the size and colour.



12.053	105x148mm	A6	Pack 10 Uni.	<input type="text"/>
12.054	148x210mm	A5	Pack 10 Uni.	<input type="text"/>
12.055	210x297mm	A4	Pack 10 Uni.	<input type="text"/>
12.056	297x420mm	A3	Pack 10 Uni.	<input type="text"/>

## Poster Protectors

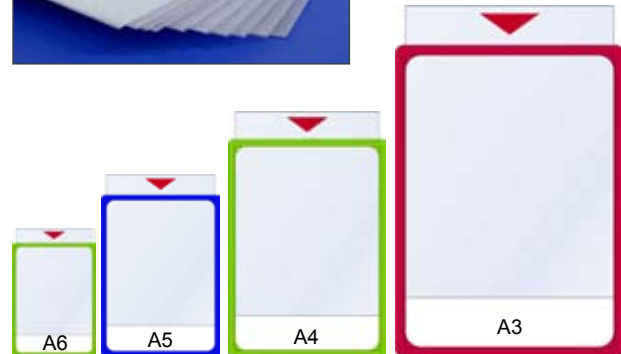

Poster protectors. Clear plastic non-reflective poster protector that insert into frames.

**Material:** Plastic.

12.057	A6	Pack 10 Uni.	<input type="text"/>
12.058	A5	Pack 10 Uni.	<input type="text"/>
12.059	A4	Pack 10 Uni.	<input type="text"/>
12.060	A3	Pack 10 Uni.	<input type="text"/>

## Showcard Stand Extendable

Frame and T-piece in virtually unbreakable plastic. Aluminium tube, adjustable. Frames can be used portrait or landscape. Frames not included.

**Material:** Aluminium, plastic parts and Plastic or steel.

### Plastic base

12.239	<input type="checkbox"/>	150+150	Pack 10 Uni.	<input type="text"/>
12.240	<input checked="" type="checkbox"/>	150+150	Pack 10 Uni.	<input type="text"/>
12.062	<input type="checkbox"/>	300+300	Pack 10 Uni.	<input type="text"/>
12.063	<input checked="" type="checkbox"/>	300+300	Pack 10 Uni.	<input type="text"/>
12.065	<input type="checkbox"/>	500+500	Pack 10 Uni.	<input type="text"/>
12.066	<input checked="" type="checkbox"/>	500+500	Pack 10 Uni.	<input type="text"/>
12.242	<input type="checkbox"/>	750+750	Pack 10 Uni.	<input type="text"/>
12.243	<input checked="" type="checkbox"/>	750+750	Pack 10 Uni.	<input type="text"/>

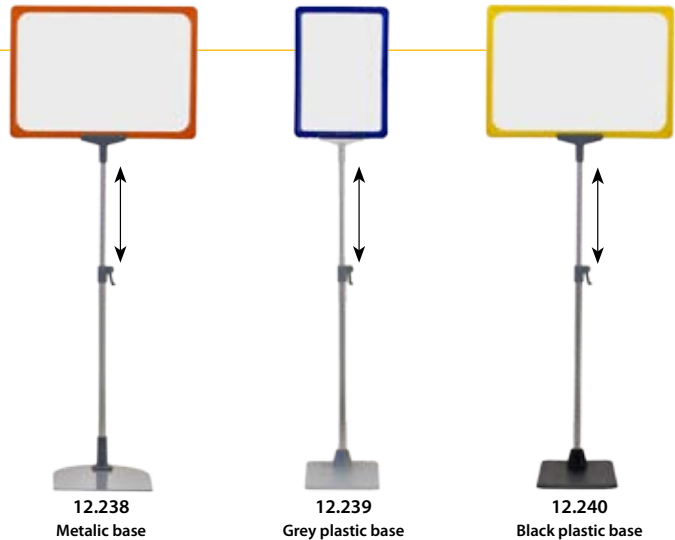

### Metalic base

12.238	150+150	Pack 10 Uni.	<input type="text"/>
12.061	300+300	Pack 10 Uni.	<input type="text"/>
12.064	500+500	Pack 10 Uni.	<input type="text"/>
12.241	750+750	Pack 10 Uni.	<input type="text"/>

## Clamp Support for Pallet

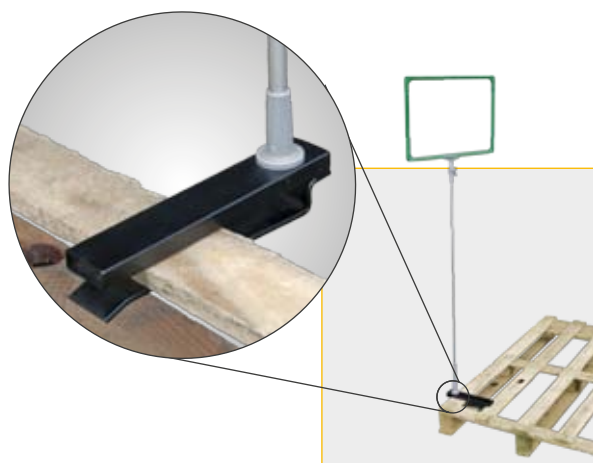

Clamp support for telescopic.

**Material:** Steel.

12.400 250mm Pack 10 Uni.

## Showcard Stand Extendable

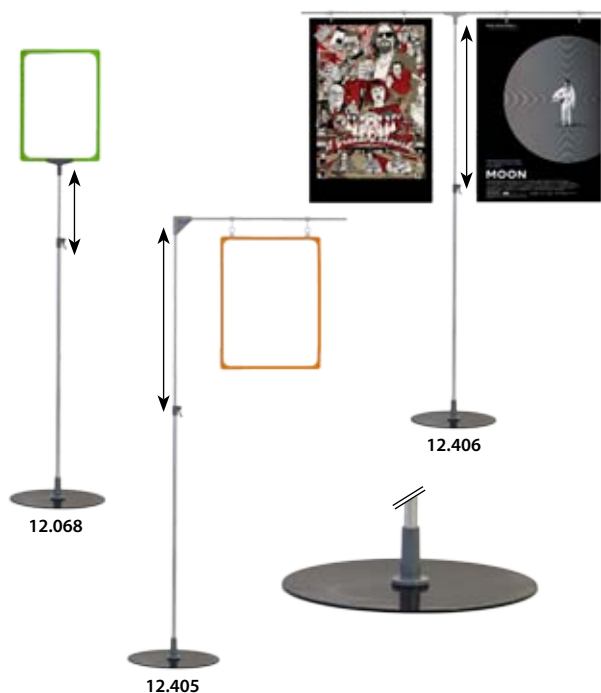

Frame and T-piece in virtually unbreakable plastic. Aluminium tube, adjustable (950+950). Frames can be used portrait or landscape. With 240mm black flat round metallic base. Maximum height: 1900mm. Frame not included.

**Material:** Aluminium, plastic parts, steel.

12.068 950+950 Pack 10 Uni.

12.406 950+950 Pack 10 Uni.

12.405 950+950 Pack 10 Uni.

## Showcard Stand with Spring

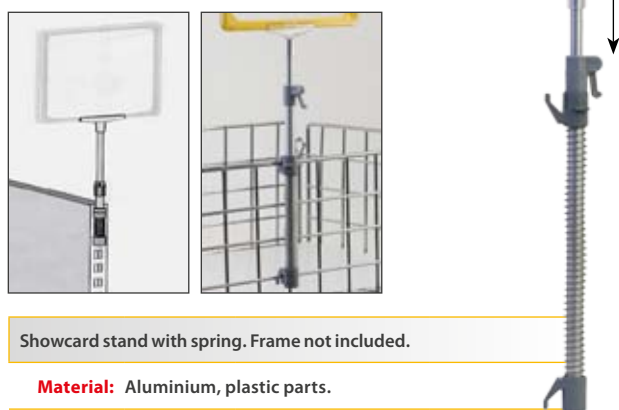

Showcard stand with spring. Frame not included.

**Material:** Aluminium, plastic parts.

12.069 250mm Pack 10 Uni.

## Showcard Stand Extendable "L"

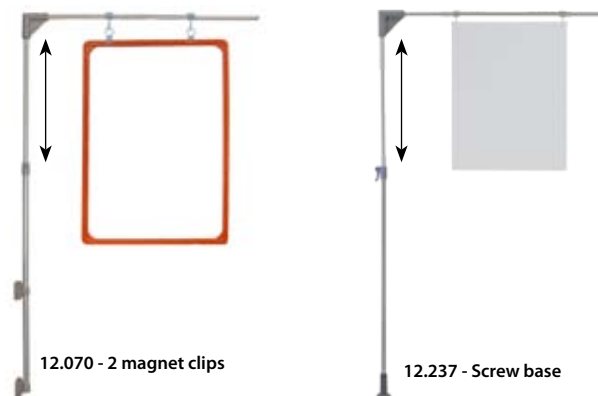

12.070 - 2 magnet clips

12.237 - Screw base

Aluminium telescopic support. Adjustable height 500+500mm. Two models are available. Frame not included.

**Material:** Aluminium, plastic parts.

12.070 Pack 20 Uni.

12.237 Pack 20 Uni.

## Showcard Stand Extendable "T"

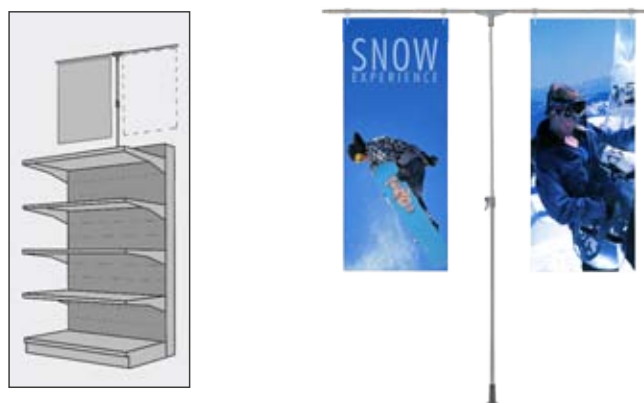

"T" aluminium telescopic support 500+500mm. Frame not included.

**Material:** Aluminium, plastic parts.

12.075 Pack 20 Uni.

## Showcard Stand for Shelf

Differs graphics support for shelf-system.

**Material:** Plastic or steel.

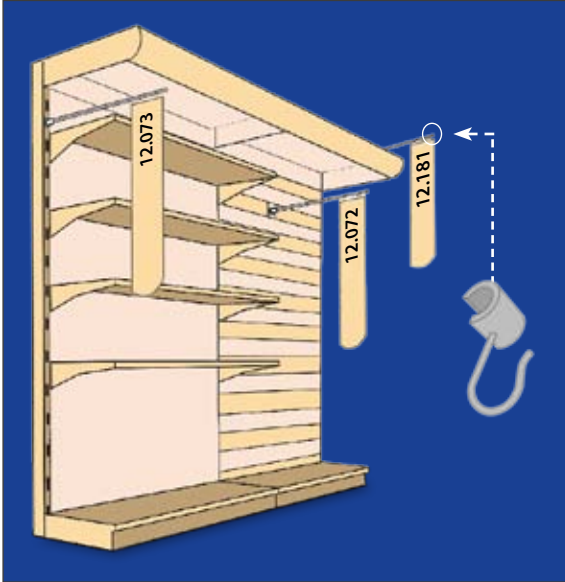

### Slatwall single hook



12.072 300+300mm Pack 10 Uni.

### Upright single hook



12.073 300+300mm Pack 10 Uni.

### Aluminium banner holder with magnet



12.181 300+300mm Pack 10 Uni.

12.231 400+400mm Pack 10 Uni.

12.300 500+500mm Pack 10 Uni.

## Single hook for "L" tubes

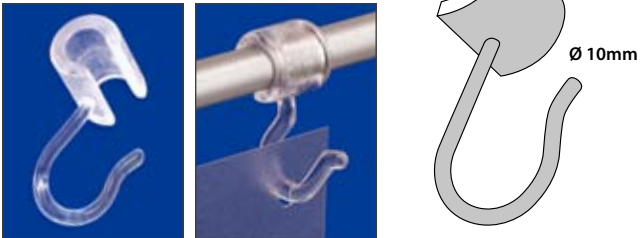

Single plastic hook for anodized aluminium tubes.

**Material:** Plastic.

12.076 Pack 20 Uni.

## Cardboard Clamp

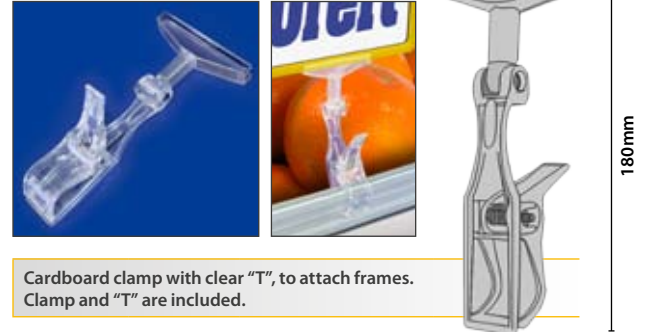

Cardboard clamp with clear "T", to attach frames. Clamp and "T" are included.

**Material:** Plastic.

12.291 180mm Pack 20 Uni.

## Graphic Support

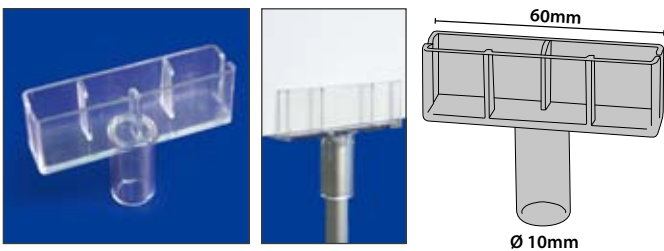

Graphic support for telescopic tube.

**Material:** Plastic.

12.338 Pack 25 Uni.

## "T"



"T" pieces for mounting frames to tubes, rods and magnetic bases.

**Material:** Plastic.

**Colour:**     clear

12.077 Pack 20 Uni.

## Tube Clip

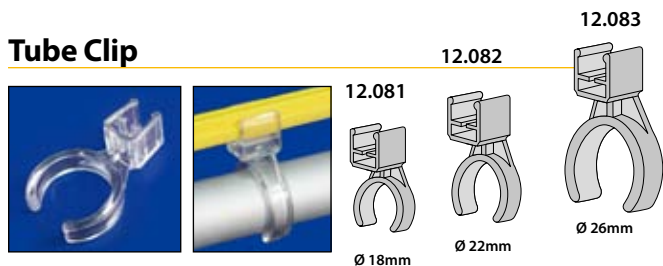

Tube clip. Transparent colour.

**Material:** Plastic.

12.081	Ø 18mm	Pack 20 Uni.	<input type="text"/>
12.082	Ø 22mm	Pack 20 Uni.	<input type="text"/>
12.083	Ø 26mm	Pack 20 Uni.	<input type="text"/>

## Wall Fix Clip

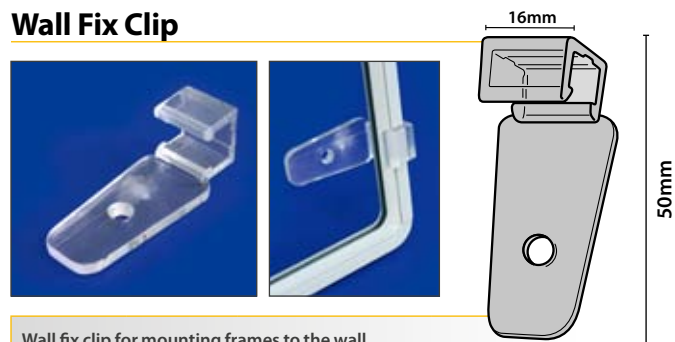

Wall fix clip for mounting frames to the wall.

**Material:** Plastic.

12.080	Pack 20 Uni.	<input type="text"/>
--------	--------------	----------------------

## Connecting Clips

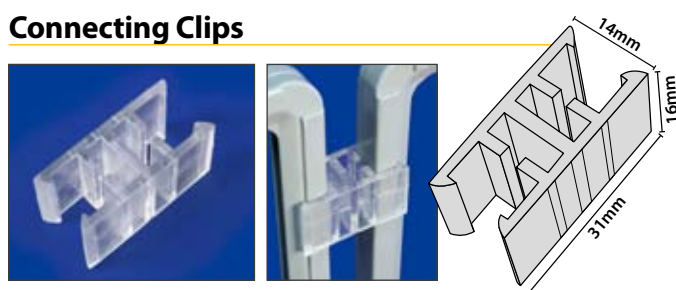

Connecting clips. For connecting some frames.

**Material:** Plastic.

12.087	Pack 20 Uni.	<input type="text"/>
--------	--------------	----------------------

## Basket Clip

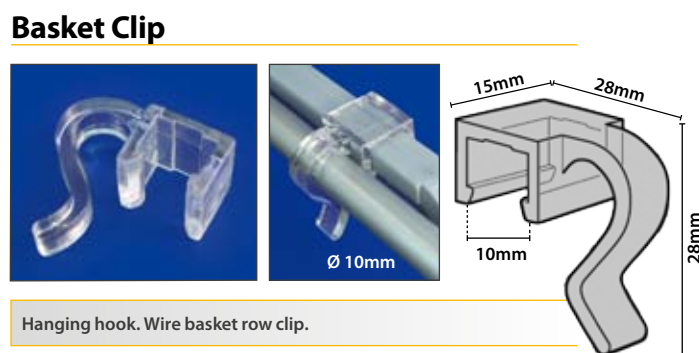

Hanging hook. Wire basket row clip.

**Material:** Plastic.

12.084	Pack 20 Uni.	<input type="text"/>
--------	--------------	----------------------

## Promo Showcard Clip

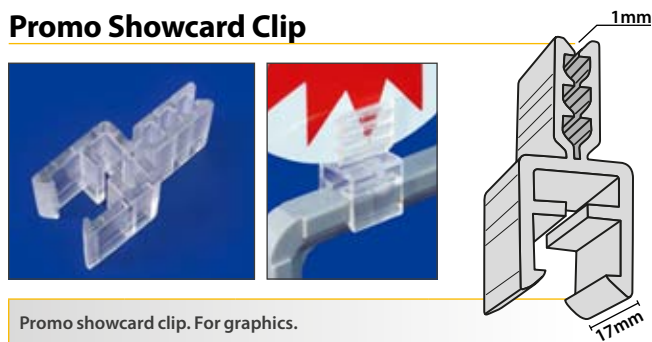

Promo showcard clip. For graphics.

**Material:** Plastic.

12.088	Pack 20 Uni.	<input type="text"/>
--------	--------------	----------------------

## Clip for Ceiling-Rail



Clip for ceiling-rail

**Material:** Plastic.

12.089	Pack 20 Uni.	<input type="text"/>
--------	--------------	----------------------

## Ring Clip

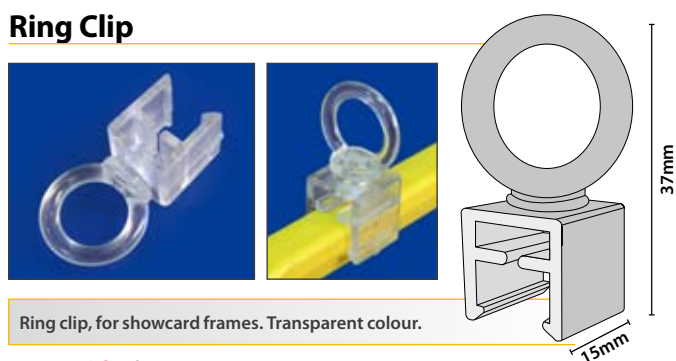

Ring clip, for showcard frames. Transparent colour.

**Material:** Plastic.

12.090	Pack 20 Uni.	<input type="text"/>
--------	--------------	----------------------

## Hook Clip 10mm

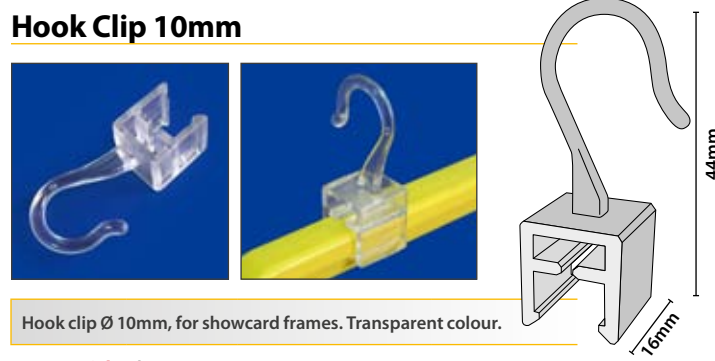

Hook clip Ø 10mm, for showcard frames. Transparent colour.

**Material:** Plastic.

12.091	Pack 20 Uni.	<input type="text"/>
--------	--------------	----------------------

## Tube Clamp

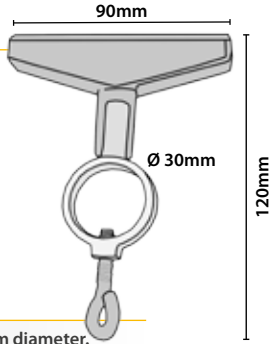

For attaching showcard frames to tubing with 30mm diameter. Includes transparent "T" piece.

**Material:** Steel, plastic.

12.292 Ø 30mm Pack 20 Uni.

## Hook Clip 20mm

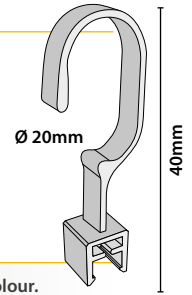
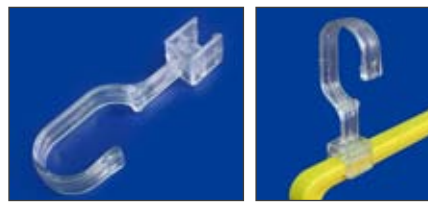

Hook clip Ø 20mm, for showcard frames. Transparent colour.

**Material:** Plastic.

12.092 Pack 20 Uni.

## Base Support Clip

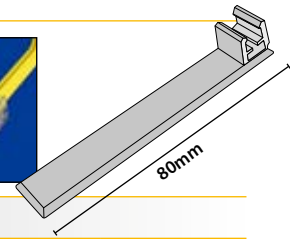

Frame base support clip.

**Material:** Plastic.

12.093 Pack 10 Uni.

## Lateral Clip

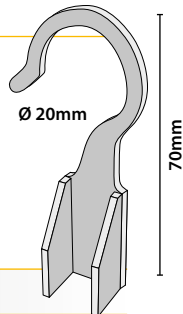

Hook with lateral clip. Transparent colour.

**Material:** Plastic.

12.094 Pack 20 Uni.  $\leftarrow$  10 Uni.  $\rightarrow$  10 Uni.

## Magnetic "T" Base

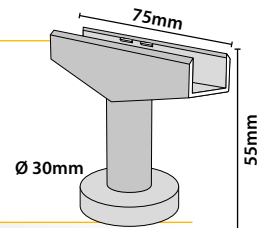
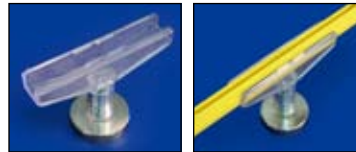

Magnetic base with short T-connector. Frame not included.

**Material:** Steel, plastic.

12.079 Pack 20 Uni.

## Magnetic Clip Connector

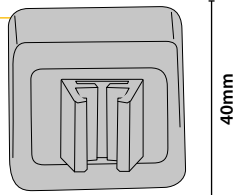
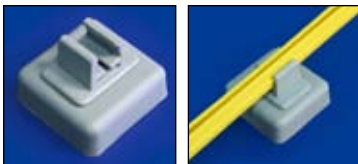

Magnetic base with clip connector.

**Material:** Plastic.

12.096 Pack 20 Uni.

## Medium Magnetic Clip

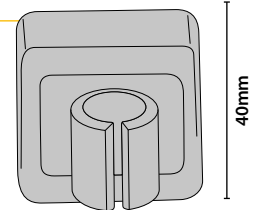

Medium-magnetic clip for aluminium tube.

**Material:** Plastic.

12.097 Pack 20 Uni.

## End-Magnetic Clip

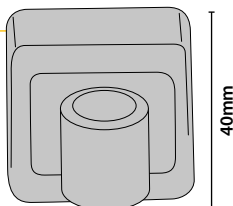

End-magnetic clip for aluminium tube.

**Material:** Plastic.

12.098 Pack 20 Uni.

## Magnetic Clip for Frames

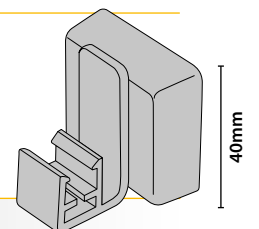
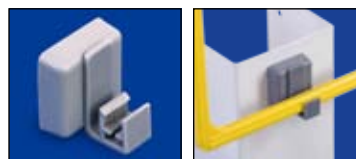

Magnetic feet clip for showcard frames.

**Material:** Plastic.

12.099 Pack 20 Uni.



## Clear Frames

Lightweight showcard frame, with narrow side entry slots to take the following card sizes. Clear colour. Different sizes are available.

**Material:** Plastic. **Colour:**  clear

12.336	74x105mm	A7	Pack 10 Uni.	<input type="checkbox"/>
12.322	105x148mm	A6	Pack 10 Uni.	<input type="checkbox"/>
12.323	148x210mm	A5	Pack 10 Uni.	<input type="checkbox"/>
12.324	105x297mm	½A4	Pack 10 Uni.	<input type="checkbox"/>
12.325	210x297mm	A4	Pack 10 Uni.	<input type="checkbox"/>



## Poster Protectors



Poster protectors. Clear plastic non-reflective poster protector that insert into frames.

**Material:** Plastic.

12.337	A7	Pack 10 Uni.	<input type="checkbox"/>
12.057	A6	Pack 10 Uni.	<input type="checkbox"/>
12.058	A5	Pack 10 Uni.	<input type="checkbox"/>
12.328	½A4	Pack 10 Uni.	<input type="checkbox"/>
12.059	A4	Pack 10 Uni.	<input type="checkbox"/>

## Hanging Hook

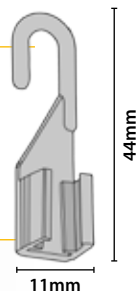

Hanging hook - long swivel. For hook suspension with top entry display. Clear colour.

**Material:** Plastic.

12.095	Pack 20 Uni.	◀ 10 Uni. ▶ 10 Uni.	<input type="checkbox"/>
--------	--------------	------------------------	--------------------------

## Frame connector

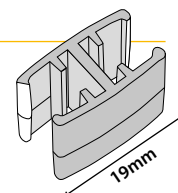

Frame connector. Connects same series frames.

**Material:** Plastic.

12.334	Pack 20 Uni.	<input type="checkbox"/>
--------	--------------	--------------------------

## Promotion Clip

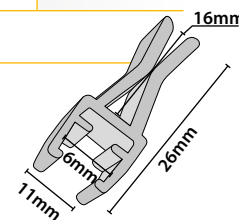

Promotion card clip. To attach sign card to showcard frames.

**Material:** Plastic.

12.332	Pack 20 Uni.	<input type="checkbox"/>
--------	--------------	--------------------------

## Hanging Hook

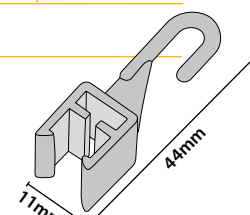

Hook clip - short. For hook suspension with side entry display. Clear colour.

**Material:** Plastic.

12.335	Pack 20 Uni.	<input type="checkbox"/>
--------	--------------	--------------------------

## Base Clip

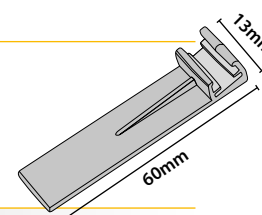
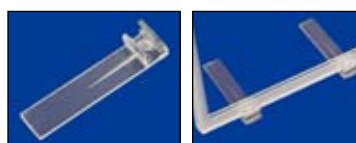

Frame base support clip. To stand frames inclined.

**Material:** Plastic.

12.333	Pack 20 Uni.	<input type="checkbox"/>
--------	--------------	--------------------------

# SIGN CLIP

9

## "B" Big Clip

Sign Clip. With power clip and power clamp. Width of clamp: 25mm.

**Material:** Plastic.

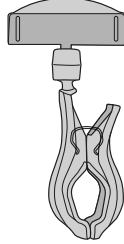
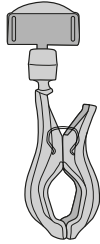

12.004 Pack 25 Uni.

12.007 Pack 25 Uni.

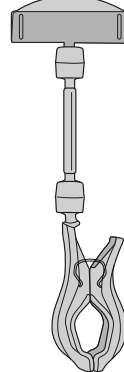

12.008 Pack 25 Uni.

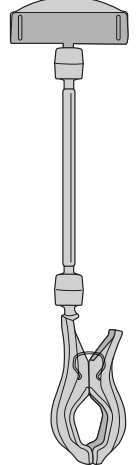

12.009 Pack 25 Uni.

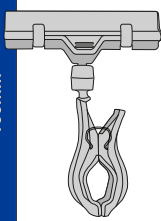
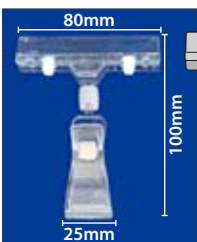

12.000 Pack 25 Uni.

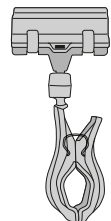
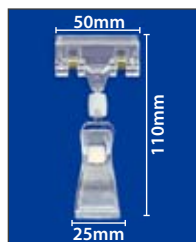

12.001 Pack 25 Uni.

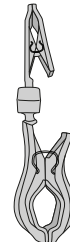
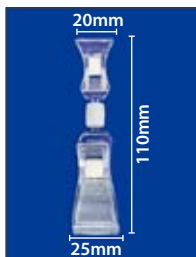

12.010 Pack 25 Uni.

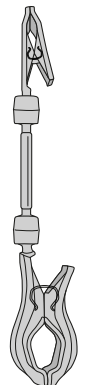

12.011 Pack 25 Uni.

## "C" Medium Clip

Sign Clip. With power clip and power clamp. Width of clamp: 20mm.

**Material:** Plastic.

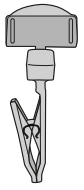
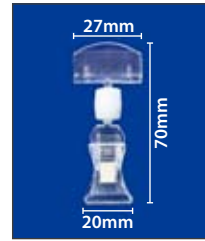
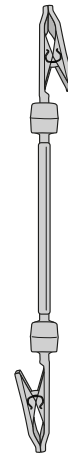
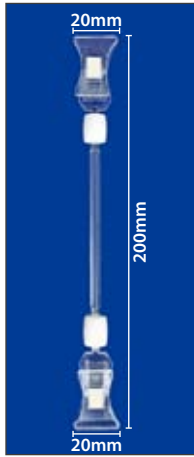
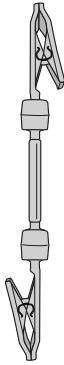
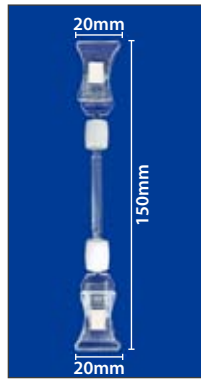
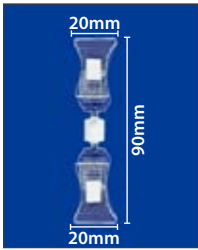

12.015 Pack 25 Uni.

12.016 Pack 25 Uni.

12.017 Pack 25 Uni.

12.020 Pack 25 Uni.

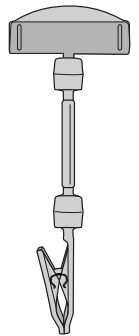
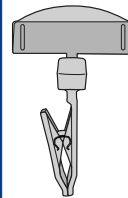
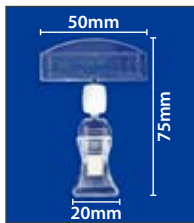
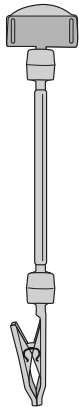
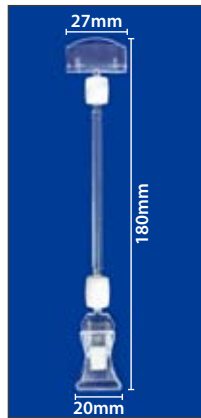
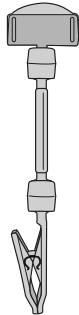

12.021 Pack 25 Uni.

12.022 Pack 25 Uni.

12.025 Pack 25 Uni.

12.026 Pack 25 Uni.

## "G" Magnetic Clip

Sign clip with 20mm magnetic base.

**Material:** Plastic.

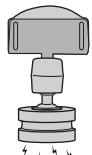
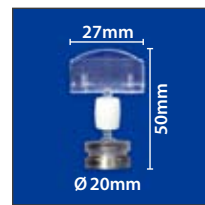
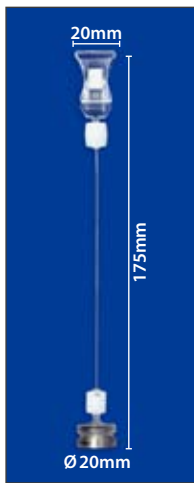
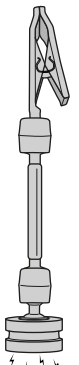

12.029 Pack 25 Uni.

12.030 Pack 25 Uni.

12.031 Pack 25 Uni.

12.034 Pack 25 Uni.

## "H" Table Clip Ø 90mm

Sign clip with large round base 90mm diameter.

**Material:** Plastic.

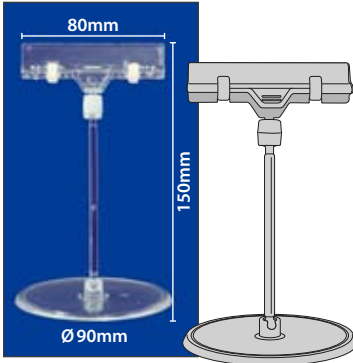

12.035 Pack 25 Uni.

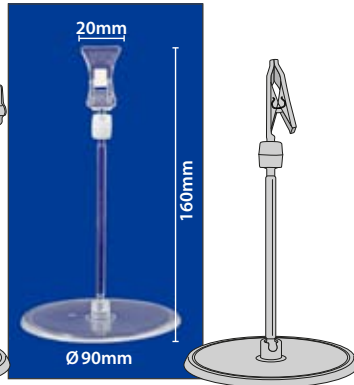

12.036 Pack 25 Uni.

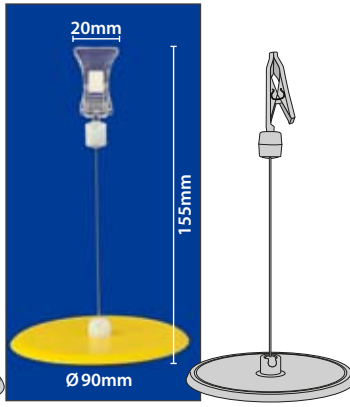

12.037 Pack 25 Uni.

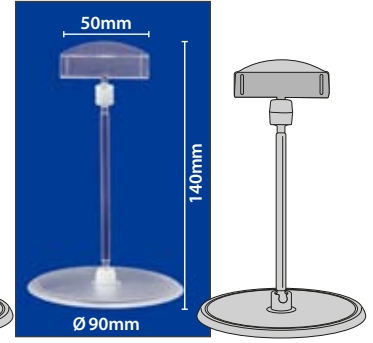

12.038 Pack 25 Uni.

## "I" Table Clip Ø 55mm

Sign clip with round base 55mm diameter.

**Material:** Plastic.

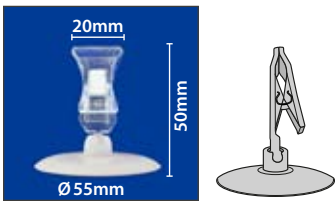

12.039 Pack 25 Uni.

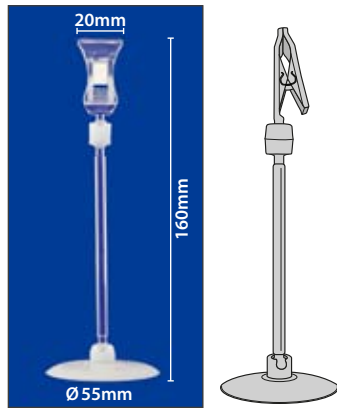

12.040 Pack 25 Uni.

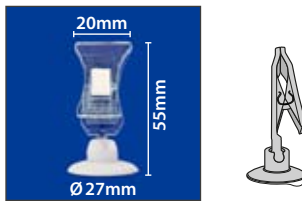

12.042 Pack 25 Uni.

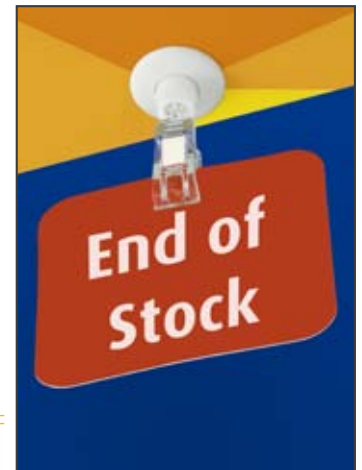

## "K" Suction Clip

Sign clip with foot 40mm diameter.

**Material:** Plastic.

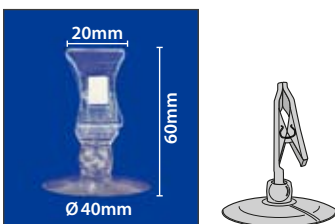

12.045 Pack 25 Uni.

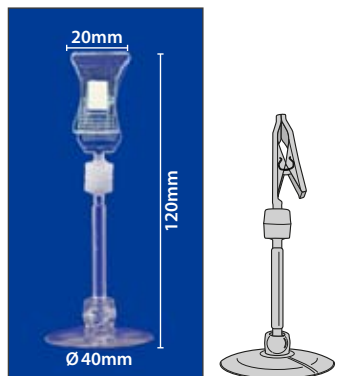

12.046 Pack 25 Uni.

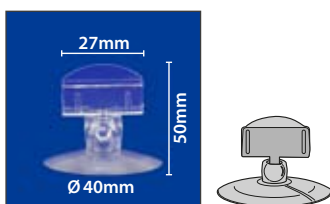

12.048 Pack 25 Uni.

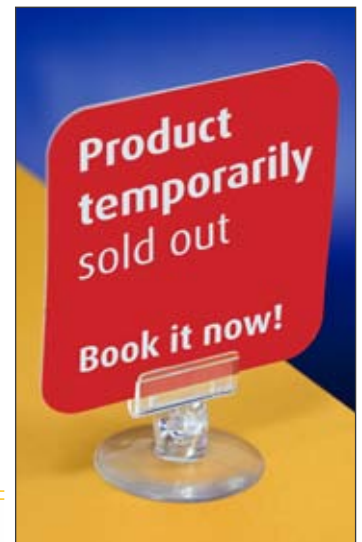

## "Q" Sign Support

Sign support. Telescopic sign support with 3 different heights.

**Material:** Steel, plastic parts.

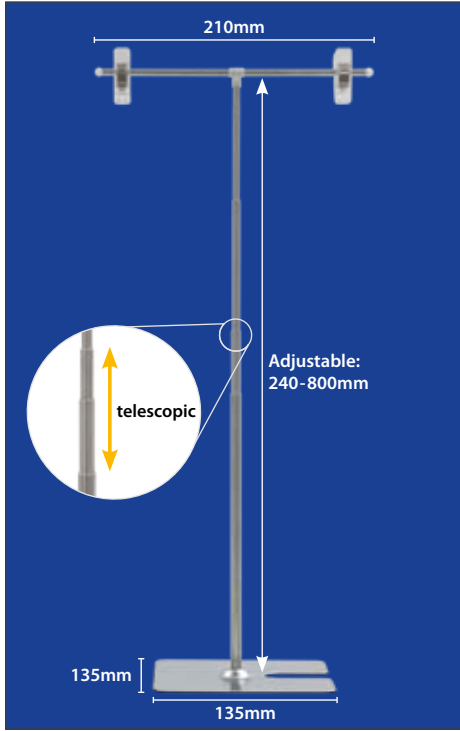
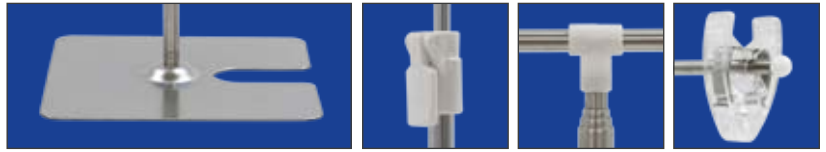

**12.050** Pack 10 Uni.

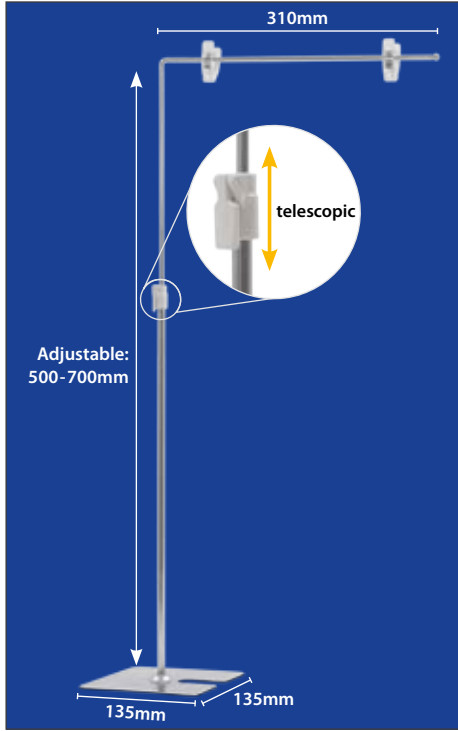

**12.051** Pack 10 Uni.

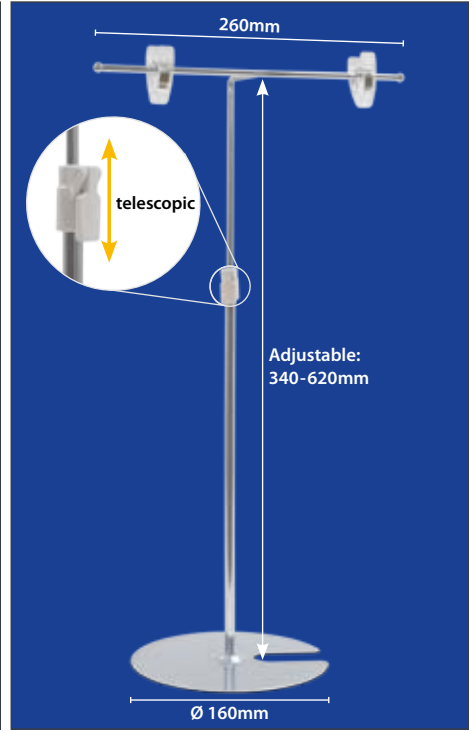

**12.052** Pack 10 Uni.

## Clip Strip

Polypropylene strips. Products can be hooked or clipped on.

**Material:** Plastic.

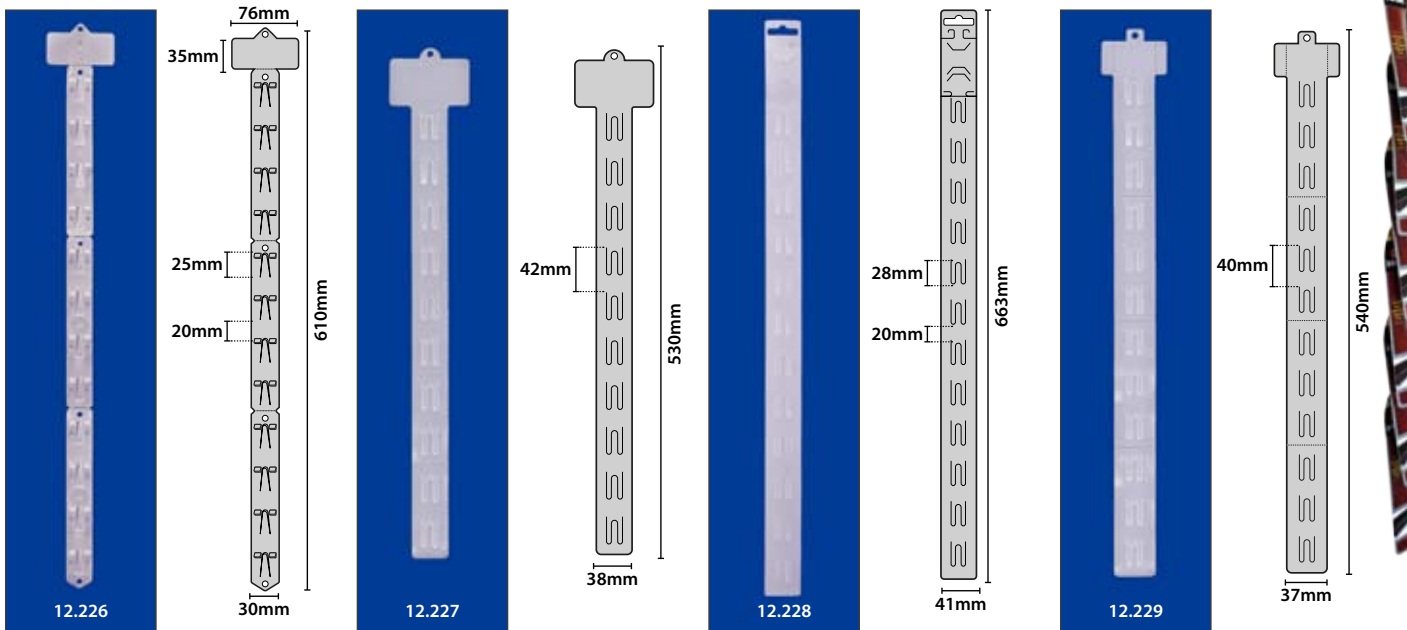

**12.226** Pack 50 Uni.

**12.227** Pack 50 Uni.

**12.228** Pack 50 Uni.

**12.229** Pack 50 Uni.

## Rotating Ceiling Button

White polypropylene self adhesive ceiling button. Eye rotates through 360°.

**Material:** Plastic.



12.113 30x30mm Pack 100 Uni.



12.384 Ø 40mm Pack 100 Uni.

## Ceiling Hook



White polypropylene self adhesive hook with 24x24mm square base.

**Material:** Plastic.

12.131 24x24mm Pack 100 Uni.

## Horizontal Clip for Ceiling



Clear polypropylene 20x20mm base. Clips to ceiling tees.

**Material:** Plastic.

12.133 20x20mm Pack 100 Uni.

## Vertical Clip for Ceiling



Ceiling tee hanger. Natural polypropylene clip on hanger with 20x15mm.

**Material:** Plastic.

12.132 25x20mm Pack 100 Uni.

## Mobile Button

White polypropylene self adhesive ceiling button with loop.

**Material:** Plastic.

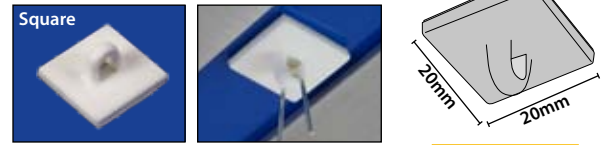

12.129 20x20mm Pack 100 Uni.



12.130 37x26mm Pack 100 Uni.



12.368 40x20mm Pack 100 Uni.



12.301 Ø 18mm Pack 100 Uni.

## Adhesive Multiclip



Sign gripper. White plastic 25x25mm base with adhesive pad.

**Material:** Plastic.

12.134 25x25mm Pack 100 Uni.

## Pen Clip



Pen holder. Suitable for standard pens and pencils, with foam adhesive. Colour: white.

**Material:** Plastic.

12.182 12x15mm Pack 100 Uni.

## "S" Hook

White plastic hook 55mm length.

**Material:** Plastic.

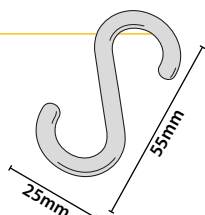

12.293 55mm Pack 50 Uni.

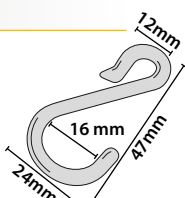

12.377 47mm Pack 50 Uni.

## "Fishing Clip"

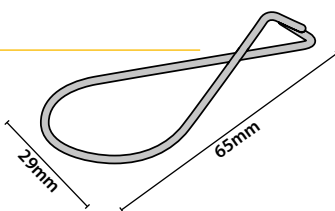

Spring metal clip for ceiling tee grids. 65mm long.

**Material:** Steel.

12.136 65x29mm Pack 100 Uni.

## "Spider Clip"

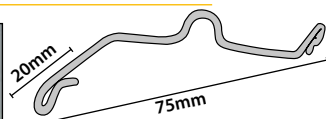

Suspended ceiling clip. For hanging poster, showcard, etc. from suspended ceiling.

**Material:** Steel.

12.135 75x20mm Pack 100 Uni.

## "Easy Clip"

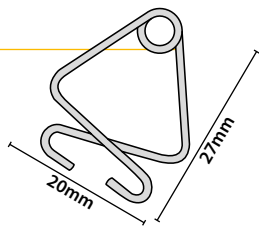

Spring metal clip for ceiling tee grids.

**Material:** Steel.

12.387 20x27mm Pack 100 Uni.

## Arrow Hole

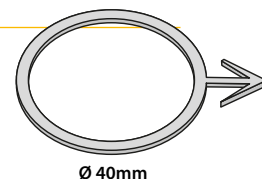

Plastic loop with arrow to push through hole. 40mm diameter.

**Material:** Plastic.

12.296 Ø 40mm Pack 50 Uni.

## Adjustable Ceiling

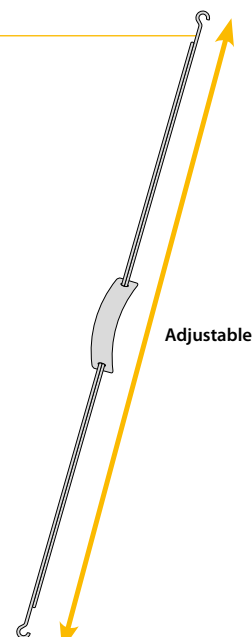

Adjustable ceiling hook. Two part ceiling hook. Adjustable 2m.

**Material:** Steel.

12.151 1000-2000mm Pack 50 Uni.

## Nylon Wire with Hook

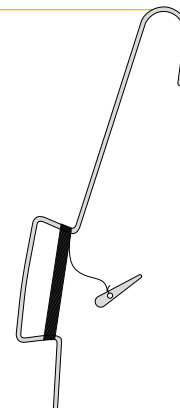

Metal hook and nylon wire with metal tip. Hook ±105mm, nylon ±1200mm.

**Material:** Steel, nylon.

12.137 Pack 100 Uni.

## Extending Wire Hook

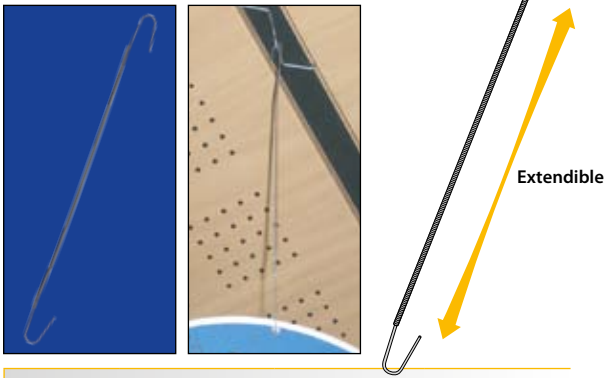

Pull out to required length. Remains in desired position.

**Material:** Steel.

12.138	160-1300mm	Pack 100 Uni.	<input type="text"/>
12.139	210-1400mm	Pack 100 Uni.	<input type="text"/>
12.140	320-2500mm	Pack 50 Uni.	<input type="text"/>

## Plastic Clasp

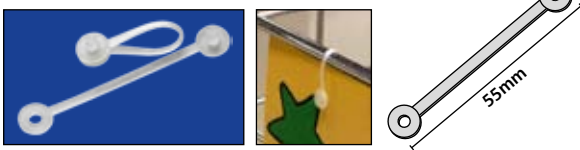

Plastic clasp. Length 55mm.

**Material:** Plastic.

12.376	55mm	Pack 100 Uni.	<input type="text"/>
--------	------	---------------	----------------------

## "C" Hook



"C" hook. Bright metal plated.

**Material:** Steel.

12.155	80mm	Pack 100 Uni.	<input type="text"/>
12.156	39mm	Pack 100 Uni.	<input type="text"/>

## Hook for Clip Strip



Hook for clip strip.

**Material:** Steel.

12.157	38mm	Pack 100 Uni.	<input type="text"/>
--------	------	---------------	----------------------

## Double Ended Hooks

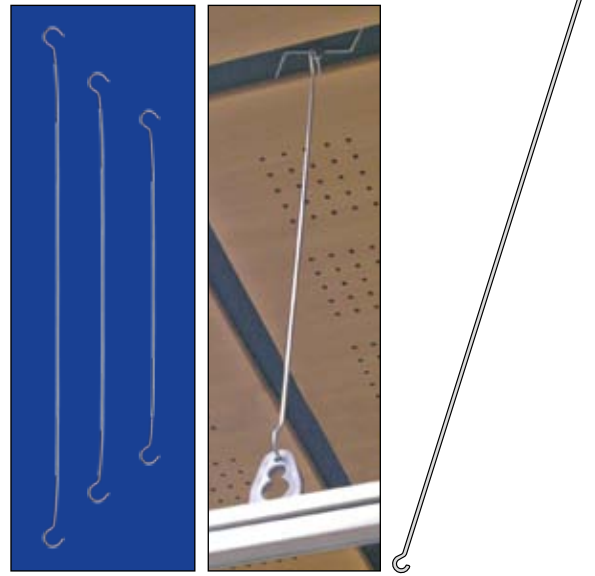

Bright galvanised double ended hooks for suspending and connecting signs.

**Material:** Steel.

12.141	100mm	Pack 50 Uni.	<input type="text"/>
12.142	150mm	Pack 50 Uni.	<input type="text"/>
12.143	200mm	Pack 50 Uni.	<input type="text"/>
12.144	300mm	Pack 50 Uni.	<input type="text"/>
12.145	400mm	Pack 50 Uni.	<input type="text"/>
12.146	500mm	Pack 50 Uni.	<input type="text"/>
12.147	600mm	Pack 50 Uni.	<input type="text"/>
12.148	750mm	Pack 50 Uni.	<input type="text"/>
12.149	900mm	Pack 50 Uni.	<input type="text"/>
12.150	1000mm	Pack 50 Uni.	<input type="text"/>

## Nylon Line

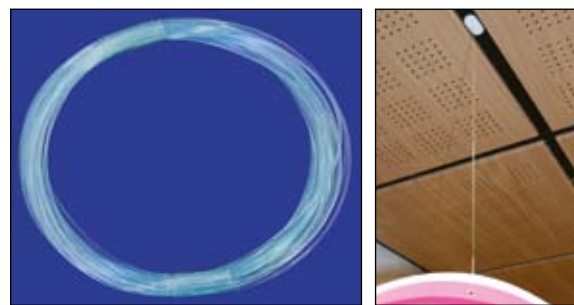

Blue nylon line, wire diameter : 0.5mm. 5 meter per roll.

**Material:** Nylon.

12.373	5m	Pack 50 Uni.	<input type="text"/>
--------	----	--------------	----------------------



## "S" Hook

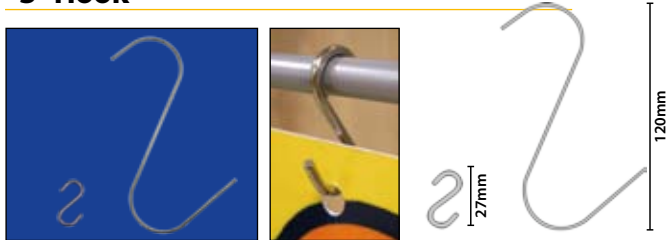

"S" hook. Bright metal plated.

**Material:** Steel.

12.152 27mm - Ø1,1mm Pack 100 Uni.

12.154 120mm - Ø2mm Pack 100 Uni.

## Metal Ring

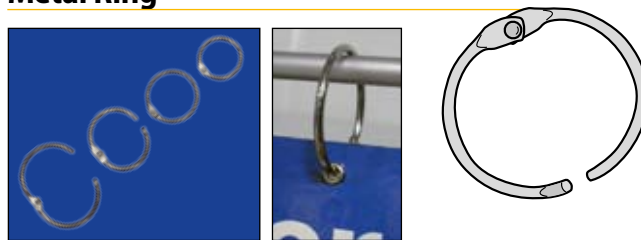

Metal locking ring. Bright metal finish.

**Material:** Steel.

12.160 Ø 19mm Pack 100 Uni.

12.161 Ø 25mm Pack 100 Uni.

12.162 Ø 32mm Pack 100 Uni.

12.163 Ø 38mm Pack 100 Uni.

## Oval Pop-Ring



White plastic snap together connecting ring.

**Material:** Plastic.

12.380 50mm Pack 100 Uni.

12.158 20mm Pack 200 Uni.

## Hanging Clip



Hanging clip.

**Material:** Steel.

12.164 10x27mm Pack 100 Uni.

## Round Pop-Ring

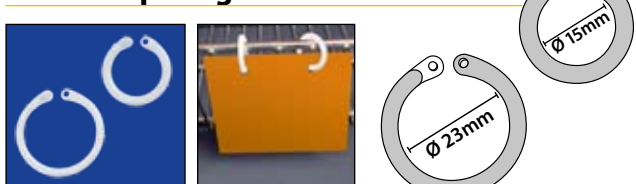

White plastic ring for connecting sets of signs. 15 or 23mm diam.

**Material:** Plastic.

12.159 Ø 15mm Pack 500 Uni.

12.304 Ø 23mm Pack 100 Uni.

## Hanging Clip

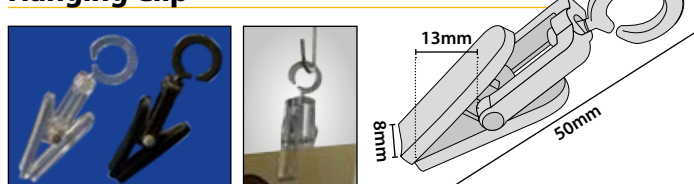

Plastic hanging clip.

**Material:** Plastic.

12.374  clear 50mm Pack 100 Uni.

12.375  50mm Pack 100 Uni.

## Mini Magnetic Hook Hanger



Mini magnetic hook hanger.

**Material:** Plastic.

12.386 Ø 15mm Pack 50 Uni.

## Mini Magnetic Ring Hanger



Mini magnetic ring hanger.

**Material:** Plastic.

12.385 Ø 15mm Pack 50 Uni.

## Magnet Square

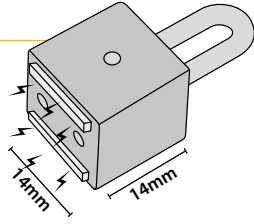
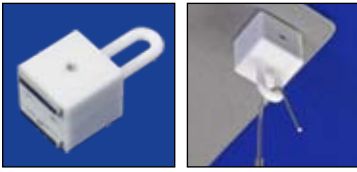

Magnet square ceiling hook.

**Material:** Plastic.

**12.165** 14x14mm Pack 50 Uni.

## Round Magnetic

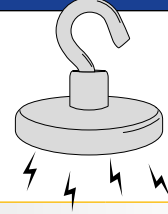

Magnetic ceiling hook.

**Material:** Steel.

**12.167** Ø 25mm Pack 50 Uni.

**12.347** Ø 32mm Pack 50 Uni.

**12.348** Ø 40mm Pack 50 Uni.

**12.349** Ø 50mm Pack 50 Uni.

**12.350** Ø 63mm Pack 50 Uni.

## Magnet Rectangle

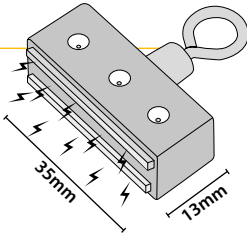

Magnet rectangle ceiling hook.

**Material:** Steel.

**12.166** 35x13mm Pack 50 Uni.

## Pegboard

Made of heavy-duty plastic will be good for displays, furniture, PLV, etc. Simple to use and provides large visual impact.

### Double Prong Pegboard

Double prong pegboard. Three different sizes are available.

**Material:** Plastic.

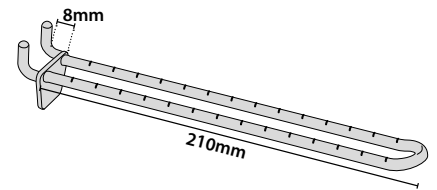
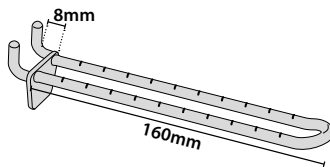
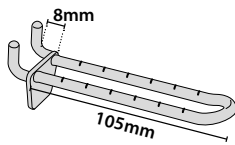

**12.252** 105mm Pack 50 Uni.

**12.253** 160mm Pack 50 Uni.

**12.254** 210mm Pack 50 Uni.

### Long Single Prong Pegboard

Long single prong pegboard. Three different sizes are available.

**Material:** Plastic.

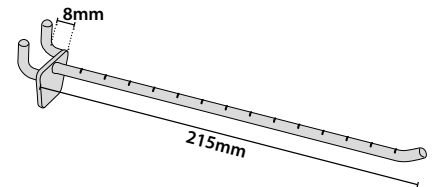
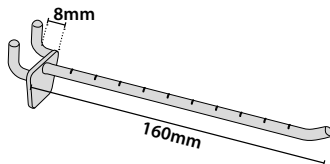
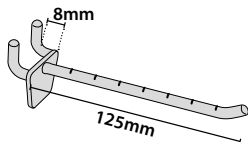

**12.255** 125mm Pack 50 Uni.

**12.256** 160mm Pack 50 Uni.

**12.257** 215mm Pack 50 Uni.

## Double Prong Quick-Stick

Double prong quick-stick. Three different sizes are available.

**Material:** Plastic.

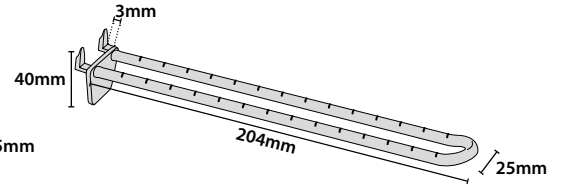
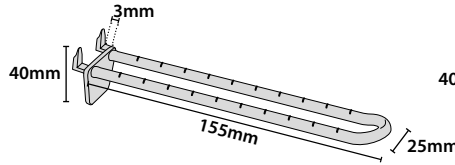
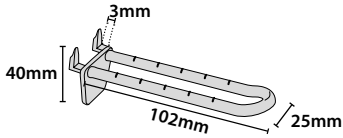

12.258 102mm Pack 50 Uni.

12.259 155mm Pack 50 Uni.

12.260 204mm Pack 50 Uni.

## Single Prong Quick-Stick

Single prong quick-stick. Available in 6 different sizes.

**Material:** Plastic.

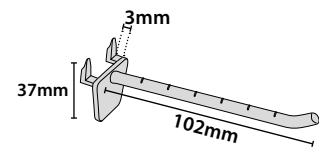
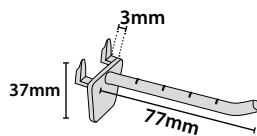
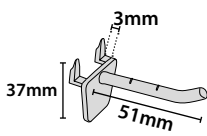

12.261 51mm Pack 50 Uni.

12.262 77mm Pack 50 Uni.

12.263 102mm Pack 50 Uni.

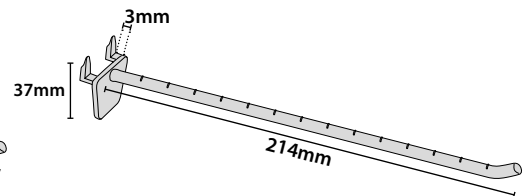
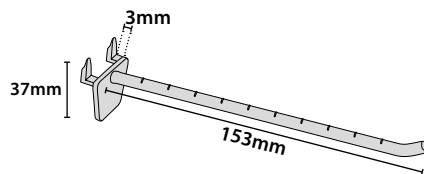
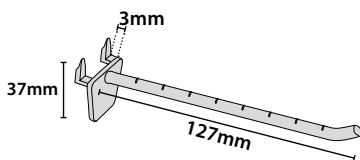

12.264 127mm Pack 50 Uni.

12.265 153mm Pack 50 Uni.

12.266 214mm Pack 50 Uni.

## Insert Pegboard Flat

Insert pegboard flat. Three different sizes are available.

**Material:** Plastic.

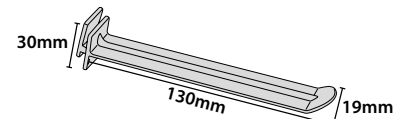
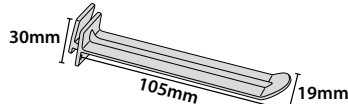
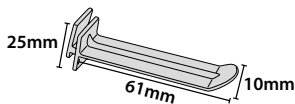

12.269 61mm Pack 50 Uni.

12.270 105mm Pack 50 Uni.

12.271 130mm Pack 50 Uni.

## Insert Pegboard

Insert pegboard. 5 diferents sizes are available.

**Material:** Plastic.

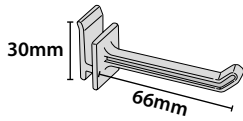

12.272 66mm Pack 50 Uni.

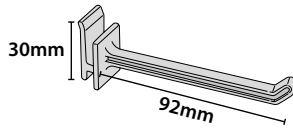

12.273 92mm Pack 50 Uni.

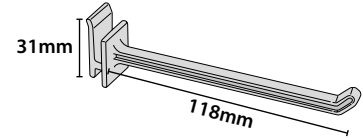

12.274 118mm Pack 50 Uni.

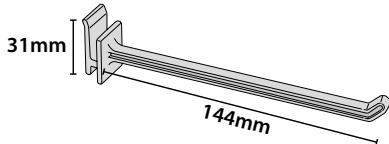

12.275 144mm Pack 50 Uni.

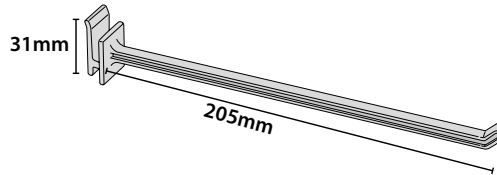

12.276 205mm Pack 50 Uni.

## Double Hook

Insert pegboard double hook with price holder.

**Material:** Plastic.

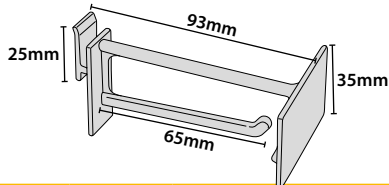

12.112 65mm Pack 50 Uni.

## Insert Pegboard

Insert pegboard. Available in 2 diferents sizes.

**Material:** Plastic.

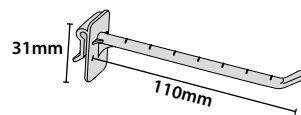

12.267 110mm Pack 50 Uni.

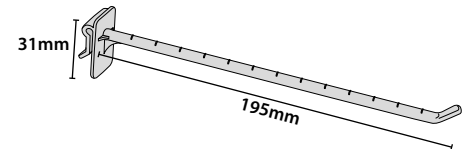

12.268 195mm Pack 50 Uni.

## Pegboard for Slat Wall

Pegboard for slat wall. Lenght 126mm.

**Material:** Plastic.

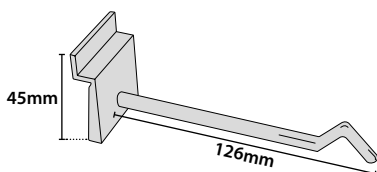

12.111 126mm Pack 50 Uni.

## Coupon Hook

White plastic hook for scanner rails. Size 54x38mm.

**Material:** Plastic.

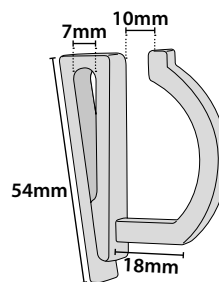

12.279 54x38mm Pack 50 Uni.

## Coupon Hook

White plastic hook for scanner rails. Size 30x24mm.

**Material:** Plastic.

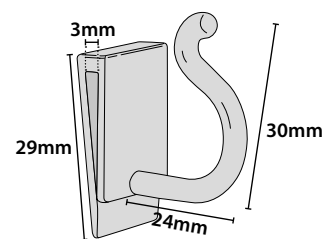

12.074 30x24mm Pack 50 Uni.

## Hang Tab

Hangtab are quick and easy to use for merchandising products.

**Material:** Plastic.

### Hang Tab Euroslot

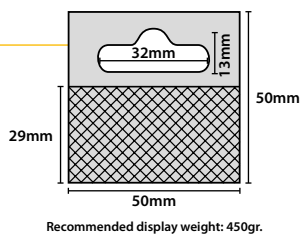

12.357 Pack 100 Uni.

### Hang Tab Standard

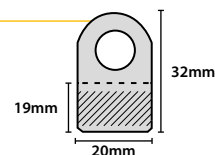

12.358 Pack 100 Uni.

### Hang Tab Flexi

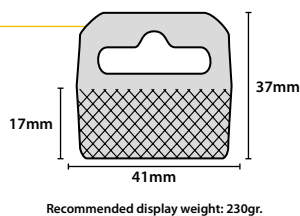

12.359 Pack 100 Uni.

### Hang Tab Hooks

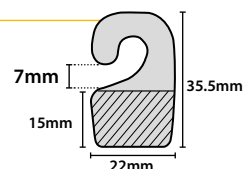

12.360 Pack 100 Uni.

### Hang Tab Easy

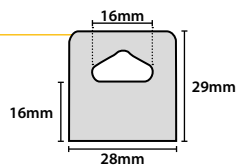

12.361 Pack 100 Uni.

### Hang Tab Nova

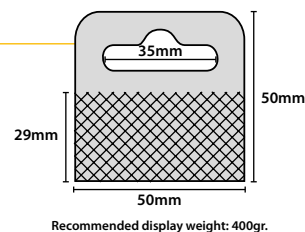

12.362 Pack 100 Uni.

### Hang Tab Folding

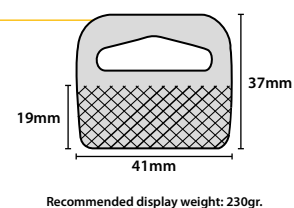

12.363 Pack 100 Uni.

### Hang Tab Quick

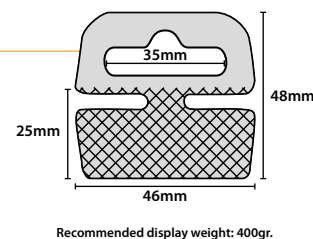

12.364 Pack 100 Uni.

### Hang Tab Use

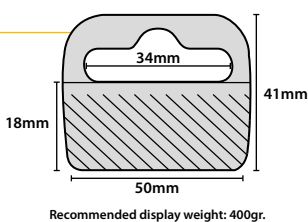

12.365 Pack 100 Uni.

### Hang Tab Repair

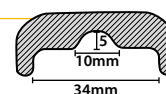

12.366 Pack 100 Uni.

## Power Wing

Power wing. White PVC clip fastens corrugated displays to card board, wire, glass, etc. Available in 2 different sizes.

**Material:** Plastic.

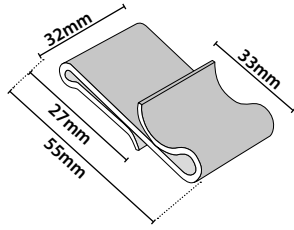

**12.277** 55x32mm Pack 50 Uni.

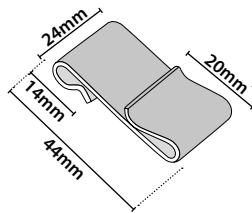

**12.278** 44x24mm Pack 50 Uni.

## Stock Limiter

Stock limiter for pegboard hooks.

**Material:** Plastic.



**12.280** Ø 26mm Pack 50 Uni.

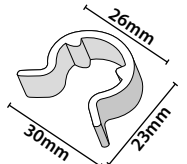

**12.281** Double 26mm Pack 50 Uni.

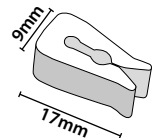

**12.282** Simple 17mm Pack 50 Uni.

## Corrugated Display

### Snap Rivet

Natural nylon different diameters snap rivet. Includes nuts.

**Material:** Plastic.

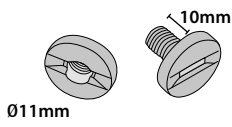

**12.283** 11mm Pack 50 Uni.

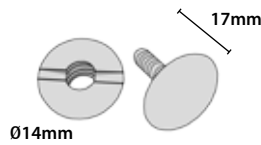

**12.284** 14mm Pack 50 Uni.

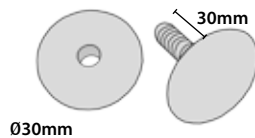
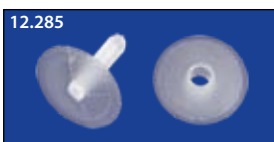

**12.285** 30mm Pack 50 Uni.

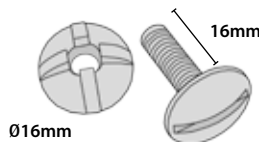

**12.367** 16mm Pack 50 Uni.

## Plastic Display Caster

Plastic display caster. Easy and quick to use.

**Material:** Plastic.

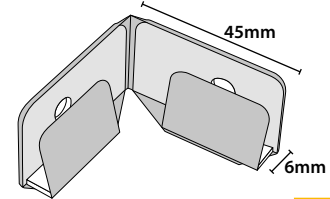

**12.286** Simple Pack 50 Uni.

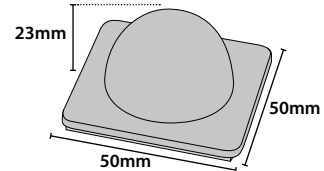

**12.287** Adhesive Pack 50 Uni.

## Suction Cup

Suction cup. Fast and easy to use on glass or flat surface.

**Material:** Plastic.

## Suction Cup with Nipple



Suction cup sign holder. Suction cup with nipple head allows you to hang signs with holes or grommets. For temporary use on any smooth, flat surface.

**Material:** Plastic.

12.168    Ø 30mm    Pack 100 Uni.

## Suction Cup Metal Hook

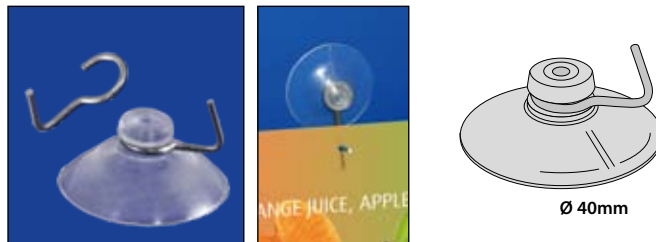

Suction cup sign holder with metal hook. Suction cup for one step hanging. For temporary use on any smooth, flat surface.

**Material:** Plastic.

12.169    Ø 40mm    Pack 100 Uni.

## Double Suction Cup with Plastic Hook



Double suction cup with plastic hook. For extra strong adhesion, with a 3 position hook (left, right, ahead).

**Material:** Plastic.

12.172    Ø 45mm    Pack 100 Uni.

## Suction Cup Thumbback Plastic

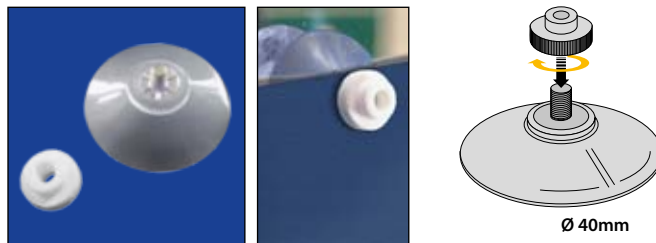

Suction cup with screw. Diameter: 40 mm.

**Material:** Plastic.

12.388    Ø 40mm    Pack 100 Uni.

## Suction Cup Thumbback Plastic

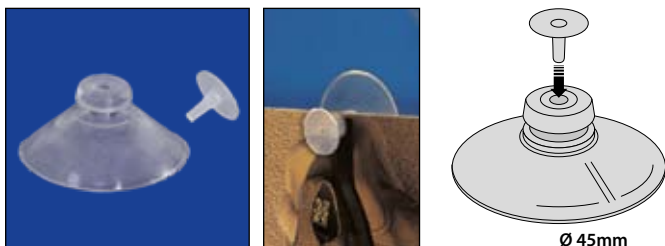

Suction cup sign holder with plastic thumbback. Suction cup with plastic thumbback to keep signs in place. For temporary use on any smooth, flat surface.

**Material:** Plastic.

12.170    Ø 45mm    Pack 100 Uni.

## Double Suction Cup Thumbback Plastic

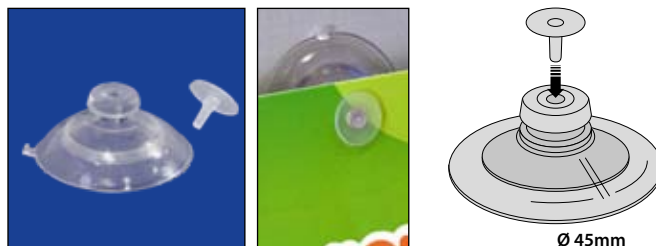

Double suction cup holder with plastic thumbback. For extra strong adhesion with hook.

**Material:** Plastic.

12.171    Ø 45mm    Pack 100 Uni.

## Grip Strip

### Grip Strip with Adhesive



Grip strip. Transparent PVC supergrip with adhesive.

**Material:** Plastic.

12.187	25mm	Pack 200 Uni.	
12.188	38mm	Pack 200 Uni.	
12.189	76mm	Pack 100 Uni.	

### Hinged Data Grip

Hinged data grip.

**Material:** Plastic.



12.192	20x40mm	Pack 100 Uni.	
--------	---------	---------------	--

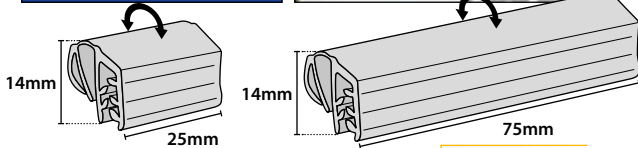

12.193	25mm	Pack 200 Uni.	
12.194	75mm	Pack 100 Uni.	

### Double Gripper



Double gripper.

**Material:** Plastic.

12.369	25mm	Pack 100 Uni.	
12.370	38mm	Pack 100 Uni.	

### Hinged Flip Strip with Adhesive

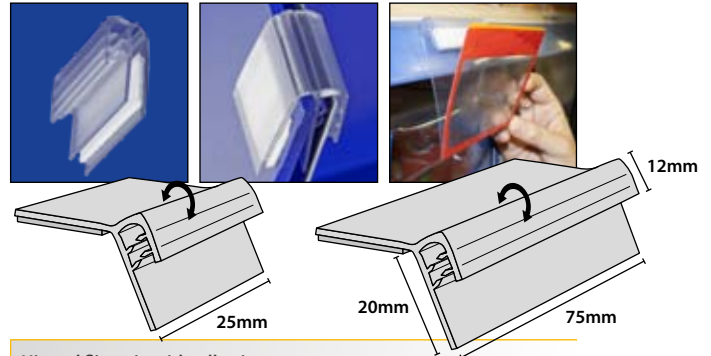

Hinged flip strip with adhesive.

**Material:** Plastic.

12.190	25mm	Pack 100 Uni.	
12.191	75mm	Pack 100 Uni.	

### Adjustable Angle Data Clip



Adjustable angle data clip.

**Material:** Plastic.

12.233	28x29mm	Pack 25 Uni.	
--------	---------	--------------	--

### Shelf Edge Poster

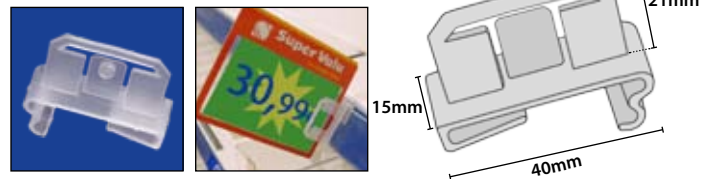

Shelf edge poster bracket for data strip.

**Material:** Plastic.

12.071	40x15mm	Pack 50 Uni.	
--------	---------	--------------	--

### Data Clip

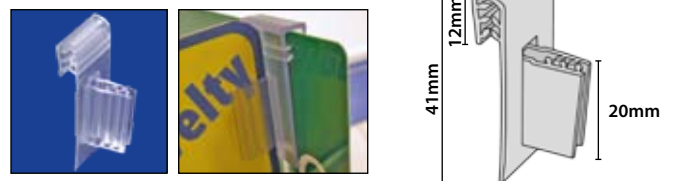

Data clip.

**Material:** Plastic.

12.195	20mm	Pack 100 Uni.	
--------	------	---------------	--



## Gripper

Grip.

**Material:** Plastic.

## "H" Gripper

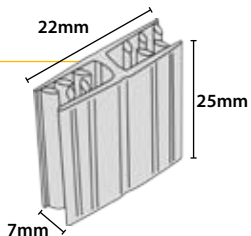
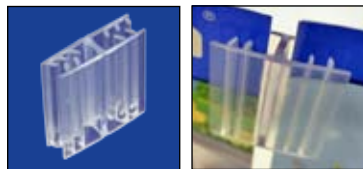

12.197 22x25mm Pack 100 Uni.

## 2 - Way Gripper (60°)

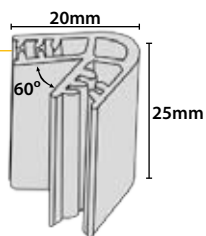

12.371 20x25mm Pack 50 Uni.

## Wire Basket Sign Holder

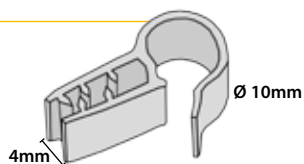

Wire basket sign holder.

**Material:** Plastic.

12.196 15mm Pack 200 Uni.

## Suction Cup Sign Holder

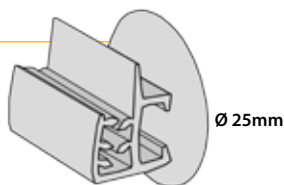

Suction cup sign holder.

**Material:** Plastic.

12.200 Ø 25mm Pack 50 Uni.

## 2 - Way Gripper (90°)

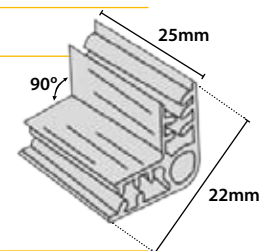

12.198 22x25mm Pack 50 Uni.

## 3 - Way Gripper

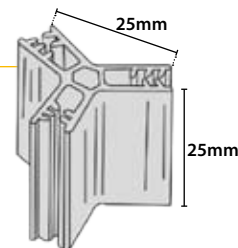

12.372 25x25mm Pack 50 Uni.

## 4 - Way Gripper

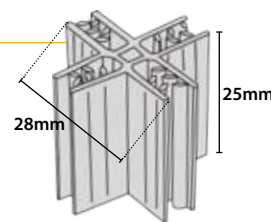

12.199 28x25mm Pack 50 Uni.

## Suction Cup Sign Holder

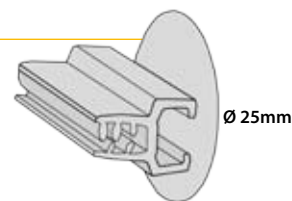

Suction cup sign holder.

**Material:** Plastic.

12.201 Ø 25mm Pack 50 Uni.

## Sign Gripper

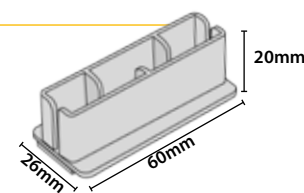
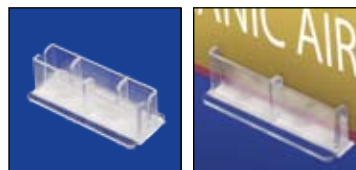

Sign Gripper. Clear plastic. 60 mm long, accepts material up to 2 mm.

**Material:** Plastic.

12.339 60x20mm Pack 25 Uni.

## Clear Supergrip Card Holder

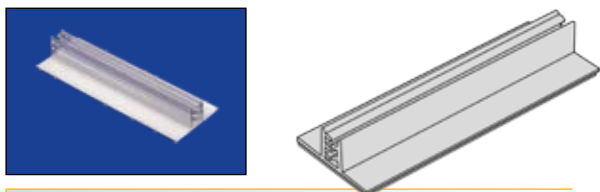

Clear supergrip card holder. Different sizes are available.

**Material:** Plastic.

12.183	12x25mm	Pack 100 Uni.	<input type="text"/>
12.184	12x75mm	Pack 50 Uni.	<input type="text"/>
12.185	25x25mm	Pack 100 Uni.	<input type="text"/>
12.186	25x75mm	Pack 50 Uni.	<input type="text"/>

## Master Grip with Adhesive

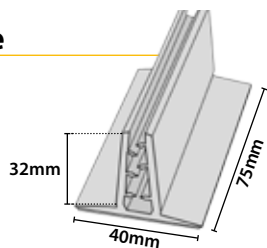

Master grip hinge sign holder with adhesive.

**Material:** Plastic.

12.346	40x75mm	Pack 50 Uni.	<input type="text"/>
--------	---------	--------------	----------------------

## Single Spring

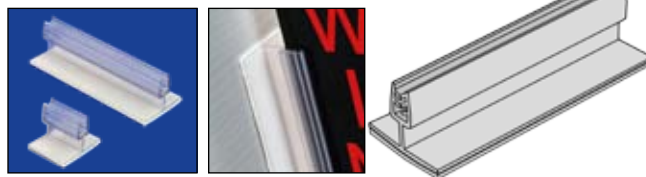

Single spring hinge sign holder.

**Material:** Plastic.

12.382	25mm	Pack 100 Uni.	<input type="text"/>
12.202	76mm	Pack 100 Uni.	<input type="text"/>

## Super Grip with Adhesive

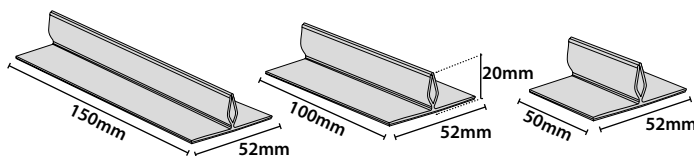
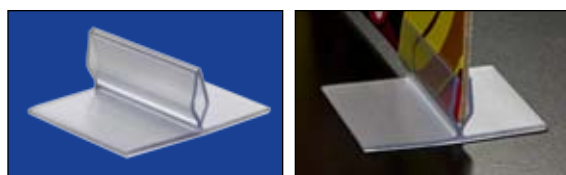

Super grip hinge sign holder with adhesive.

**Material:** Plastic.

12.378	50mm	Pack 50 Uni.	<input type="text"/>
12.379	100mm	Pack 50 Uni.	<input type="text"/>
12.383	150mm	Pack 50 Uni.	<input type="text"/>

## Wobblers

Wobblers exhibition system is ideal for presentations and showrooms. It's simple to use and provides large visual impact.

### Clear Wobbler

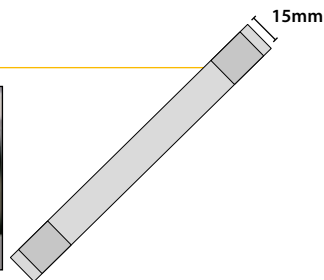

Wobbler with 2 adhesive pads.

**Material:** Plastic.

12.203	15x150mm	Pack 200 Uni.	<input type="text"/>
12.225	15x200mm	Pack 200 Uni.	<input type="text"/>

### Aluminium Wobbler

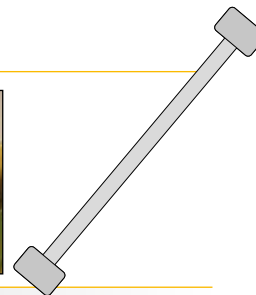

Punched aluminium 75/150mm long with 2 adhesive pads. Twist to any position.

**Material:** Aluminium.

12.204	75mm	Pack 100 Uni.	<input type="text"/>
12.205	150mm	Pack 50 Uni.	<input type="text"/>

## Spring Wobbler



A low cost spring wobbler with 20x20mm and 40mm long. White plastic adhesive.

**Material:** Plastic.

12.206      40mm  
20x20mm      Pack 100 Uni.

## Aluminium Wobbler

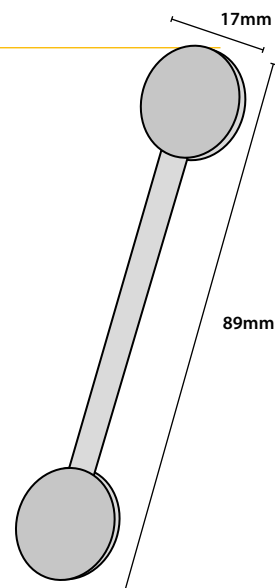

Punched aluminium 89mm long with 2 adhesive pads. Twist to any position.

**Material:** Aluminium.

12.294      89mm      Pack 50 Uni.

## Wobbler "Spacer"



Wobbler "spacer". Produces a space between 2 signs.

**Material:** Plastic.

12.207      13x26x17mm      Pack 100 Uni.

## Ticket Holder

### Menu Holder

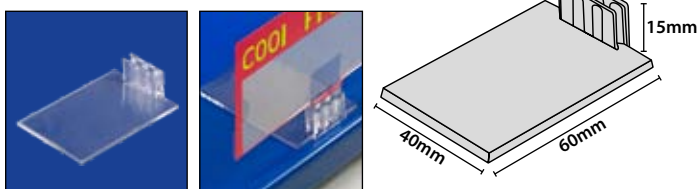

Menu holder. Clear plastic.

**Material:** Plastic.

12.208      40x60mm      Pack 100 Uni.

### Pin Ticket



Ticket holder pin 60/80mm.

**Material:** Plastic.

12.209      60mm      Pack 100 Uni.

12.210      80mm      Pack 100 Uni.

## Hanging Price Holder



Hanging price holder. With clips for attaching to wire baskets or wire shelving. Anti-reflective PVC.

**Material:** Plastic.

12.295      Graphic  
100x40mm      Pack 50 Uni.

## Clip Shoe

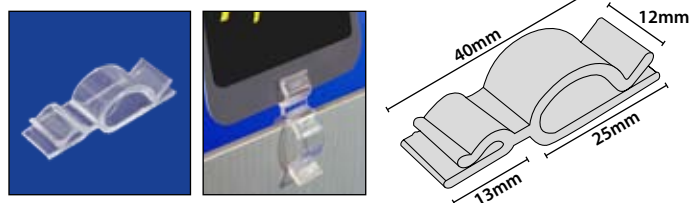

Clip on sign holder. Clear plastic clip 25mm wide.

**Material:** Plastic.

12.211      25mm      Pack 100 Uni.

## Sign Supports and Flags

This simple system is suitable for exhibition and point of sales.

### Flag Holder

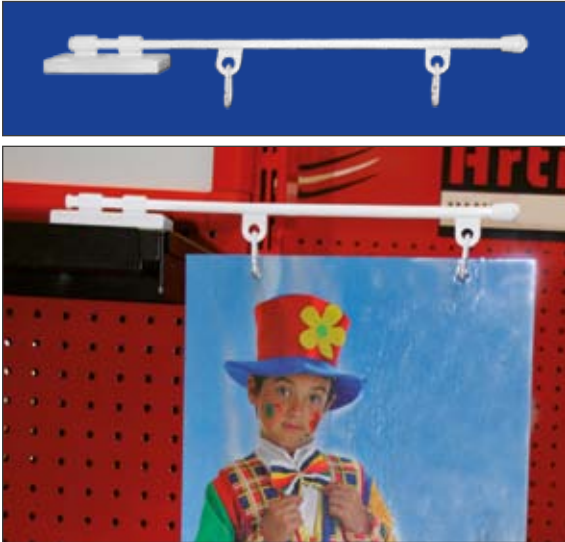

Flag plastic holder with magnet and rings. Length 300mm. Colour: white.

**Material:** Plastic.

**12.173**    **310mm**    **Pack 10 Uni.**

### Flag Holder

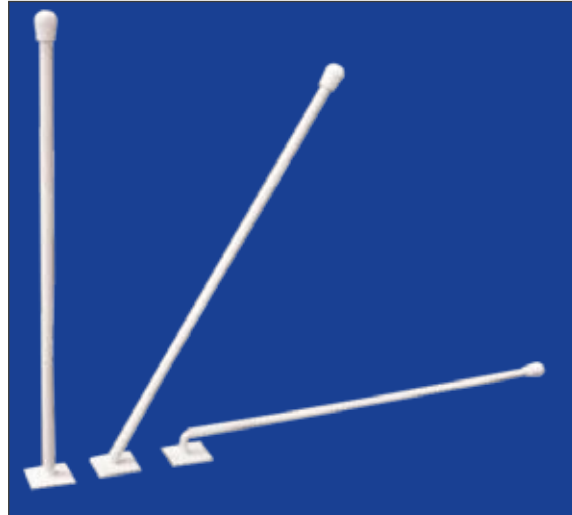

Flag holder. For 300mm long, different angles with foam adhesive. Colour: white.

**Material:** Plastic.

**12.174**    **45°**    **Pack 50 Uni.**

**12.175**    **90°**    **Pack 50 Uni.**

**12.176**    **180°**    **Pack 50 Uni.**

### Flag Holder with Adhesive and Ring

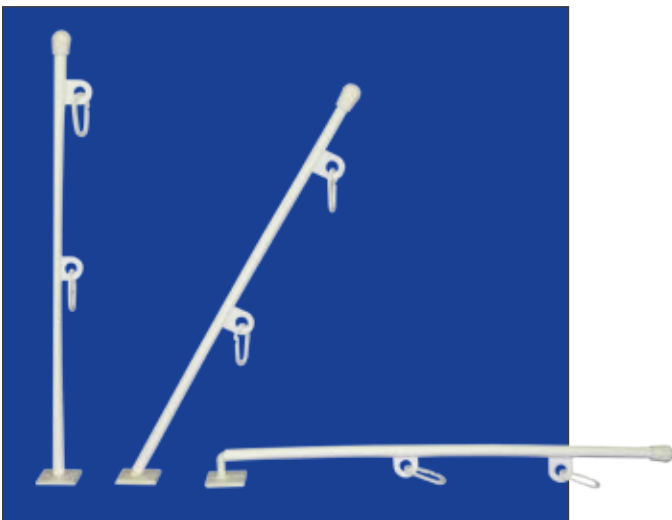

Flag holder with adhesive and rings. For 300mm long, different angles with foam adhesive and rings. Colour: white.

**Material:** Plastic.

**12.177**    **45°**    **Pack 50 Uni.**

**12.178**    **90°**    **Pack 50 Uni.**

**12.179**    **180°**    **Pack 50 Uni.**

### Banner Holder with Two Adhesive

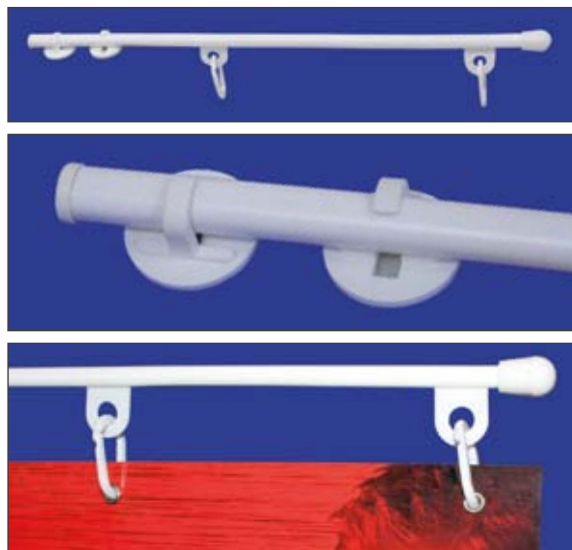

Banner holder with two adhesive. For 300mm long. Colour: White.

**Material:** Plastic.

**12.180**    **300mm**    **Pack 20 Uni.**

## Sign Clip "L" Magnetic

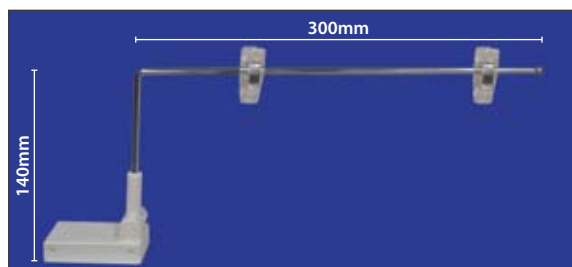

Sign Clip. With display arm and magnetic base. Angle adjustable to 180°. Colour: white.

**Material:** Plastic, steel.

**12.302** Pack 10 Uni.

## Sign Clip "L" Magnetic

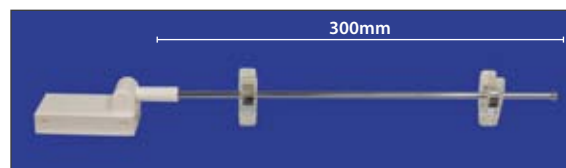

Sign Clip. With magnetic base, angle adjustable up to 180°. Colour: white.

**Material:** Plastic, steel.

**12.303** Pack 10 Uni.

## Sign Clip "L" Magnetic

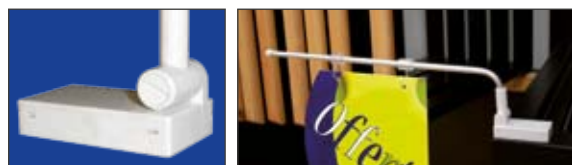
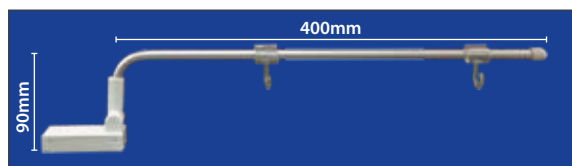

Sign Clip. With display arm and magnetic base. Angle adjustable to 180°. Colour: white.

**Material:** Plastic, aluminium.

**12.381** Pack 10 Uni.

## Magnetic Clip



Magnetic clip for sign support.

**Material:** Plastic.

**12.078** Pack 50 Uni.

## Sign Support and Flags

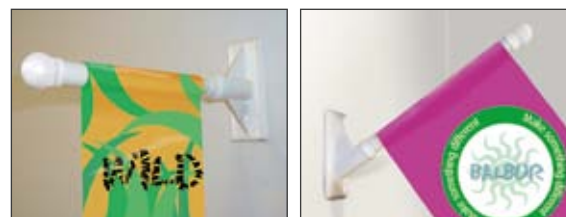
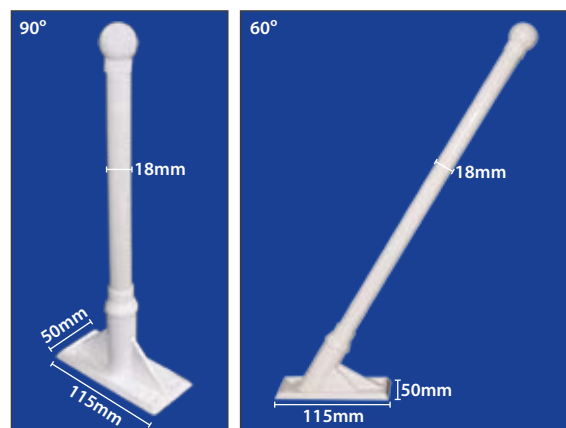

Flag set. Consist of: flag pole, ball cap, shelf adhesive wall bracket with holes. Available in 2 angles and 3 different sizes.

**Material:** Plastic.

**12.297** 60° 280mm Pack 20 Uni.

**12.299** 60° 400mm Pack 20 Uni.

**12.289** 60° 600mm Pack 20 Uni.

**12.298** 90° 280mm Pack 20 Uni.

**12.288** 90° 400mm Pack 20 Uni.

**12.290** 90° 600mm Pack 20 Uni.

## Razz Thin Poster Channel

Razz thin poster channel. Transparent channel for thinner material. Use with items numbers 12.220 and 12.221.

**Material:** Plastic.

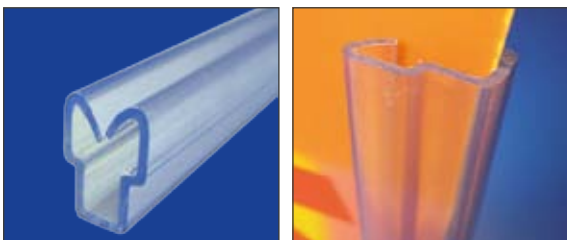

**12.218**    **300mm**    **Pack 20 Uni.**

**12.219**    **460mm**    **Pack 20 Uni.**

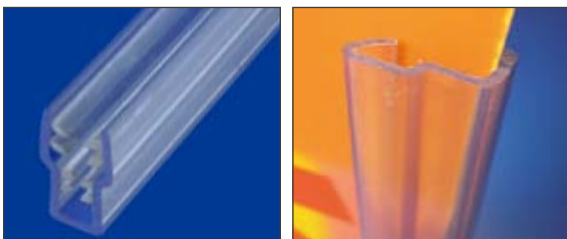

**12.216**    **300mm**    **Pack 20 Uni.**

**12.217**    **460mm**    **Pack 20 Uni.**

## Coupon Holder

Coupon holder made of PVC fitted out with adhesive or supergrip 75mm wide. Capacity 8mm: 75 maco sat (115grs). Capacity 18mm: 125 coupons maco sat (115grs).

**Material:** Plastic.



Coupon holder made of PVC fitted out with adhesive.

**12.212**    **8mm**    **Pack 20 Uni.**

**12.214**    **18mm**    **Pack 20 Uni.**

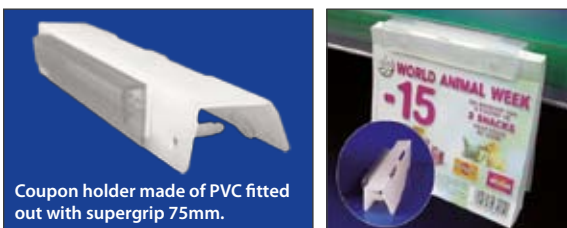

Coupon holder made of PVC fitted out with supergrip 75mm.

**12.213**    **8mm**    **Pack 20 Uni.**

**12.215**    **18mm**    **Pack 20 Uni.**

## L-Base Magnetic

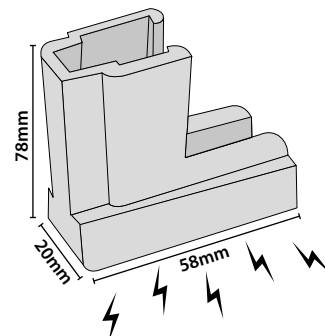

L-base magnetic. Magnetic stand black or white.

**Material:** Plastic.

**12.220**     **Pack 20 Uni.**

**12.221**     **Pack 20 Uni.**

## "Spiral"



Adhesive



"Spiral" shelf edge poster bracket.

**Material:** Plastic.

**12.232**    **30x70mm**    **Pack 20 Uni.**

## Shelf Edge Poster Brackets



Shelf edge poster brackets. Use in perforated shelves with holes to 54mm away. Metallic clip are included.

**Material:** Plastic.

**12.222**    **85mm**    **Pack 50 Uni.**

## Shelf Edge Poster Brackets 3 Positions



Fixed clear bracket 145mm. Adjustable clear, bracket with 3 positions. Metallic clips for shelf edge fixing.

**Material:** Plastic.

**12.223**    **145mm**    **Pack 50 Uni.**

## Mobile Kits

Mobile kit. Natural polypropylene formers for creating three or four faced mobiles.

### Mobile Kit - Trimaxi

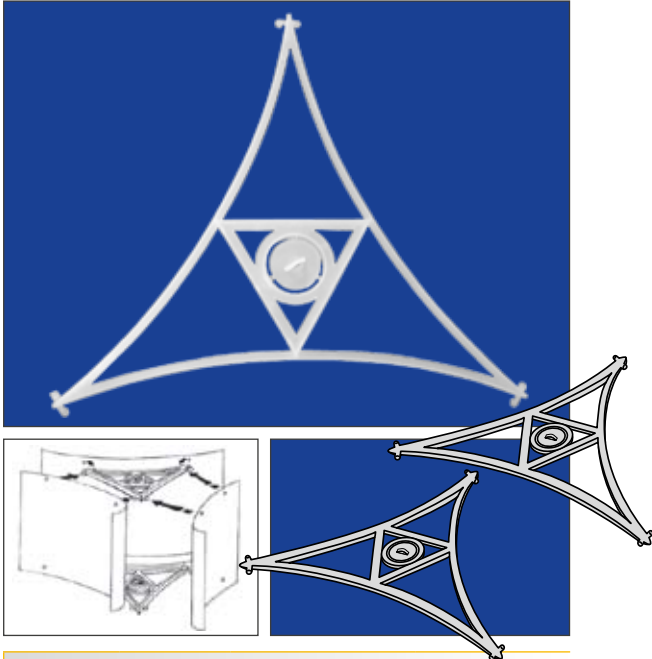

Distance between holes: 317mm. Holes Ø 5mm. Graphic size: 400mm to 750mm (minimun 330mm).

**Material:** Plastic.

12.234

Pack 2 Uni.

### Mobile Kit - Trimedium



Distance between holes: 160mm. Holes Ø 5mm. Graphic size: A4 to 400mm (minimun 200mm).

**Material:** Plastic.

12.235

Pack 2 Uni.

### Mobile Kit - Quadrama

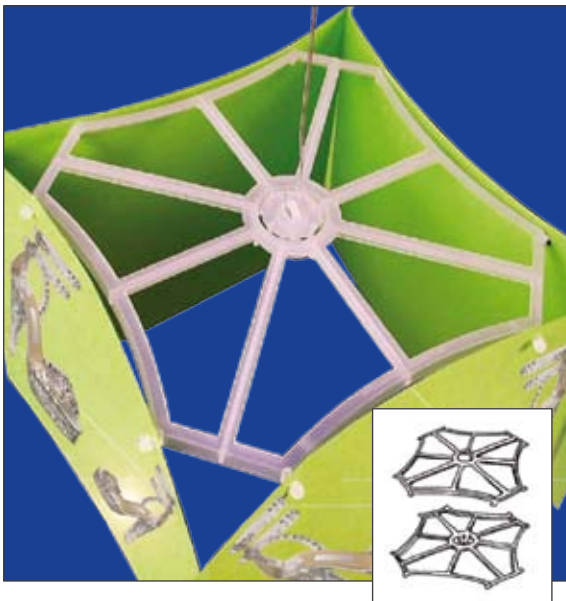

Distance between holes: 160mm. Holes Ø 5mm. Graphic size: A4 to 400mm (minimun 200mm).

**Material:** Plastic.

12.236

Pack 2 Uni.

### Mobile Kit - Minirama



Distance between holes: 105mm. Holes Ø 5mm. Graphic size: A4 to 400mm (minimun 200mm).

**Material:** Plastic.

12.067

Pack 2 Uni.



## Badge Pin

Clip badge (safety) pin.

**Material:** Plastic.



**12.101** 40x10mm Pack 50 Uni.



**12.102** 19x19mm Pack 50 Uni.

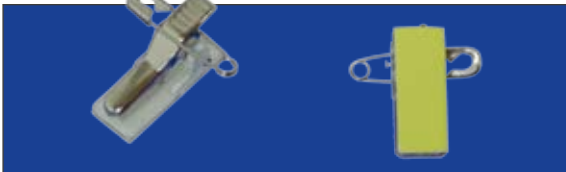

**12.100** 32x12mm Pack 50 Uni.

## Metal Clamp



**Material:** Metal, plastic parts.

**12.442** 24x12mm Pack 50 Uni.

**12.443** 25x15mm Pack 50 Uni.

## Hanger Magnetic / Pin Clamp

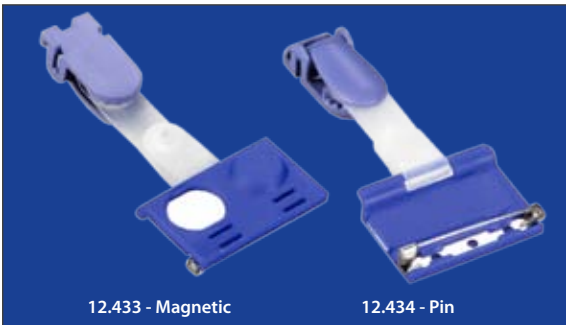

**Material:** Plastic.

**12.433** Pack 50 Uni.

**12.434** Pack 50 Uni.

## Pin Plastic Clamp

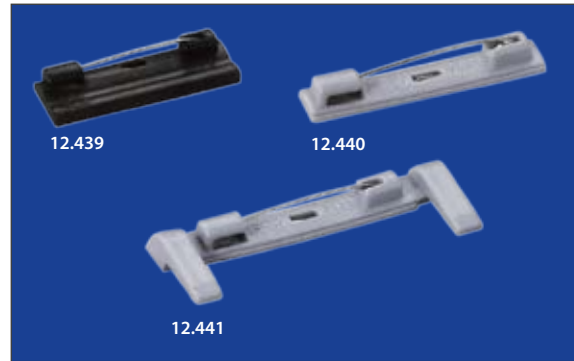

**Material:** Plastic.

**12.439**  Pack 50 Uni.

**12.440**  Pack 50 Uni.

**12.441**  Pack 50 Uni.

## Hung Clamp

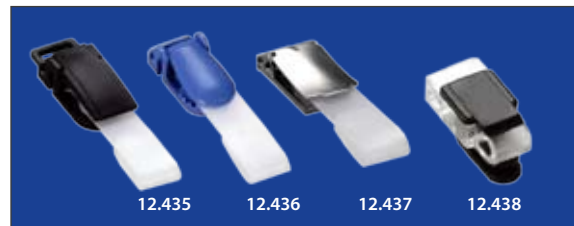

**12.435** Pack 50 Uni.

**12.436** Pack 50 Uni.

**12.437** Pack 50 Uni.

**12.438** Pack 50 Uni.

## Badge Pin



Badge clip. With metal clip. Pack: 50 pieces.

**Material:** Plastic.

**12.110** Pack 50 Uni.





## Name Badge

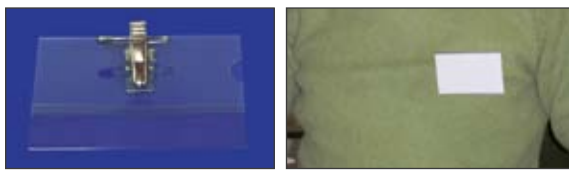

Card insert left blank for own labelling. Interchangeable. Clip with metal backing and pin. Colour: transparent.

**Material:** Plastic.

12.105 90x55mm Pack 50 Uni.

## ABS Magnet Name Badges



12.393

12.392

**Material:** Plastic.

12.392  75x32mm Pack 50 Uni.

12.393  75x32mm Pack 50 Uni.

## Acrylic Pin Name Badges

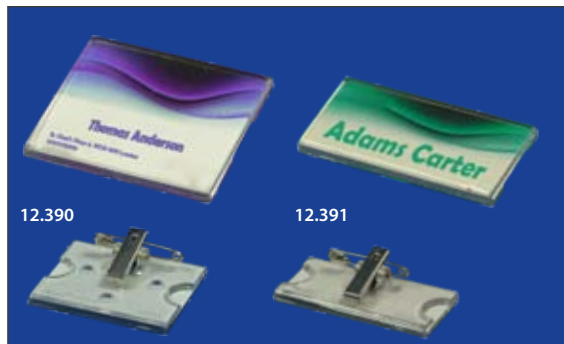

12.390

12.391

**Material:** Plastic.

12.390 50x40mm Pack 50 Uni.

12.391 60x25mm Pack 50 Uni.

## ABS Pin Name Badges

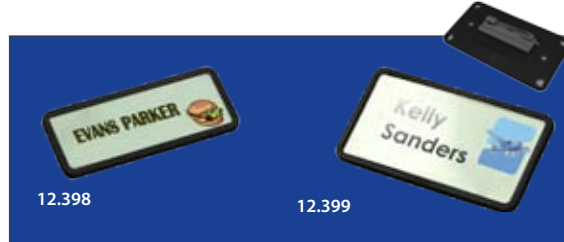

12.398

12.399

**Material:** Plastic.

12.398  75x25mm Pack 50 Uni.

12.399  75x35mm Pack 50 Uni.

## ABS Pin Name Badges



12.394

12.395

**Material:** Plastic.

12.394  75x32mm Pack 50 Uni.

12.395  75x32mm Pack 50 Uni.

## ABS Magnet Name Badges

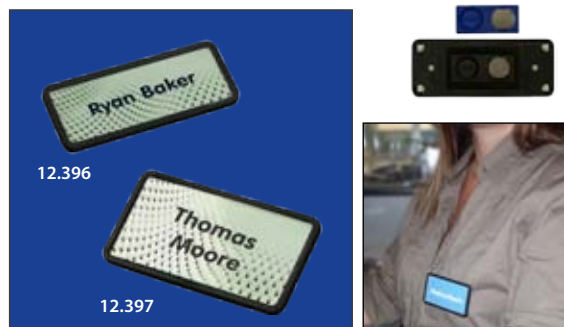

12.396

12.397

**Material:** Plastic.

12.396  75x25mm Pack 50 Uni.

12.397  75x35mm Pack 50 Uni.



## Soft PVC Card Holders

Made to measure covers and bags to hang up, send and protect your documents.

**Material:** PVC.



12.415

12.414 49x89mm Pack 50 Uni.

12.415 89x49mm Pack 50 Uni.

\* Suspension rope not includes.



12.416

12.416 89x49mm Pack 50 Uni.

12.417 49x89mm Pack 50 Uni.

\* Suspension rope not includes.



12.428 89x49mm Pack 50 Uni.

\* Suspension rope not includes.



12.421 89x49mm Pack 50 Uni.

\* Suspension rope not includes.



12.419

12.418 70x99mm Pack 50 Uni.

12.419 99x70mm Pack 50 Uni.

\* Suspension rope not includes.



12.107 95x55mm Pack 50 Uni.

12.108 105x80mm Pack 50 Uni.

12.109 150x105mm Pack 50 Uni.

\* Suspension rope not includes.



**Material:** PVC.

12.423 95x75mm Pack 50 Uni.

\* Suspension rope not includes.



## Depolished PVC Card Holders



12.426

12.427

**Material:** PVC.

12.426  49x89mm Pack 50 Uni.

12.427  89x49mm Pack 50 Uni.

\* Suspension rope not includes.

## Card Holder



Opening on the short side, landscape. Price excludes clip.

**Material:** Plastic.

12.106 90x55mm Pack 50 Uni.

## Acrylic ID/IC Card Case



12.411

12.412

**Material:** Plastic.

12.411  54x86mm Pack 50 Uni.

12.412  54x86mm Pack 50 Uni.

## Hard PVC Card Holders



**Material:** PVC.

12.425 89x49mm Pack 50 Uni.

\* Suspension rope not includes.

## Acrylic ID/IC Card Case



**Material:** Plastic.

12.413 54x86mm Pack 50 Uni.

## Vertical/Horizontal ABS Card Holder



**Material:** ABS.

12.422 89x49mm Pack 50 Uni.

## "Yo Yo" for Badges



Plastic casing available in grey and purple. With reinforced clip.

**Material:** Plastic.

12.103	<input type="checkbox"/>	Pack 50 Uni.	<input type="text"/>
12.104	<input type="checkbox"/>	Pack 50 Uni.	<input type="text"/>



## Multifunctional Dual Colour Suspension Rope



**Material:** Textile.

12.431	450x11mm	Pack 50 Uni.	<input type="text"/>
--------	----------	--------------	----------------------

## Plastic Button Dual Colour Suspension Rope

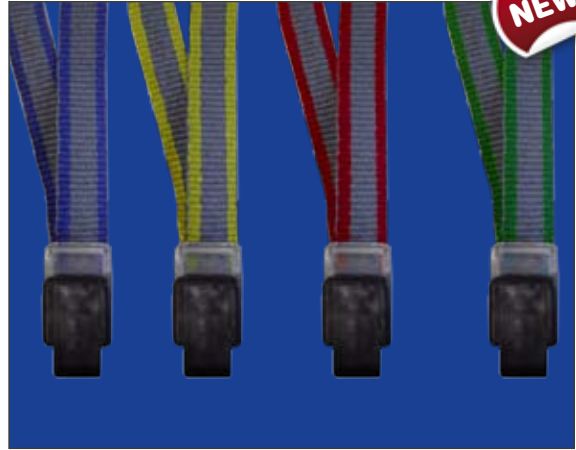

**Material:** Textile.

12.432	450x11mm	Pack 50 Uni.	<input type="text"/>
--------	----------	--------------	----------------------

## Metal Clip Suspension Rope



**Material:** Textile.

12.429	450x11mm	Pack 50 Uni.	<input type="text"/>
--------	----------	--------------	----------------------



# 10

Directory	
P1	Reception
P2	Administration
P3	Production
P4	Management



signs

## Sign System "Louvre"

Glass system signs. Includes two glasses 3mm thickness. Includes:

- Aluminium profile (1 or 2).
- Two 3mm thickness glasses.
- Plastic endcaps.
- Screw key.

\* Indoor use: shops, office, etc.

\* Easy and quick to assemble.

**Material:** Aluminium, glass, plastic parts.



Install explain:

1. Firstly, fasten the groove with screws to the place where you want to set.
2. Secondly, clamp the glass into the aluminium alloy groove.
3. Fix and fasten the two grooves together with screws.
4. Stick the two overs into both end.

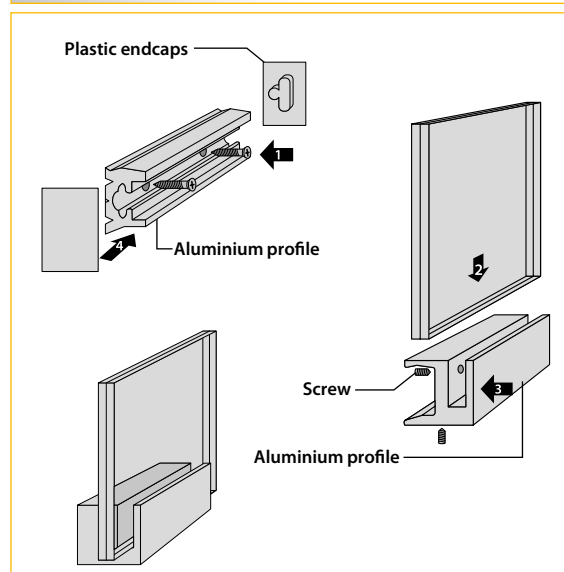

### Simple Profile

15.571		105x105mm	
15.572		105x149mm	
15.573		149x105mm	
15.574		149x149mm	
15.575		149x210mm	
15.576		210x149mm	
15.577		297x105mm	
15.578		297x149mm	
15.579		297x210mm	
15.580		420x149mm	
15.581		594x149mm	
15.582		840x149mm	
15.583		840x210mm	

### Double Profile

15.584		210x297mm	
15.585		297x420mm	
15.586		297x594mm	
15.587		420x297mm	
15.588		594x420mm	
15.589		840x149mm	
15.590		594x840mm	

## Sign System Data Frame

Sign system with plastic profile. Available in three different sizes. Easy and quick to change the information graphic paper.

**Material:** Plastic.

15.200		149x63mm	
15.201		149x105.5mm	
15.202		149x148.5mm	

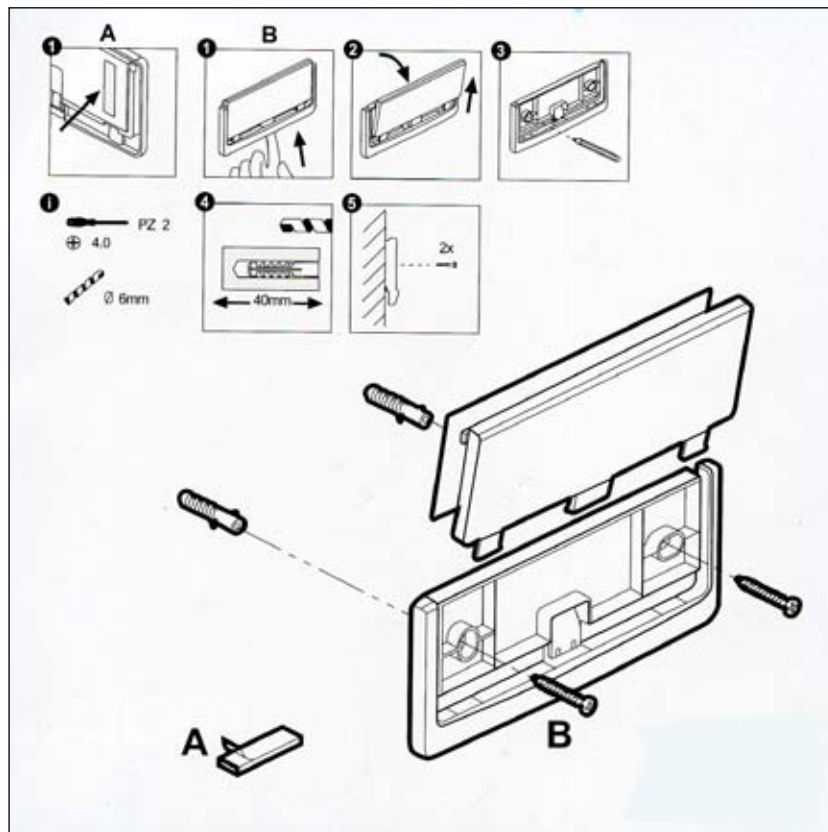

## Sing System Straight-Curve

Aluminium wall signs. STRAIGHT (Bargello) or CURVE (Orsay) aluminium lateral profile. Complete kits. Includes:

- STRAIGHT or CURVE lateral aluminium profile.
- Plastic pieces for fixing.
- Aluminium straight sign profile.
- Plastic endcaps.

\* Indoor use: office, bathroom, building, etc.  
\* Easy and quick to assemble.

**Material:** Aluminium, plastic parts.

### Bargello

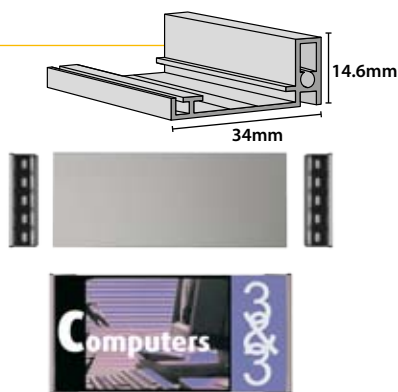

15.634	60x120mm	
15.635	60x220mm	
15.636	60x300mm	
15.637	90x150mm	
15.638	90x220mm	
15.639	90x300mm	
15.668	124x120mm	
15.640	124x150mm	
15.641	124x220mm	
15.642	124x300mm	
15.670	150x150mm	
15.643	150x220mm	
15.644	150x300mm	
15.645	150x400mm	
15.672	180x180mm	
15.646	60x500mm	
15.647	90x500mm	
15.648	124x500mm	
15.649	150x500mm	
15.650	180x500mm	

Install explain:

1. Make holes in the oval plastic pieces there are in the covers side. (If you will fix with double face adhesive don't make this step).
2. Fix and fasten the groove with screws.
3. Push the aluminium pictogram over the lateral profiles.

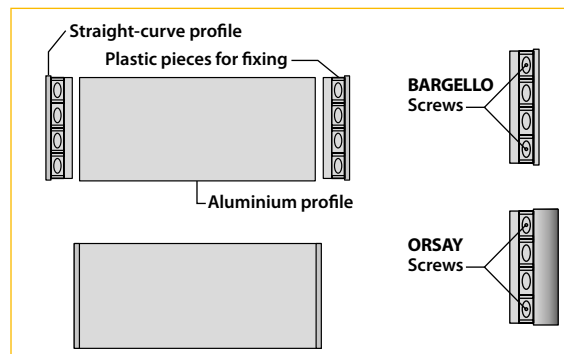

### Orsay

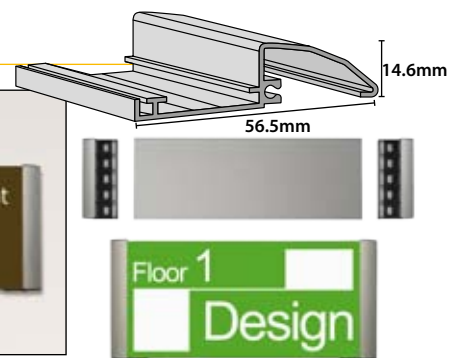
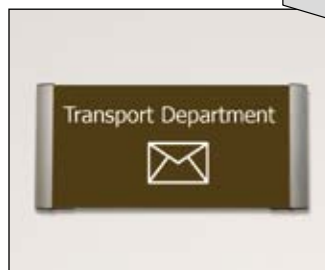

15.651	60x120mm	
15.652	60x220mm	
15.653	60x300mm	
15.654	90x150mm	
15.655	90x220mm	
15.656	90x300mm	
15.657	124x150mm	
15.658	124x220mm	
15.659	124x300mm	
15.660	150x220mm	
15.661	150x300mm	
15.662	150x400mm	
15.663	60x500mm	
15.664	90x500mm	
15.665	124x500mm	
15.666	150x500mm	
15.667	180x500mm	



## Sign System Curve "Hermitage"

Aluminium wall sign "CURVE". Different sizes are available.

Complete kits. Includes:

- \* Aluminium curve sign profile.
- \* Indoor use: office, building, shops, etc.
- \* Easy and quick to assemble.

**Material:** Aluminium, plastic parts.



15.696	70x215mm	
15.697	70x270mm	
15.698	70x425mm	
15.699	70x530mm	
15.700	70x600mm	
15.701	140x215mm	
15.702	140x270mm	
15.703	140x425mm	
15.704	140x530mm	
15.705	140x600mm	

15.706	210x215mm	
15.707	210x270mm	
15.708	210x425mm	
15.709	210x530mm	
15.710	210x600mm	
15.711	245x215mm	
15.712	245x270mm	
15.713	245x425mm	
15.714	245x530mm	
15.715	245x600mm	

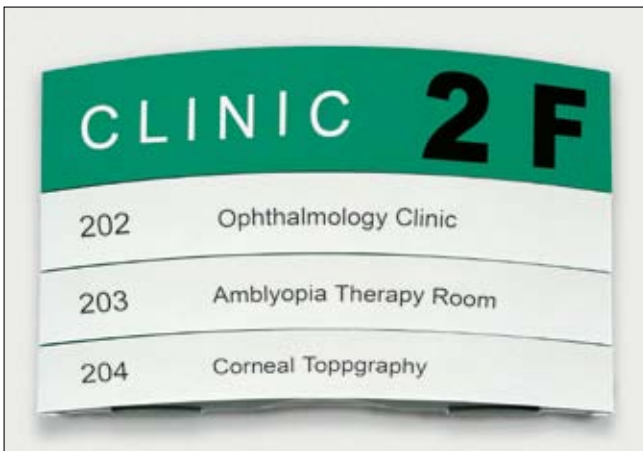

### Profile (Price for linear meter)



If you need make a own directory, we have a aluminium profile that facilitates their assembly. This profile replacing those that are included in each kit in his back side and allows fix several curve sign with only one aluminium profile. Price for linear meter.

**Material:** Aluminium.

15.718	60mm	
--------	------	--

Install explain:

1. Using the covers of the directory as a reference point for fixing. (Fig. 1 and 2).
2. The size of the directory will give us the distance to set the second support. (Fig. 3 and 4).
3. Check the position. (Fig. 5 and 6).
4. Mark the top distance and set the following covers and profile. (Fig. 7, 8 and 9).
5. For finish, put the insurance. (Fig. 10).

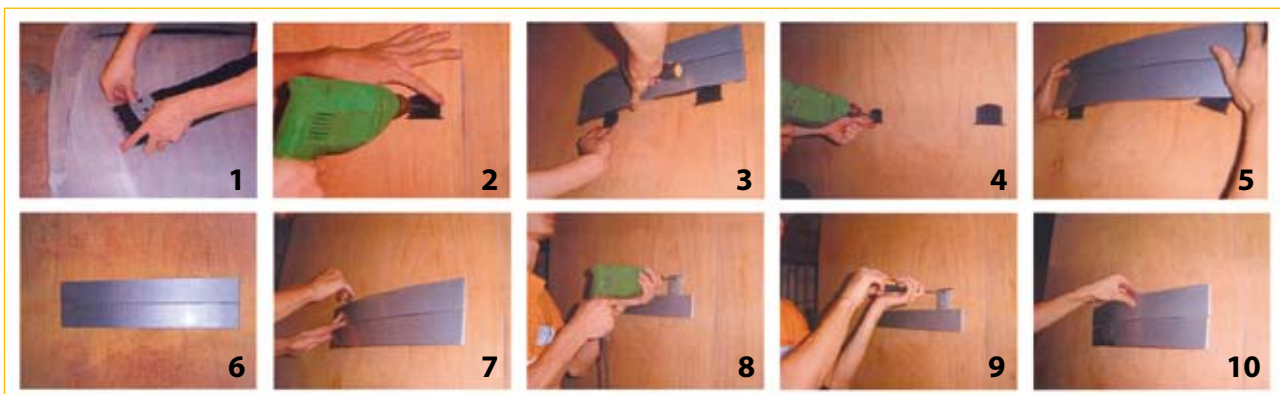

## Sign System Curve "Beyeler"

Sign system with curve profile. Available in 3 different widths. This system allows the composition of directories wall according to customer needs. The components of the system are supplied separately.

**Material:** Aluminium, plastic parts.

### Aluminium sign profile

Price for linear meter. (Includes plastic protector).

**Material:** Aluminium.

10.224	60mm	
10.225	90mm	
10.226	140mm	

### Profile Cut

10.233	
--------	--



### Accessories

#### Plastic Endcaps for 60mm profiles

10.227	<input type="checkbox"/>	Pack 10 Uni.	
10.230	<input checked="" type="checkbox"/>	Pack 10 Uni.	

#### Plastic Endcaps for 90mm profiles

10.228	<input type="checkbox"/>	Pack 10 Uni.	
10.231	<input checked="" type="checkbox"/>	Pack 10 Uni.	

#### Plastic Endcaps for 140mm profiles

10.229	<input type="checkbox"/>	Pack 10 Uni.	
10.232	<input checked="" type="checkbox"/>	Pack 10 Uni.	



## Sign System Curve "Special"

Curved profile wall "Special" with silver anodised aluminium frame. Includes transparent sleeve allows you to add paper with text or pictograms. Complete kits. Fixing by screws or double face adhesive.

Includes:

- Curved aluminium profile.
- Two plastic endcaps.
- Aluminium directory.

\* Indoor use: office, warehouse, shops, etc.

\* Easy and quick to assemble.

**Material:** Aluminium, plastic parts.

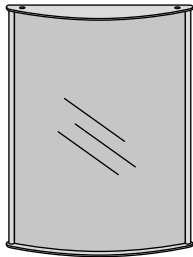

15.614	200x200mm	
15.615	200x250mm	
15.616	200x300mm	
15.617	300x400mm	
15.618	500x500mm	

### Install explain:

1. Fix the aluminium alloy arc, aluminium slice and plastic fittings together by screws, then fix on the place where you need.
2. Conglutinate transparency to aluminium-plastic composite panel.
3. Put the hitch plastic fittings and main faceplate together.

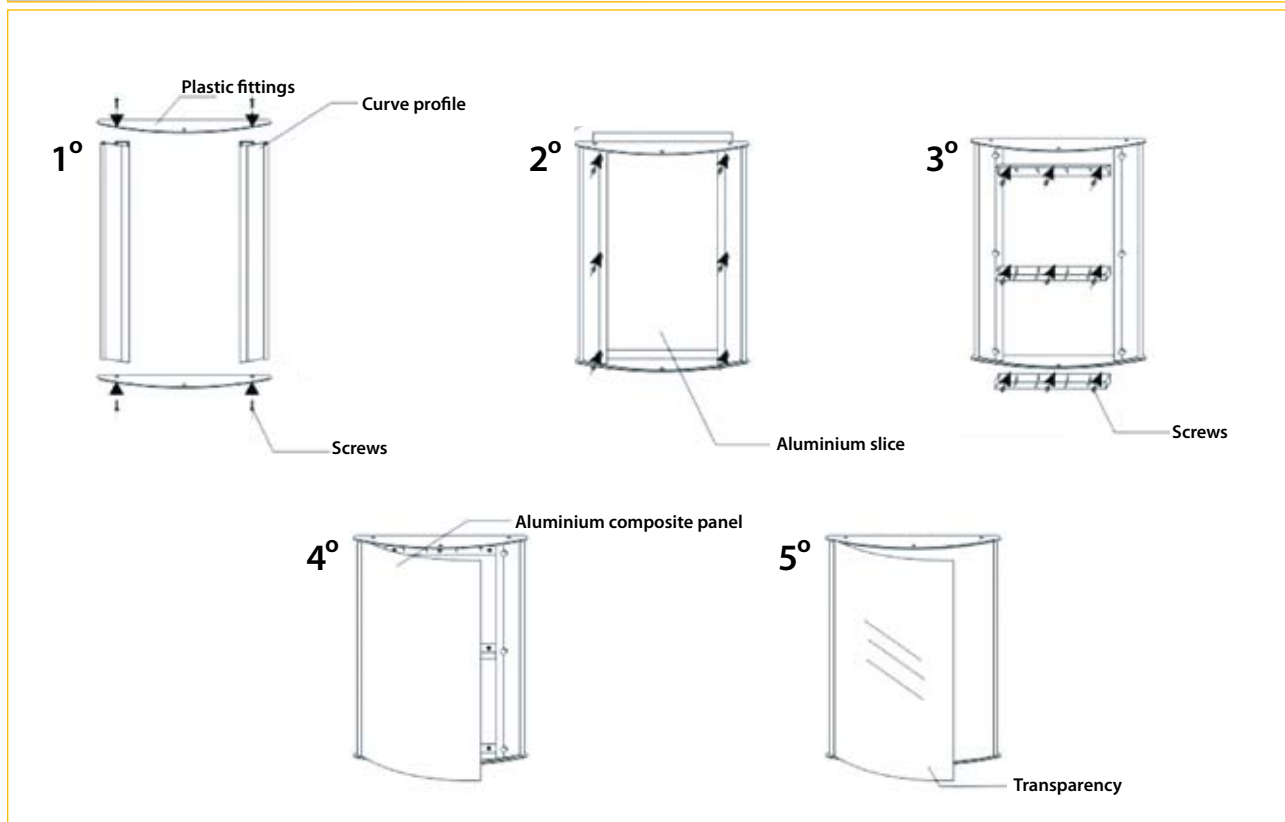

## Curve Flag Sign

Curve flag sign. Aluminium double sided flag wall. Mount any projected wall sign with screws. Complete kits. Includes:

- Aluminium double sided profile.
- Aluminium fittings.
- Plastic endcaps.
- Transparent sleeve.

\* Indoor use: office building, shops, public places, etc.

\* Easy and quick to assemble. Screws not included.

**Material:** Aluminium, plastic parts.

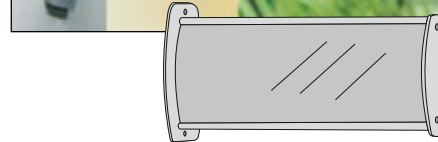
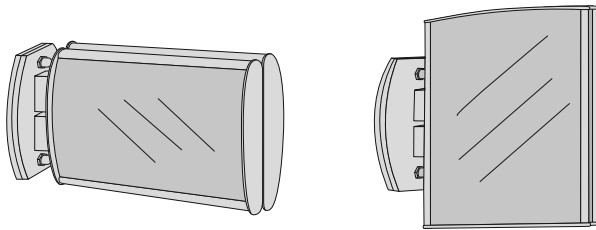

### Curve Flag Sign (with separator)

15.619	115x150mm	
15.620	115x180mm	
15.621	115x220mm	
15.625	150x150mm	
15.626	150x180mm	
15.622	150x115mm	
15.623	180x115mm	
15.624	220x115mm	
15.627	180x150mm	
15.628	200x150mm	

### Curve Flag Sign (direct to wall)

15.629	115x220mm	
15.630	115x280mm	
15.631	115x300mm	
15.632	150x150mm	
15.633	150x250mm	

Install explain(with separator):

1. Fix arc aluminium double-sided sign bottom and faceplate together.
2. Lock plastic fitting and arc aluminium double-sided faceplate together.
3. Conglutinate transparency into arc aluminium double-sided faceplate.
4. Fix the dinished double-sided sign on the place where you need by screw.

Install explain(direct to wall):

1. Fix arc aluminium double-sided sign bottom and faceplate together.
2. Lock plastic fitting and arc aluminium double-sided faceplate together.
3. Conglutinate transparency into arc aluminium double-sided faceplate.
4. Fix the finished double-sided sign on the place where you need by screw.

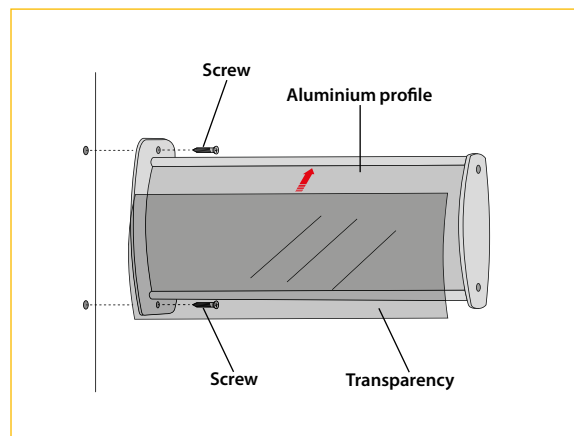
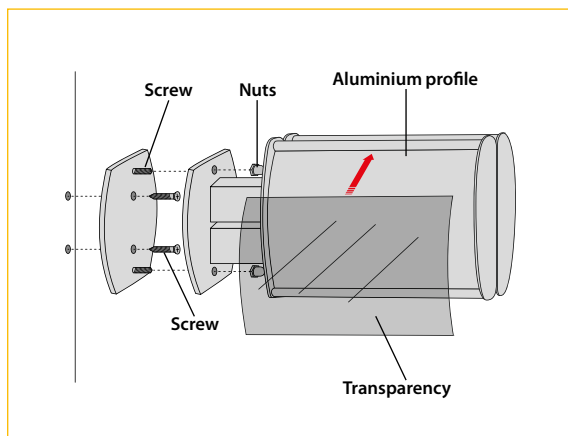

## Straight Flag Sign

Straight flag sign. Aluminium double sided flag wall. Mount any projected wall sign with screws. Complete kits includes:

- Aluminium double sided profile.
- Aluminium fittings.
- Plastic endcaps.

\* Indoor use: corridors, office building, commercial centres, etc.  
 \* Easy and quick to assemble.

**Material:** Aluminium, plastic parts.



15.685	90x220mm	
15.686	90x320mm	
15.687	124x220mm	
15.688	124x320mm	
15.689	124x420mm	
15.690	150x150mm	
15.691	150x220mm	
15.692	150x320mm	
15.693	150x420mm	



Install explain:

1. Fix straight aluminium double-sided profile.
2. Put the plastic endcaps.
3. Make two holes.
4. Fix and fasten the groove with the screws on the bottom part.
5. Introduce the profile in the support.
6. Screw the top part and put in the plastic endcaps.

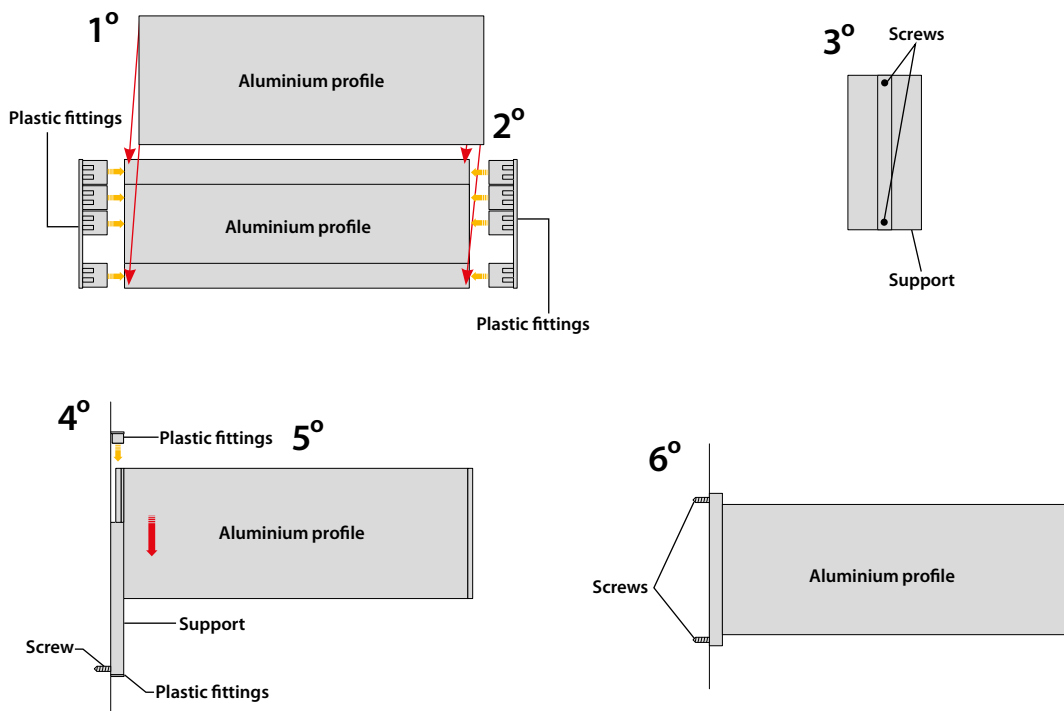

## Outdoor Sign

Consist in aluminium post fixed to the outdoor floor. Double side.  
Outdoor use: warehouse, building, office, etc.

**Material:** Aluminium, plastic parts.

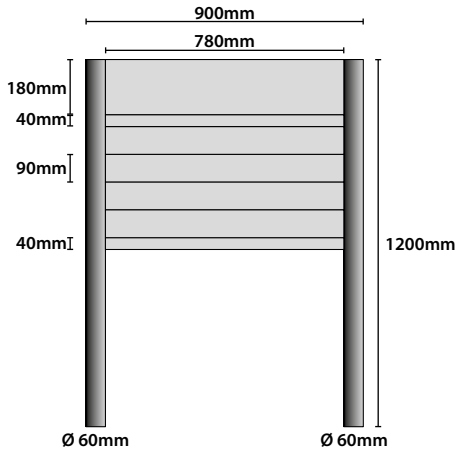

Includes:

- 2 aluminium post 1200mm x Ø 60mm.
- 2 plastic post endcaps.
- 1 aluminium profile 180mm wide.
- 2 aluminium profile 40mm wide.
- 4 aluminium profile 90mm wide.

15.716

900x1200mm

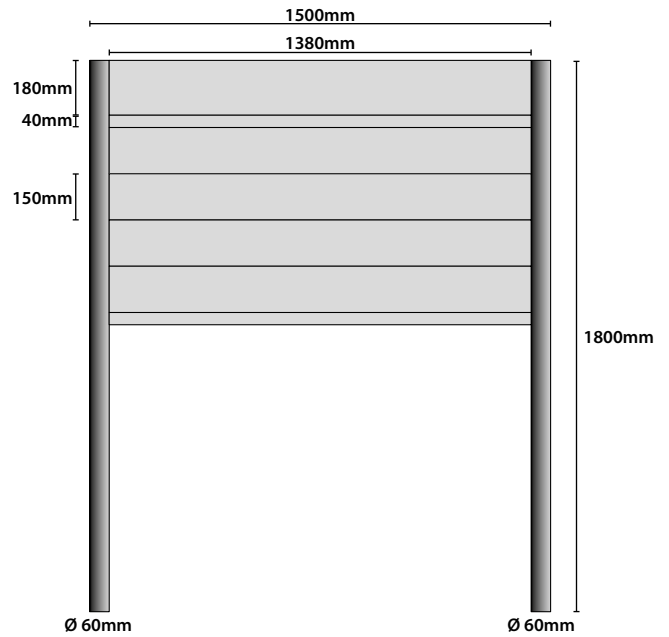

Includes:

- 2 aluminium post 1800mm x Ø 60mm.
- 2 plastic post endcaps.
- 1 aluminium profile 180mm wide.
- 2 aluminium profile 40mm wide.
- 4 aluminium profile 150mm wide.

15.717

1500x1800mm



## Suspended Signs

Aluminium suspended signs. Double sided. Complete kits. Includes:

- Aluminium profile.
- Steel wire.
- Endcaps.

\* Indoor use: corners, corridors, sections, office, etc.

\* Easy and quick to assemble.

**Material:** Aluminium, steel wire, plastic parts.

15.673	90x500mm	
15.674	124x500mm	
15.675	124x650mm	
15.676	150x500mm	
15.677	150x650mm	



## Desk Signs

Straight desk signs. Aluminium tabletop signs. Complete kits. Easy and fast to assemble. Includes:

- Aluminium metal alloy face plate.
- L-plastic fitting.
- Plastic endcaps.

\* Indoor use: tabletop, desk counters, receptions, etc.

**Material:** Aluminium, plastic parts.

15.611	100x200mm	
15.612	100x250mm	
15.613	100x280mm	



Install explain:

1. Put aluminium faceplate fasten with screw.
2. Fix plastic fitting on the faceplate two side by screw.
3. Make the L-plastic fitting cover aluminium faceplate.

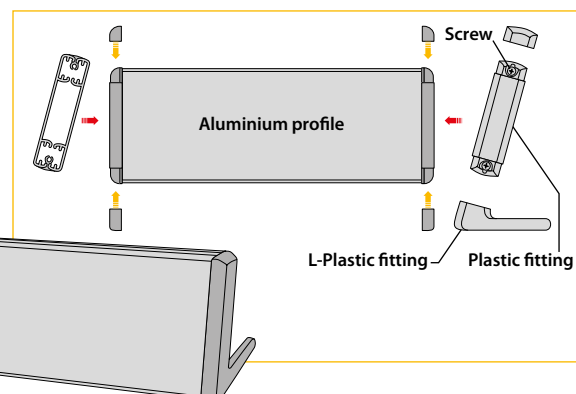

## Curve Desk Sign

Curve desk sign. Aluminium tabletop signs. Complete kits. Easy and fast to assemble. Includes:

- Main faceplate/arc aluminium metal alloy.
- Transparent sleeve.
- Plastic fitting.

\* Indoor use: Tabletop, desk, counters, receptions, etc.

**Material:** Aluminium, plastic parts.

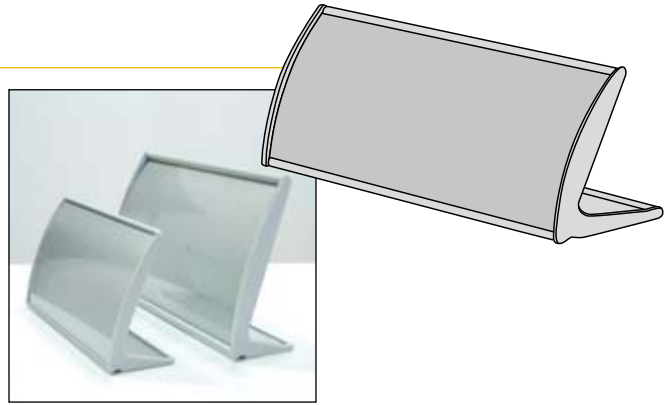

Install explain:

1. Conglutinate transparency to aluminium metal alloy faceplate.
2. Put left and right fittings together with aluminium metal alloy faceplate.
3. Hitch fitting and aluminium metal alloy faceplate together.

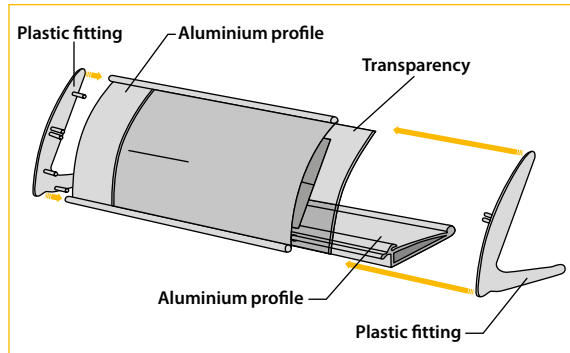

15.599	115x180mm	
15.600	115x200mm	
15.601	115x250mm	
15.602	115x350mm	
15.603	150x300mm	

## Vertical

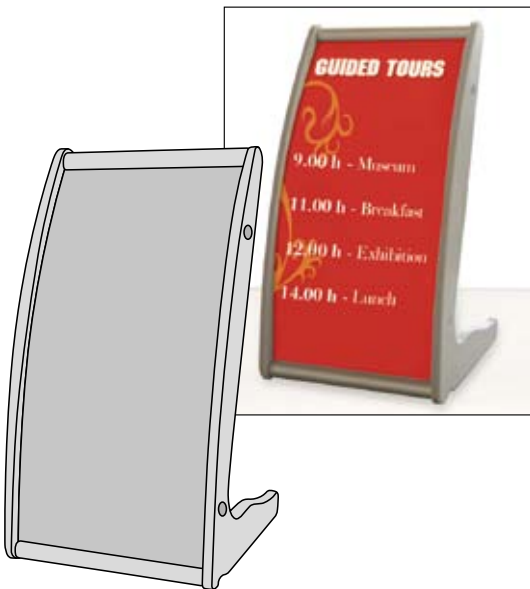

15.604	210x297mm	
15.605	210x200mm	
15.606	210x150mm	
15.607	210x100mm	

## Horizontal

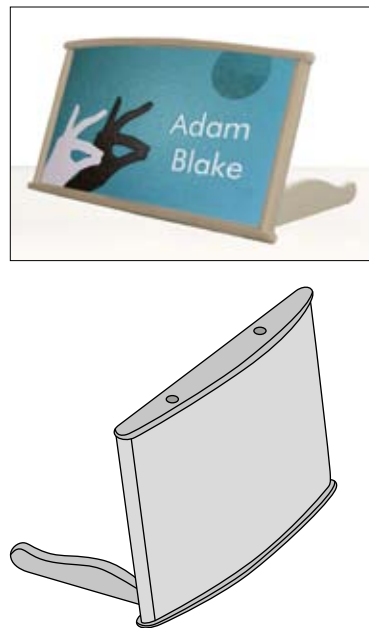

15.608	297x210mm	
15.609	150x210mm	
15.610	100x210mm	



## Desk Sign Steel Support

Desk sign steel support. Gold or chrome finished. Includes two steel support.

\* Indoor use: counters, desk receptions, etc.  
\* Easy and quick to assemble.

**Material:** Steel.



15.567	8x80mm	Pack 2 Uni.	<input type="text"/>
15.568	8x80mm	Pack 2 Uni.	<input type="text"/>
15.569	8x80mm	Pack 2 Uni.	<input type="text"/>
15.570	8x80mm	Pack 2 Uni.	<input type="text"/>



## Wall Profile

Wall profile system. Easy and fast to assemble. One can simply open the front profile to change your documents. Two colours are available, silver or gold. Includes:

- Aluminium profile.
- Plastic endcaps.

\* Indoor use: office, conference room, etc.

**Material:** Aluminium, plastic parts.



15.591	140mm	<input type="text"/>
15.592	290mm	<input type="text"/>
15.593	440mm	<input type="text"/>
15.594	890mm	<input type="text"/>



15.595	140mm	<input type="text"/>
15.596	290mm	<input type="text"/>
15.597	440mm	<input type="text"/>
15.598	890mm	<input type="text"/>



Install explain:

1. Connect one locking hook opener with other locking hook opener.
2. Put combined locking hook opener inside the aluminium profile.
3. Cover plastic in both side.

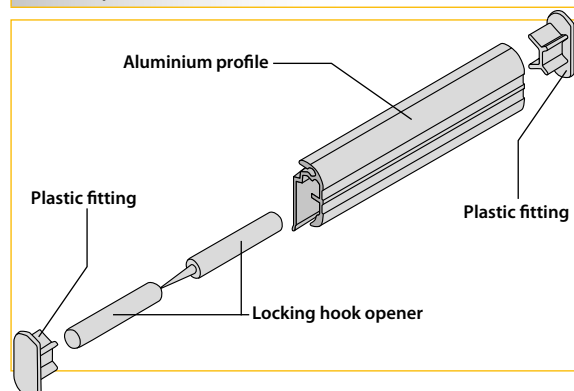

## Wall Mount Aluminium Panel Support

Wall mount aluminium panel support for fixing signs. Colour: silver.

Includes:

- Stand-Offs with 6 LED bulbs.
- Power supply.
- Plug and wires.

**Material:** Aluminium.

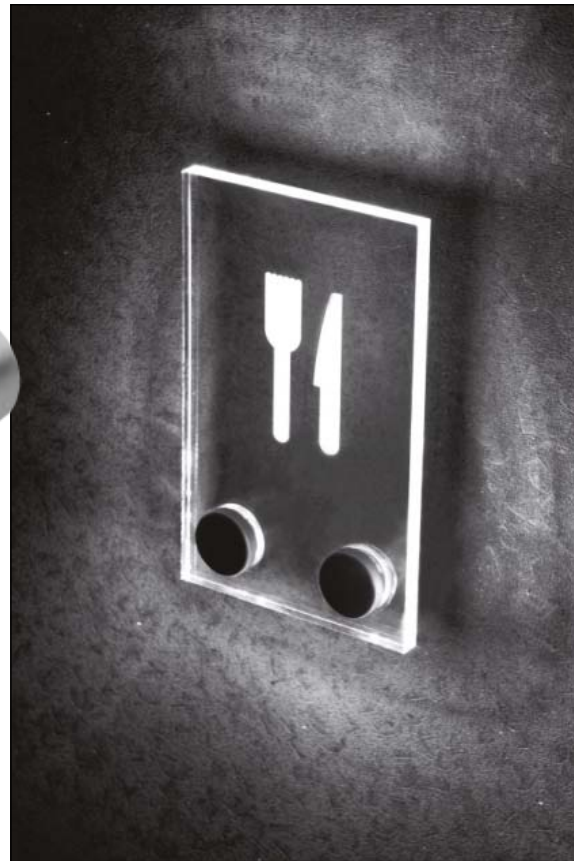

15.724    25x25mm    Pack 4 Uni.



## Sign System with LED Light

Sign system with LED lights. Includes:

- Aluminium satin profile.
- White colour LEDs inside.
- Power supply.
- Plug and wires.

Suitable for glass or acrylic up to 8mm of thickness.

**Material:** Aluminium.

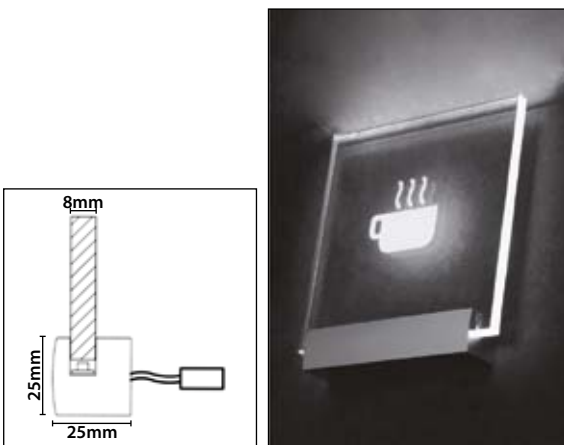

15.725    120mm    9 LEDs



15.726    180mm    12 LEDs



15.727    280mm    21 LEDs



## Wallmount Panel Supports

Wallmount through hole panel supports. These wallmount panel support are available in gold or chrome colour. Use: indoor/outdoor.

**Material:** Steel.

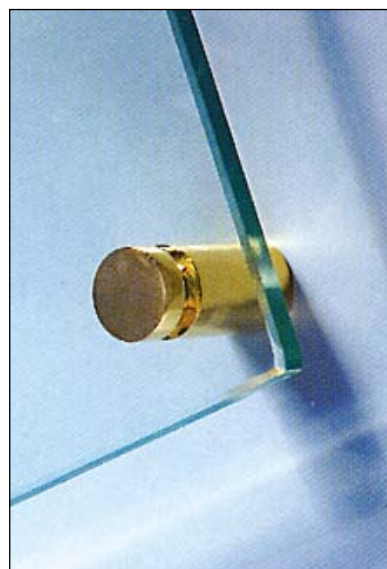

### Ø 13mm

15.500	13x13mm	Pack 4 Uni.	<input type="text"/>
15.501	13x19mm	Pack 4 Uni.	<input type="text"/>
15.502	13x25mm	Pack 4 Uni.	<input type="text"/>
15.503	13x40mm	Pack 4 Uni.	<input type="text"/>
15.504	13x13mm	Pack 4 Uni.	<input type="text"/>
15.505	13x19mm	Pack 4 Uni.	<input type="text"/>
15.506	13x25mm	Pack 4 Uni.	<input type="text"/>
15.507	13x40mm	Pack 4 Uni.	<input type="text"/>



### Sizes

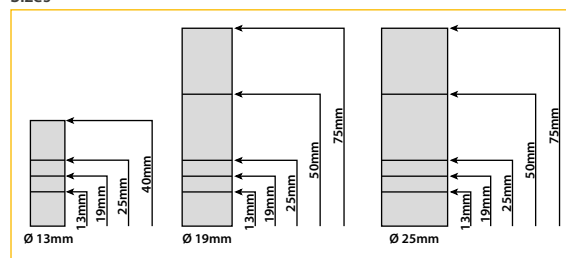

### Ø 19mm

15.508	19x13mm	Pack 4 Uni.	<input type="text"/>
15.509	19x19mm	Pack 4 Uni.	<input type="text"/>
15.510	19x25mm	Pack 4 Uni.	<input type="text"/>
15.511	19x50mm	Pack 4 Uni.	<input type="text"/>
15.512	19x75mm	Pack 4 Uni.	<input type="text"/>
15.513	19x13mm	Pack 4 Uni.	<input type="text"/>
15.514	19x19mm	Pack 4 Uni.	<input type="text"/>
15.515	19x25mm	Pack 4 Uni.	<input type="text"/>
15.516	19x50mm	Pack 4 Uni.	<input type="text"/>
15.517	19x75mm	Pack 4 Uni.	<input type="text"/>



### Ø 25mm

15.518	25x13mm	Pack 4 Uni.	<input type="text"/>
15.519	25x19mm	Pack 4 Uni.	<input type="text"/>
15.520	25x25mm	Pack 4 Uni.	<input type="text"/>
15.521	25x50mm	Pack 4 Uni.	<input type="text"/>
15.522	25x75mm	Pack 4 Uni.	<input type="text"/>
15.523	25x13mm	Pack 4 Uni.	<input type="text"/>
15.524	25x19mm	Pack 4 Uni.	<input type="text"/>
15.525	25x25mm	Pack 4 Uni.	<input type="text"/>
15.526	25x50mm	Pack 4 Uni.	<input type="text"/>
15.527	25x75mm	Pack 4 Uni.	<input type="text"/>



# WALLMOUNT PANEL SUPPORTS

10

## Wallmount Aluminium Panel Supports

These wallmount panel support are available in a range of finisher to complement your display. Available in different colours. Use: indoor/outdoor.

**Material:** Aluminium.



### Ø 13mm

15.528

15.532

15.536

15.540  13x13mm Pack 4 Uni.

15.529

15.533

15.537

15.541  13x19mm Pack 4 Uni.

### Ø 19mm

15.530

15.534

15.538

15.542  19x25mm Pack 4 Uni.

### Ø 25mm

15.531

15.535

15.539

15.543  25x30mm Pack 4 Uni.

## Screw Covers

Attractive screw covers, without distances. Different cover sizes are available. Indoor/outdoor use.

**Material:** Steel.

15.544 Ø 15mm Pack 4 Uni.

15.545 Ø 19mm Pack 4 Uni.

15.546 Ø 25mm Pack 4 Uni.



15.547 Ø 15mm Pack 4 Uni.

15.548 Ø 19mm Pack 4 Uni.

15.549 Ø 25mm Pack 4 Uni.



## Glass System Sign

Acrylic System sign. Includes two acrylic 3mm. thickness. Easy and quick to assemble. Indoor use : office, building, shops, etc.

**Material:** Acrylic and aluminium.

15.203	297x120mm		
15.204	120x297mm		
15.205	210x297mm		
15.206	210x210mm		

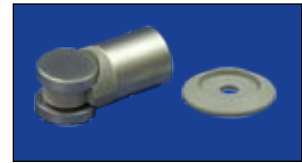
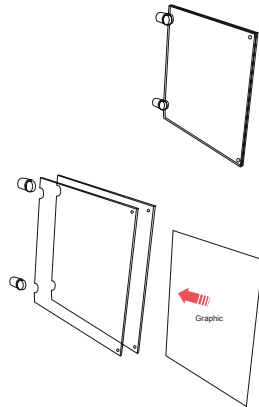
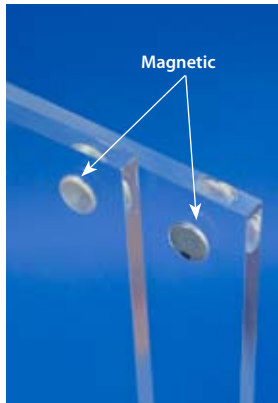
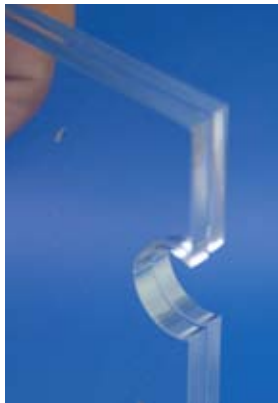

## Acrylic Data Frame

Versatile and simple sign system made in acrylic. Easy and quick to assemble. Indoor use : office, building, shops, etc.

**Material:** Acrylic.

15.208	66x66mm	
15.207	199x66mm	



Ref. 15.207



Ref. 15.208

## Panel Support



Panel support for up to 12mm or 9.5mm thick. Chrome or gold colour.

**Material:** Steel.



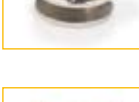

15.558	35x35mm	12mm	Pack 4 Uni.	<input type="text"/>	
15.560	25x25mm	9.5mm	Pack 4 Uni.	<input type="text"/>	
15.559	35x35mm	12mm	Pack 4 Uni.	<input type="text"/>	
15.561	25x25mm	9.5mm	Pack 4 Uni.	<input type="text"/>	



15.554	30mm	7.5mm	Pack 2 Uni.	<input type="text"/>	
15.555	50mm	9.5mm	Pack 2 Uni.	<input type="text"/>	
15.556	30mm	7.5mm	Pack 2 Uni.	<input type="text"/>	
15.557	50mm	9.5mm	Pack 2 Uni.	<input type="text"/>	





15.562	80x28mm		Pack 4 Uni.	<input type="text"/>	
15.563	50x25mm		Pack 4 Uni.	<input type="text"/>	



## "Square" Side Grip

These fixing are mounted at the side. They hold materials up to 10mm thick on the vertical or horizontal edge. Chrome or gold colour. For indoor and outdoor use.

**Material:** Steel.

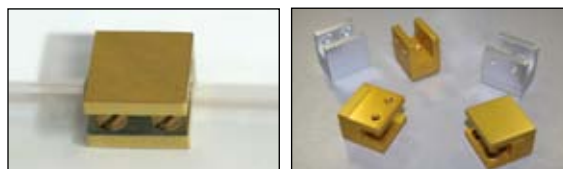

15.564	25x25mm	Pack 4 Uni.	<input type="text"/>	
15.565	25x25mm	Pack 4 Uni.	<input type="text"/>	



## Side Grip

These fixing are mounted at the side. The materials, like glass, mirrors, leaded glass or another can easily mounted on the wall without drilling any holes. They hold material up to 8 to 10mm thick. For indoor and outdoor use.

**Material:** Steel.

15.550	20x25mm	Pack 4 Uni.	<input type="checkbox"/>	
15.551	20x30mm	Pack 4 Uni.	<input type="checkbox"/>	
15.552	20x25mm	Pack 4 Uni.	<input type="checkbox"/>	
15.553	20x30mm	Pack 4 Uni.	<input type="checkbox"/>	



## Cube System

Panel connector. This range of connectors for 6mm. glass panels is ideal for use where goods need to be promoted and presented in an attractive way. Includes 4 units in each pack. Available in different colours.

**Material:** Steel.

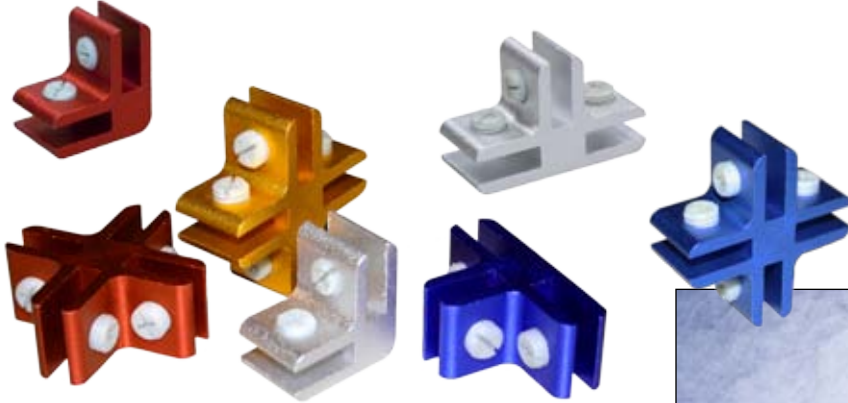

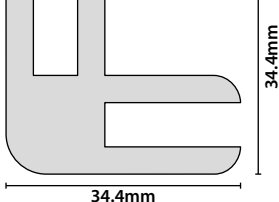
15.182	<input type="checkbox"/>	Pack 4 Uni.	<input type="checkbox"/>	
15.183	<input type="checkbox"/>			
15.184	<input type="checkbox"/>			
15.185	<input type="checkbox"/>			
15.186	<input type="checkbox"/>			

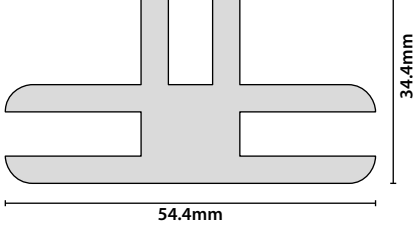
15.187	<input type="checkbox"/>	Pack 4 Uni.	<input type="checkbox"/>	
15.188	<input type="checkbox"/>			
15.189	<input type="checkbox"/>			
15.190	<input type="checkbox"/>			
15.191	<input type="checkbox"/>			

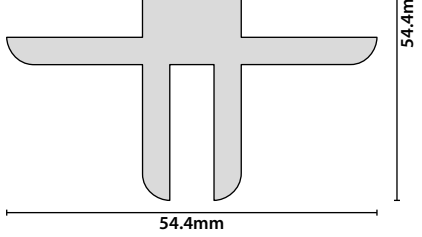
15.192	<input type="checkbox"/>	Pack 4 Uni.	<input type="checkbox"/>	
15.193	<input type="checkbox"/>			
15.194	<input type="checkbox"/>			
15.195	<input type="checkbox"/>			
15.196	<input type="checkbox"/>			





# 11



sign accessories

## Wool Squeegees



Felt squeegees which allows an easier application of vinyl. Available in two types of quality. Product density: 0.50gm/cm<sup>3</sup>.

**Material:** Wool.

16.012 100x70x13mm Pack 10 Uni.  

16.013 100x70x13mm Pack 10 Uni.  

## Semicircle Wool Squeegees



Felt squeegees which allows an easier application of vinyl/application tape. Available in two types of quality. Product density: 0.50gm/cm<sup>3</sup>.

**Material:** Wool.

16.014 130x70x13mm Pack 10 Uni.  

16.015 130x70x13mm Pack 10 Uni.  

## Plastic Squeegees



Squeegees of double bladed, which allows easier application of vinyl / application tape. Available in two different sizes.

**Material:** Plastic.

16.003 100x70mm Pack 10 Uni.

16.004 130x70mm Pack 10 Uni.

## Rubber Squeegees

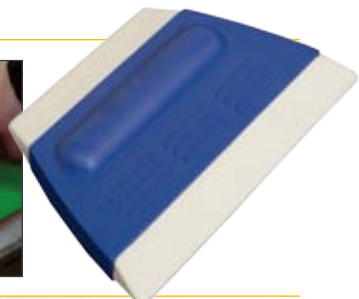

Rubber squeegee of double bladed, which allows easier application of vinyl / application tape.

**Material:** Plastic, rubber.

16.005 100x70mm Pack 10 Uni.

## Removal Tool

The vinyl removal tool an helps with the removal of adhesive from surfaces.

**Material:** Plastic.

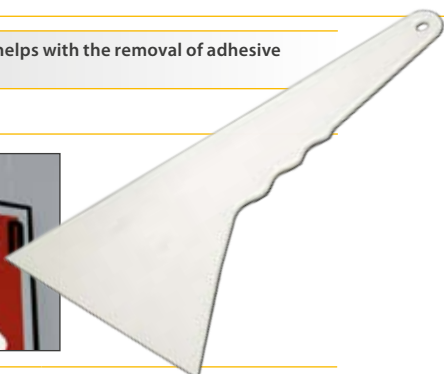

16.000 108x240mm Pack 10 Uni.



16.001 60x135mm Pack 10 Uni.



16.002 90x115mm Pack 10 Uni.



16.006 20x150mm Pack 10 Uni.

## Application Roller



The roller applicator allows firm 90° downward pressure when applying pressure sensitive adhesive materials such as vinyl, without scratching the surface.

**Material:** Steel, plastic.

16.009

## Rivet Brush



Wood handle with stiff bristles which aids in applying vinyl to brick, stucco, banners, etc. Also used when applying graphics on vehicles.

**Material:** Wood.

16.011

## Magnetic Ring



Magnetic ring for fixing vinyl.

**Material:** Steel.

16.124

## Magnetic Base



Magnetic base with knob.

**Material:** Steel, plastic.

16.125

## Suction-Cup

Suction-cup for carrying heavy panels, such as PVC, wood and other hard-to-carry. Lets you carry large panels safely and easily. Available single, double or triple. Ø 120mm.

**Material:** Plastic, rubber.



16.016    Simple    Capacity 30kg



16.017    Double    Capacity 60kg



16.018    Triple    Capacity 120kg





## Magnetic Insert Discs

Nickel plated neodymium magnets.

**Material:** Neodymium.



**16.080**     $\varnothing 8 \times 3 \text{mm}$     Pack 10 Uni.

**16.081**     $\varnothing 10 \times 3 \text{mm}$     Pack 10 Uni.

**16.082**     $\varnothing 20 \times 5 \text{mm}$     Pack 10 Uni.

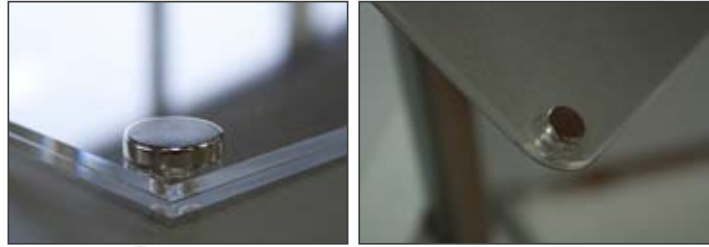
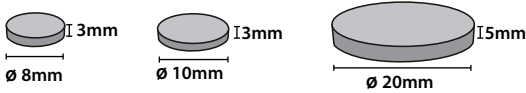

## Ferrite Magnetic Base

Ferrite Magnetic base.

**Material:** Ferrite/Steel.

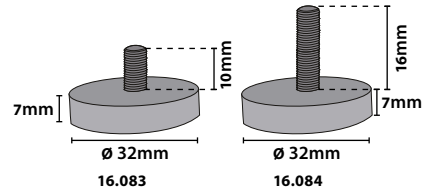

**16.083**    Base:  $\varnothing 32 \times 7 \text{mm}$   
Screw:  $\varnothing 6 \times 10 \text{mm}$     Pack 10 Uni.

**16.084**    Base:  $\varnothing 32 \times 7 \text{mm}$   
Screw:  $\varnothing 6 \times 16 \text{mm}$     Pack 10 Uni.

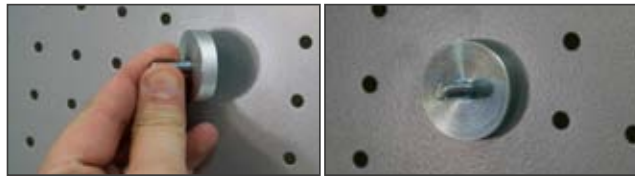

## Neodymium Magnetic Base

Neodymium Magnetic base.

**Material:** Neodymium/steel.

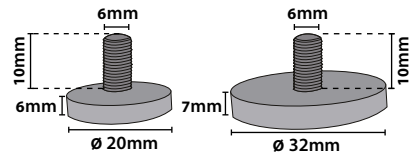

**16.085**    Base:  $\varnothing 20 \times 6 \text{mm}$   
Screw:  $\varnothing 6 \times 10 \text{mm}$     Pack 10 Uni.

**16.086**    Base:  $\varnothing 32 \times 7 \text{mm}$   
Screw:  $\varnothing 6 \times 10 \text{mm}$     Pack 10 Uni.

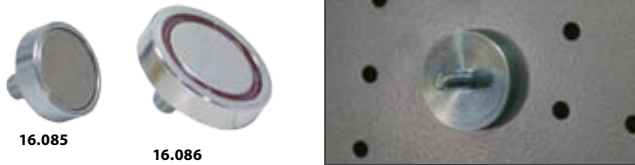

## Magnetic Strip Roll



Magnetic strip roll.

	QTY	N.W (kg)	G.W (kg)	C.B.M.	Size(mm)
Packing	10	9	10	0.02	290x290x200

**10.360**    12mm

Magnetic Strip with adhesive. Anisotropic.

**16.087**     $\text{ml} \times 1.2 \text{mm}$

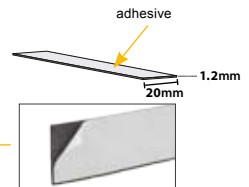

Magnetic Strip without adhesive. Anisotropic.

**16.088**     $\text{ml} \times 1.2 \text{mm}$

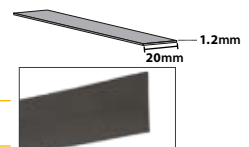

## Magnetic Data Strip



Magnetic data strip for labels.

**Material:** Magnet Flexible Ferrite.

**16.089**    **25mm**



**16.090**    **35mm**



**16.091**    **40mm**

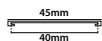

**16.092**    **50mm**



## Magnetic Sheet Anisotropic

Magnetic Sheet 2 mm. Anisotropic.

**Material:** Magnet Sheet Ferrite.

**16.093**    **150x100x2mm**

**16.094**    **950x400x2mm**



## Magnetic Roll Anisotropic

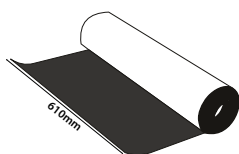

Magnetic roll with PVC white one face.

**Material:** Magnet Ferrite.

**16.095**    **610mm x 50mts x 0.6mm**

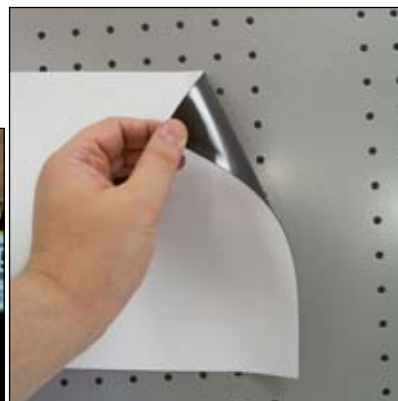

## Magnetic Wrist Holder



Magnetic wrist holder.

**Material:** Fabric, steel.

16.126

## Cleaning Swab



The cleaning swab suitable for cleaning the printheads, keyboards, digital printers. It's soft and easy for cleaning.

**Material:** Plastic, fabric.

16.008

Pack 10 Uni.

## Magnetic Ruler



1000mm / 36" magnetic ruler.

**Material:** Plastic.

16.122

1000mm / 36"



1000mm magnetic ruler.

**Material:** Plastic.

16.123

1000mm

## Meter



19x5000mm meter. Brake and magnetic hook included.

**Material:** Steel, plastic.

16.076

19x5000mm

## Measuring Stick



30 or 50m measuring stick.

**Material:** Steel, plastic.

16.070

30000mm

16.071

50000mm

## Meter

Several measures meter. Brake included.

**Material:** Steel, plastic.

16.072

13x2000mm

Pack 5 Uni.

16.073

16x3000mm

Pack 5 Uni.

16.074

19x5000mm

Pack 5 Uni.

16.075

25x10000mm

Pack 5 Uni.



## Linen Tester

Linen tester, 5x.

**Material:** Plastic.

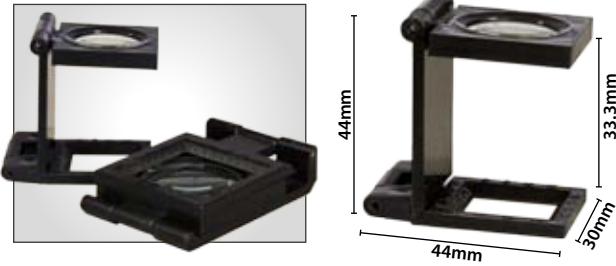

16.077

33.3mm



16.078

50mm

## Linen Tester Luxe

Linen tester luxe, leather box. 25x.

**Material:** Plastic.

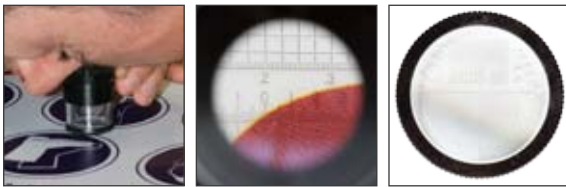

16.079

Ø 25 x 53mm



## Hand Caliber

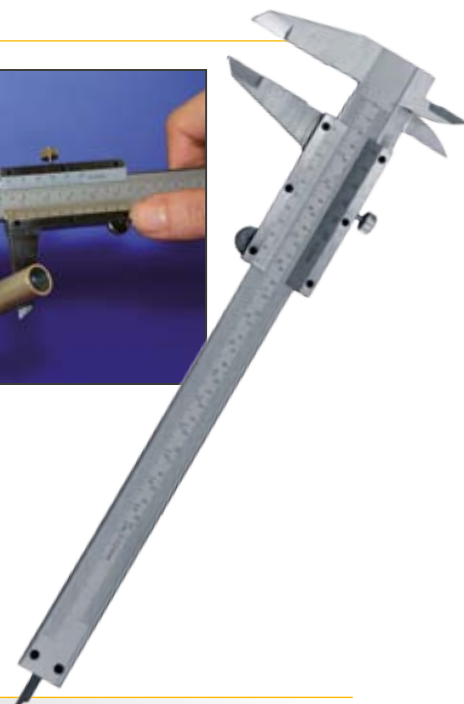

0-150mm hand caliber.

**Material:** Steel.

16.058

## Digital Caliber



0-150mm electronic digital caliber.

**Material:** Steel, plastic parts.

16.057

## Electronic Digital Micrometer

0.001-100mm electronic digital micrometer.

**Material:** Steel, plastic parts.



16.059

## Special Accuracy Weighing Machine

Precision balance. Weigh capacity: 0.01-300gr. or 0.1-500gr.

**Material:** Steel, plastic.



16.055      0.1 - 500gr

16.056      0.01 - 300gr

## Long Table Cutter

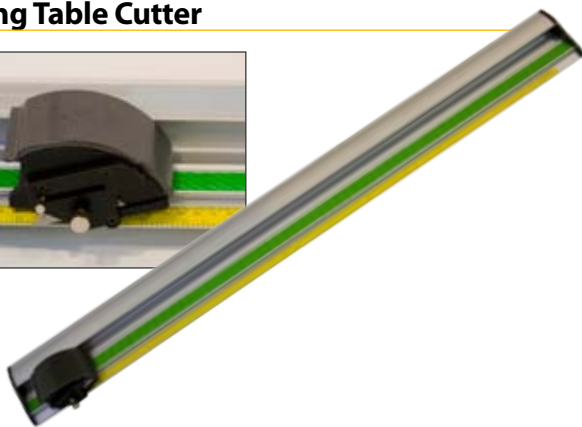
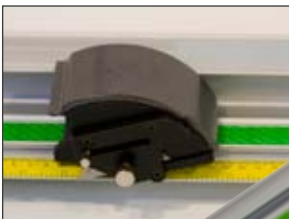

Table cutter. Blades pack included.

**Material:** Aluminium, steel.

16.041      1000mm

16.042      1500mm

## Cutting Table



1000mm or 1500mm long cutter with working table.

**Material:** Aluminium, steel.

16.033      1000mm

16.034      1500mm



## Metalic Cutter



Metalic cutter.

**Material:** Steel.

**16.063**      **Pack 5 Uni.**

## Professional Cutter



Professional cutter.

**Material:** Steel, plastic.

**16.064**      **Pack 5 Uni.**

## Rotatory Cutter



Rotatory cutter.

**Material:** Plastic, steel.

**16.065**      **Pack 5 Uni.**

## Snappy Safe Cutter



Snappy safe cutter.

**Material:** Plastic, steel.

**16.007**      **Pack 10 Uni.**

## Shears



250mm long shears for cutting aluminium sheets.

**Material:** Steel, plastic parts.

**16.069**      **250mm**

## Board Cutting Bar



Metal ruler for cutting large pieces, with finger protector. Available in different sizes: 1000mm and 2000mm.

**Material:** Aluminium.

**16.030**      **1000mm**

**16.031**      **1500mm**

**16.032**      **2500mm**

## Cutting Mat

Easy use ensures protection of the work area. Available in 5 different sizes.

**Material:** Plastic.

16.061	A5	<input type="text"/>
16.062	A4	<input type="text"/>
16.066	A3	<input type="text"/>
16.067	A2	<input type="text"/>
16.068	A1	<input type="text"/>

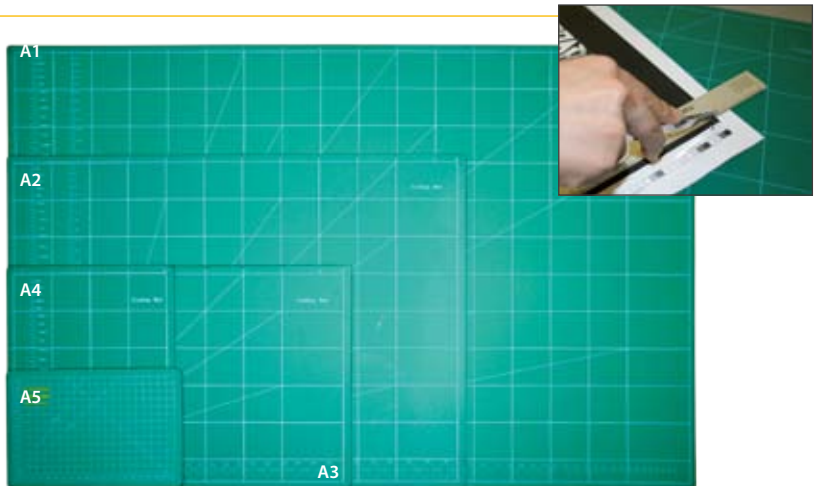

## Button Making Machine



Button making machine. Mould includes. Available in 3 different diameters.

**Material:** Steel, plastic parts.

16.131	Ø 25mm	<input type="text"/>
16.132	Ø 37mm	<input type="text"/>
16.133	Ø 58mm	<input type="text"/>

## Pin Badge Metal



Pin badge metal. Includes down shell, up shell and film. Available in 3 different diameters.

**Material:** Metal.

16.134	Ø 25mm	Pack 100 Uni.	<input type="text"/>
16.135	Ø 37mm	Pack 100 Uni.	<input type="text"/>
16.136	Ø 58mm	Pack 100 Uni.	<input type="text"/>

## Pin Badge Plastic



Pin badge plastic. Includes down shell, up shell and film. Available in 3 different diameters.

**Material:** Plastic.

16.137	Ø 25mm	Pack 100 Uni.	<input type="text"/>
16.138	Ø 37mm	Pack 100 Uni.	<input type="text"/>
16.139	Ø 58mm	Pack 100 Uni.	<input type="text"/>

## Table Eyelet Plier



Table eyelet plier.

**Material:** Steel.

16.019

## Adapters

Adapters for table eyelet plier. Available in 6mm, 8mm and 12mm.

**Material:** Steel.



16.121

Ø 6mm



16.020

Ø 8mm

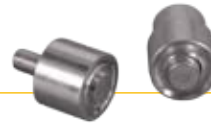

16.021

Ø 12mm

## Eyelet Plier



Eyelet plier. 100 golden eyelets included.

**Material:** Steel.

16.060

## Eyelets

Eyelets for table eyelet plier. Available in gold and silver and different sizes: 6mm, 8mm, 10mm and 12mm.

**Material:** Steel.

16.026	6mm	Pack 1000 Uni.	<input type="checkbox"/>		
16.022	6mm	Pack 1000 Uni.	<input type="checkbox"/>		
16.027	8mm	Pack 1000 Uni.	<input type="checkbox"/>		
16.023	8mm	Pack 1000 Uni.	<input type="checkbox"/>		
16.028	10mm	Pack 1000 Uni.	<input type="checkbox"/>		
16.024	10mm	Pack 1000 Uni.	<input type="checkbox"/>		
16.029	12mm	Pack 1000 Uni.	<input type="checkbox"/>		
16.025	12mm	Pack 1000 Uni.	<input type="checkbox"/>		



## Plastic Hook



Little plastic hook for holding graphics. 50mm

**Material:** Plastic.

16.036 Pack 25 Uni.

## Big Plastic Hook



Big plastic hook for holding graphics. 60mm.

**Material:** Plastic.

16.035 Pack 25 Uni.

## Corner Grips



Plastic grips for holding panels.

**Material:** Plastic.

16.127 Pack 20 Uni.

## Elastic Cord

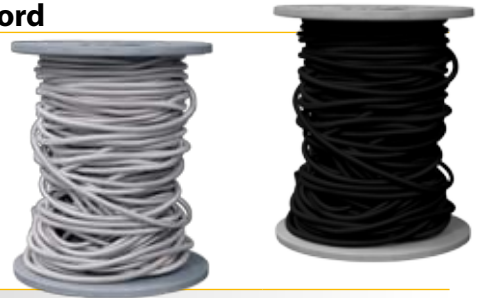

White or black elastic cord. Minimum order: 100m.

**Material:** Polyester.

16.039

16.040

## Bridles

Bridles for holding graphics, cords, cables, etc.

**Material:** Plastic.

16.043  2.5x100mm Pack 100 Uni.

16.044  2.5x100mm Pack 100 Uni.

16.045  3.6x150mm Pack 100 Uni.

16.046  3.6x150mm Pack 100 Uni.

16.047  4.8x200mm Pack 100 Uni.

16.048  4.8x200mm Pack 100 Uni.

16.049  4.8x250mm Pack 100 Uni.

16.050  4.8x250mm Pack 100 Uni.

16.051  4.8x300mm Pack 100 Uni.

16.052  4.8x300mm Pack 100 Uni.

16.053  7.2x400mm Pack 100 Uni.

16.054  7.2x400mm Pack 100 Uni.

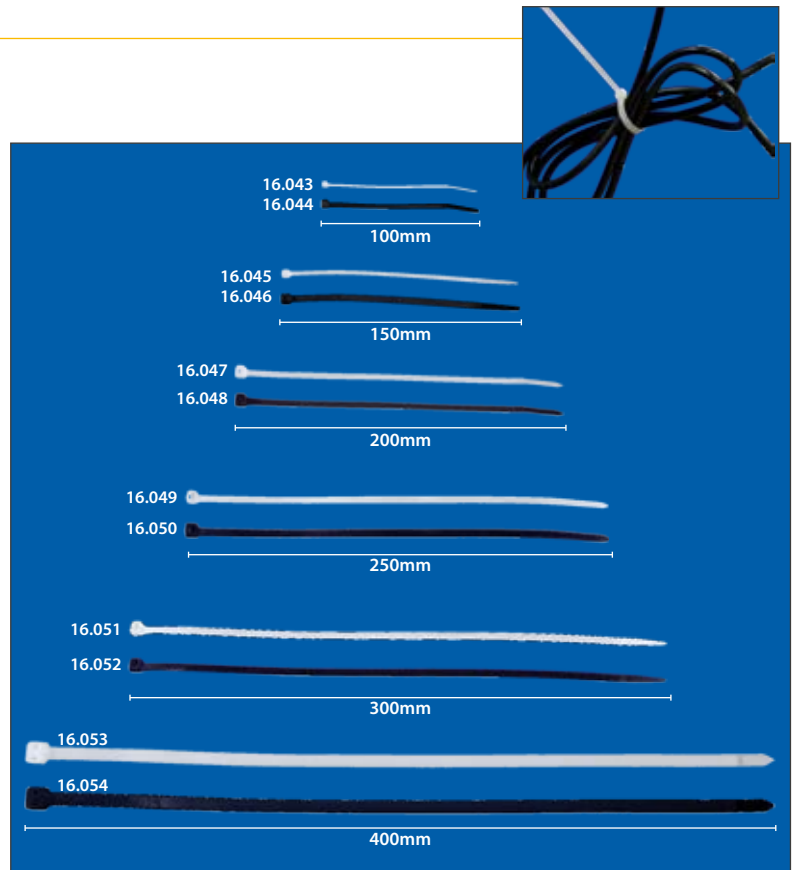

## Fishing Nylon



500m long fishing nylon. Available in 0.5 or 0.4 mm diameter.

**Material:** Nylon.

**16.037**      **Ø 0.4mm**

**16.038**      **Ø 0.5mm**

## Fishing Nylon



Blue nylon line, wire diameter: 0.5mm / 5m per roll.

**Material:** Nylon.

**12.373**      **5m**      **Pack 50 Uni.**

## Heat Gun

Heat gun application vinyl.



Voltage & Frequency:	230V ~ 50Hz
Rate power I/II:	1000/2000W
Temperature I/II:	350/550° C
Air flow I/II:	300/500 l/min.
VDE plug.	2m cable



**16.128**



Voltage & Frequency:	230V ~ 50Hz
Rate power:	2000W (Max)
Temperature I/II/III:	80/80-600/80-600°C
Air flow I/II/III:	350/350/500 l/min.
VDE plug, 2m cable.	
Adjust temperature.	



**16.129**



Voltage & Frequency:	230V ~ 50Hz
Rate power I/II:	2000W (Max)
Temperature I/II:	50/70-600/70-600°C
Air flow I/II:	300/300/500 l/min.
Display:	LCD
VDE plug, 2m cable.	



**16.130**





# RAL-COLOUR CARD

RAL 1000	RAL 1013	RAL 1027	RAL 2008	RAL 3005	RAL 3018
RAL 1001	RAL 1014	RAL 1028	RAL 2009	RAL 3007	RAL 3020
RAL 1002	RAL 1015	RAL 1032	RAL 2010	RAL 3009	RAL 3022
RAL 1003	RAL 1017	RAL 1033	RAL 2011	RAL 3011	RAL 3027
RAL 1004	RAL 1018	RAL 1034	RAL 2012	RAL 3012	RAL 3031
RAL 1005	RAL 1019	RAL 2000	RAL 3000	RAL 3013	RAL 4001
RAL 1006	RAL 1020	RAL 2001	RAL 3001	RAL 3014	RAL 4002
RAL 1007	RAL 1021	RAL 2002	RAL 3002	RAL 3015	RAL 4004
RAL 1011	RAL 1023	RAL 2003	RAL 3003	RAL 3016	RAL 4005
RAL 1012	RAL 1024	RAL 2004	RAL 3004	RAL 3017	RAL 4006
RAL 4007	RAL 5008	RAL 5019	RAL 6005	RAL 6015	RAL 6026
RAL 4008	RAL 5009	RAL 5020	RAL 6006	RAL 6016	RAL 6027
RAL 4009	RAL 5010	RAL 5021	RAL 6007	RAL 6017	RAL 6028
RAL 5000	RAL 5011	RAL 5022	RAL 6008	RAL 6018	RAL 6029
RAL 5001	RAL 5012	RAL 5024	RAL 6009	RAL 6019	RAL 6032
RAL 5002	RAL 5013	RAL 6000	RAL 6010	RAL 6020	RAL 7000
RAL 5003	RAL 5014	RAL 6001	RAL 6011	RAL 6021	RAL 7001
RAL 5004	RAL 5015	RAL 6002	RAL 6012	RAL 6022	RAL 7002
RAL 5005	RAL 5017	RAL 6003	RAL 6013	RAL 6024	RAL 7003
RAL 5007	RAL 5018	RAL 6004	RAL 6014	RAL 6025	RAL 7004
RAL 7005	RAL 7021	RAL 7035	RAL 7046	RAL 8012	RAL 8028
RAL 7006	RAL 7022	RAL 7036	RAL 7047	RAL 8014	RAL 9001
RAL 7008	RAL 7023	RAL 7037	RAL 8000	RAL 8015	RAL 9002
RAL 7009	RAL 7024	RAL 7038	RAL 8001	RAL 8016	RAL 9003
RAL 7010	RAL 7026	RAL 7039	RAL 8002	RAL 8017	RAL 9004
RAL 7011	RAL 7030	RAL 7040	RAL 8003	RAL 8019	RAL 9005
RAL 7012	RAL 7031	RAL 7042	RAL 8004	RAL 8022	RAL 9006
RAL 7013	RAL 7032	RAL 7043	RAL 8007	RAL 8023	RAL 9007
RAL 7015	RAL 7033	RAL 7044	RAL 8008	RAL 8024	RAL 9010
RAL 7016	RAL 7034	RAL 7045	RAL 8011	RAL 8025	RAL 9011
RAL 9016					
RAL 9017					
RAL 9018					

\* RAL Colour Chart is only for colour reference.

